



BOARD OF DIRECTORS
SAN LORENZO VALLEY WATER
DISTRICT
REGULAR MEETING
AGENDA
APRIL 4, 2024

MISSION STATEMENT: Our Mission is to provide our customers and future generations with reliable, safe, and high-quality water at an equitable price; to create and maintain outstanding service and community relations; to manage and protect the environmental health of the aquifers and watersheds; and to ensure the fiscal vitality of the San Lorenzo Valley Water District.

Notice is hereby given that a regular meeting of the Board of Directors of the San Lorenzo Valley Water District will be held on **Thursday, April 4, 2024, at 5:30 p.m.**, SLVWD Conference Room, 12788 Highway 9, Boulder Creek, CA, 3150 Farm Road 71 East, Dike, TX, and via videoconference and teleconference. **Open Session will begin at 6:30 p.m.**

Any person in need of any reasonable modification or accommodation to participate in the meeting may contact the District Secretary's Office at (831) 430-4636 a minimum of 72 hours before the scheduled meeting.

This meeting is being conducted as an in-person meeting under the Brown Act, Government Code section 54953, and a quorum of the Board must participate from the location(s) within the District that are identified above. Members of the public may attend the meeting at the identified location(s). Teleconferencing/videoconferencing access as set forth below is being provided as a convenience only and is not guaranteed. The meeting may continue in person even if teleconferencing/videoconferencing capability is disrupted or unavailable.

To join the meeting click the link below, or type it into your web browser.

Webinar/Public link:

<https://us02web.zoom.us/j/85144108029>

+1 346 248 7799

+1 669 900 6833

+1 253 215 8782

Webinar ID: **85144108029**

Agenda documents are available on the District website at www.slvwd.com subject to staff's ability to post the documents before the meeting.

1. Convene Meeting/Roll Call

2. Changes to Closed Session Agenda:

Additions to the Agenda, if any, may only be made in accordance with California Government Code Section 54954.2 (Ralph M. Brown Act) which includes, but is not limited to, additions for which the need to take action is declared to have arisen after the agenda was posted, as determined by a two-thirds vote of the Board of Directors (or if less than two-thirds of the members are present, a unanimous vote of those members present).

3. Oral Communications Regarding Items in Closed Session:

This portion of the agenda is reserved for Oral Communications by the public for items which are on the Closed Session portion of the Agenda. Any person may address the Board of Directors at this time, on Closed Session items. Normally, presentations must not exceed three (3) minutes in length, and individuals may only speak once during Oral Communications. No actions may be taken by the Board of Directors on any Oral Communications presented; however, the Board of Directors may request that the matter be placed on a future agenda. Please state your name and town/city of residence at the beginning of your statement for the record.

4. Adjournment to Closed Session

At any time during the regular session, the Board may adjourn to Closed Session in compliance with, and as authorized by, California Government Code Section 54956.9 and Brown Act, Government Code Section 54950. Members of the public will be given the opportunity to address any scheduled item prior to adjourning to closed session.

- a. PUBLIC EMPLOYEE MID-TERM PERFORMANCE EVALUATION
Government Code section 54957
Title: Interim District Manager

If necessary the Board of Directors may re-adjourn to Closed Session after the Open Session in order to complete the Closed Session agenda items, as allowed by the Brown Act and the District's Board Policy Manual, Section 9.A. All public comments regarding Closed Session items will be taken right after the meeting starts at 5:30 p.m.

Closed Session Note:

The Brown Act prohibits the disclosure of confidential information acquired in a closed session by any person present and offers various remedies to address willful breaches of confidentiality. These include injunctive relief, disciplinary action against an employee, and referral of a member of the legislative body to the grand jury. It is incumbent upon all those attending lawful closed sessions to protect the confidentiality of those discussions. Only the legislative body acting as a body may agree to divulge confidential closed session information; regarding attorney/client privileged communications, the entire body is the holder of the privilege and only a majority vote of the entire body can authorize the waive of the privilege.

5. Re-Convene Meeting 6:30 p.m./Roll Call
6. Report of Actions Taken in Closed Session
7. Changes to the Agenda:
Additions to the Agenda, if any, may only be made in accordance with California Government Code Section 54954.2 (Ralph M. Brown Act) which includes, but is not limited to, additions for which the need to take action is declared to have arisen after the agenda was posted, as determined by a two-thirds vote of the Board of Directors (or if less than two-thirds of the members are present, a unanimous vote of those members present).
8. Oral Communications:
This portion of the agenda is reserved for Oral Communications by the public on any subject that lies within the jurisdiction of the District and is not on the agenda. Any person may address the Board of Directors at this time. Normally, presentations must not exceed three (3) minutes in length, and individuals may only speak once. Please understand that the Brown Act limits what the Board can do regarding issues not on the agenda. No action or discussion may occur on issues outside of those already listed on today's agenda. Any Director may request that a matter raised during Oral Communication be placed on a future agenda.
9. Unfinished Business:
 - a. AMENDED AND RESTATED AGREEMENT FOR PROFESSIONAL SERVICES WITH RAFTELIS
Discussion and possible action by the Board regarding the approval of Amended and Restated Agreement for Professional Services with Raftelis for the completion of the 2023 Rate Study.
10. New Business:
 - a. 2021 CIP PIPELINE REPLACEMENT PROJECT - CHANGE ORDERS
Discussion and possible action by the Board regarding the approval of change orders (17, 18, 19 & 20) to the 2021 CIP Pipeline Project.
 - b. ALTA VIA PIPELINE REPLACEMENT PROJECT - MONAN WAY CHANGE ORDER
Discussion and possible action by the Board regarding the approval of change order (4) to the Alta Via Pipeline Replacement Project - Monan Way wall.
 - c. ALTA VIA PIPELINE REPLACEMENT PROJECT - CHANGE ORDERS
Discussion and possible action by the Board regarding the approval of change orders (10 & 11) to the Alta Via Pipeline Replacement Project.

- d. OUTREACH CONTRACT RENEWAL - MILLER MAXFIELD
Discussion and possible action by the Board regarding the contract renewal with Miller Maxfield for Outreach Services.
 - e. JULY 2024 BOARD OF DIRECTORS MEETING
Discussion and possible action by the Board regarding the possible scheduling of a July 2024 Board of Directors meeting.
11. Consent Agenda:
The Consent Agenda contains items that are considered to be routine in nature and will be deemed adopted by unanimous vote if no Director or member of the public states an objection. Any item on the consent agenda will be moved to the regular agenda upon request.
- a. PEAVINE HAZARDOUS TREE MITIGATION
 - b. LOCAL HAZARD MITIGATION PLAN CONTRACT AWARD
 - c. MID-YEAR BUDGET REVIEW
 - d. BOARD MEETING MINUTES 3.21.24
12. District Reports: None
No action will be taken and discussion may be limited at the Chairperson's discretion. The District encourages that questions be submitted in writing (bod@slvwd.com) on items listed in the District Reports. Questions submitted, if any, will be posted in the next available District Reports, along with a reply.
- DEPARTMENT QUARTERLY STATUS REPORTS
Receipt and consideration by the Board of Department Quarterly Status Reports regarding ongoing projects and other activities.
 - Engineering
 - Environmental
 - Finance
 - Operations
 - General Manager
 - COMMITTEE REPORTS
 - Future Committee Agenda Items
 - Committee Meeting Notes/Minutes
 - Budget & Finance Committee Minutes 3.13.24
 - Engineering & Environmental Committee Minutes 3.19.24
 - Administration Committee Minutes 3.27.24
13. Written Communication: None
14. Informational Material: None
15. Adjournment

Certification of Posting

I hereby certify that on March 29, 2024, I posted a copy of the foregoing agenda in the outside display case at the District Office, 13060 Highway 9, Boulder Creek, California, the SLVWD Boardroom, 12788 Highway 9, Boulder Creek, and 3150 Farm Road 71 East, Dike, TX said time being at least 72 hours in advance of the meeting of the Board of Directors of the San Lorenzo Valley Water District (Government Code Section 54954.2).
Executed at Boulder Creek, California on March 29, 2024.

Holly B. Hossack, District Secretary

MEMO

DATE: April 4, 2024
TO: Board of Directors, San Lorenzo Valley Water District
FROM: Brian Frus, Interim General Manager
SUBJECT: Amended and Restated Agreement for Professional Services
with Raftelis for the Completion of the 2023 Rate Study

WRITTEN BY: Heather Ippoliti, Consultant (RGS)

PRESENTED BY: Heather Ippoliti, Consultant (RGS)

STAFF RECOMMENDATION

It is recommended that the Board of Directors approve the amended and restated agreement with Raftelis to extend the term and increase the not-to-exceed contract amount.

RECOMMENDED MOTION

The Board:

1. Directs the Interim General Manager to enter into an amended and restated agreement with Raftelis in an amount not to exceed \$119,120 for the completion of the 2023 Rate Study; and
2. Authorizes the Interim General Manager to execute extensions and/or non-substantive modifications to the Agreement, as necessary.

BACKGROUND

On March 30, 2023, the Board directed the General Manager to enter into a contract with Raftelis for the completion of the 2023 Rate Study. The agreement was entered into as of April 21, 2023, with an amount not to exceed \$99,035, and an expiration date of November 30, 2023.

Raftelis is requesting a change of an additional \$20,085 increasing the not-to-exceed amount from \$99,035 to \$119,120. Attached is a letter received by the District from Raftelis dated March 28, 2024, detailing the additional work completed outside the agreed upon scope, and the remaining work to be completed as of the date of the letter. These include:

- Participation in additional Board meetings
- Consideration of additional capital improvement program scenarios
- Wholesale pricing support
- Assistance responding to public records request
- Additional requested analyses
- Preparation of additional drafts of the report

Regarding the additional Board meetings, the RFP stated “about five meetings” with district staff plus four additional meetings: one public outreach, one Budget and Finance Committee, one Board meeting and one Public Hearing. Raftelis participated in a total of 23 staff meetings, one Committee meeting, and seven Board meetings.

Attached is the requested detail of the additional fees in proposal format. Raftelis continues to provide assistance; most recently related to the development of the wholesale intertie rates and it is anticipated that the District will require additional assistance in implementing the rates as adopted and will seek Raftelis’ guidance. If approved, the District will only be billed for actual time spent, up to \$119,120.

As required by the original scope of work, Raftelis has provided the parameter driven budgeting worksheet and suggestions on the layout of the utility bill.

The term of the original agreement has also expired. The amended and restated agreement will extend the term until September 30, 2024.

Attached is the draft amended and restated agreement.

PRIOR COMMITTEE ACTION

No prior committee action was taken on this matter.

FISCAL IMPACT

As of January 31, 2024, the Administration Department has spent 68% of the approved FY 2023-24 department budget, of which \$94,320 was invoices to Raftelis or 6% of the department budget. No budget amendment is proposed. Based on current year-to-date expenses, there is sufficient department budget to cover the proposed increased expense of \$20,085.

ENVIRONMENTAL IMPACT

Pursuant to Title 14, the California Code of Regulations, Section 15302(c) of the California Environmental Quality Act (“CEQA”) guidelines, the proposed action is an administrative activity of the District that will not result in direct or indirect physical changes to the environment.

ATTACHMENTS

- Letter to the District dated March 28, 2024, from Raftelis with updated fee sheet in proposal format
- Letter to the District dated October 12, 2023, from Raftelis
- Draft amended and restated agreement



March 28, 2024

Mr. Brian Frus, PE
Interim General Manager
San Lorenzo Valley Water District
13060 Highway 9
Boulder Creek, CA 95006

Subject: Additional Funds Request

Dear Mr. Frus:

Raftelis is respectfully requesting an increase to the rate study budget of \$20,085. This is to help cover expenses related to additional work that has been done throughout the duration of the study, including the following:

- Four Board meetings instead of one
- Additional capital improvement program scenarios
- Wholesale pricing
- Responding to public records request
- Additional requested analyses
- Additional drafts of the report

This amount also includes estimated time for continued work on wholesale pricing and to develop wholesale/standby charges for Scotts Valley.

The additional work requested by the District in September was previously documented with Kendra Reed on October 13, 2023, before her departure. At that time, we noted that we would continue to track any additional out-of-scope work for this project.

An updated fee schedule is attached. If you need any other information to process this request, please let us know. We appreciate your attention to this matter and the opportunity for our firm to continue to provide assistance to the District on this important project.

Sincerely,

A handwritten signature in black ink that reads "Theresa M. Jurotich".

Theresa Jurotich, P.E., PMP

Manager

P: 206.707.9155 / E: tjurotich@raftelis.com

A handwritten signature in black ink that reads "Melissa E. Elliott".

Melissa Elliott

Executive Vice President

P: 303.305.1141 / E: melliott@raftelis.com

Tasks	Web Meetings - Staff	Web Meetings - Board/Committees	Hours					Total Fees & Expenses
			PD	TR	PM	SC	Total	
1. Project Management	1		5	5	20	15	45	\$11,100
2. Revenue Requirements and Rate Schedule	4	1	30	15	60	80	185	\$44,825
- additional financial plan scenarios & extra board meeting	5	3	4	1		20	25	\$5,235
- additional meetings/support/analysis	3		7	3	68	7	85	\$22,310
3. Final Rate Study Report and Public Meetings	3	4	8	6	60		74	\$20,250
Additional - Wholesale Intertie	1		7		20		27	\$7,720
Additional - School Bills					4		4	\$1,040
Additional Revisions to Presentations & Report	6		4		20		24	\$6,640
Total Meetings / Hours	23	8	65	30	252	122	469	
Hourly Billing Rate			\$350	\$285	\$250	\$165		
Total Professional Fees			\$22,750	\$8,550	\$63,000	\$20,130	\$114,430	
							Total Fees	\$114,430
							Total Expenses	\$4,690
							Total Fees & Expenses	\$119,120

PD - Project Director
 TR - Technical Reviewer
 PM - Project Manager
 SC - Staff Consultant
 Tech Charge = \$10/hr



October 12, 2023

Ms. Kendra Reed
Finance Director
San Lorenzo Valley Water District
13060 Highway 9
Boulder Creek, CA 95006

Subject: Additional Financial Plan Efforts

Dear Ms. Reed:

With the transitions happening at San Lorenzo Valley Water District (District), we wanted to document the additional, out-of-scope work that has been done to date.

- Second financial plan Board meeting & updated presentation
- Additional capital improvement program scenarios

It took approximately 20 hours of our analyst's time and 4 hours of our senior subject matter expert and technical reviewer's time. This letter is to document that the District requested this work. We'll continue to track any additional out-of-scope work for this project and can present your successor with a change order that includes this work as we get further into the project.

We appreciate your attention to orienting the District's next rate study project manager about this additional effort and the opportunity for our firm to continue to provide assistance to the District on this important project. We wish you the best in your new position.

Sincerely,

A handwritten signature in black ink that reads "Melissa Elliott".

Melissa Elliott

Executive Vice President

P: 303.305.1141 / E: melliot@raftelis.com

AMENDED AND RESTATED AGREEMENT FOR PROFESSIONAL SERVICES
by and between
SAN LORENZO VALLEY WATER DISTRICT
and
RAFTELIS FINANCIAL CONSULTANTS, INC.

CONTRACT NO. 22/23-16

2023 RATE STUDY

Scope of study to include a cost of service analysis for water and sewer services and recommendations related to rates to be implemented by the District.

PREAMBLE

This amended and restated agreement for the performance of professional services (“Agreement”) is made and entered into as of this **4th day of April 2024**, by and between Raftelis Financial Consultants, Inc., a North Carolina corporation, with its principal place of business located at 227 West Trade St., Suite 1400, Charlotte, NC 28202, hereinafter referred to as “Consultant,” and the San Lorenzo Valley Water District, a California County Water District, with its principal place of business located at 13060 Highway 9, Boulder Creek, CA 95006, hereinafter referred to as “District.” District and Consultant may be referred to individually as a “Party” or collectively as the “Parties.”

RECITALS

- A. WHEREAS, on February 9, 2023, District issued a Request for Proposals for analysis of cost and projected rate schedule; and
- B. WHEREAS, Consultant represents and warrants that it possesses the professional qualifications and expertise required by District as set forth under the Request for Proposals and this Agreement.

Now, THEREFORE, the Parties mutually agree as follows:

1. SCOPE OF SERVICES

- A. Consultant agrees to perform the services (the “Services”) provided for in **Exhibits A and C**, entitled “Project Scope of Services” attached hereto and incorporated herein. Except as otherwise specified in this Agreement, Consultant shall furnish all technical, legal and professional services, including labor, material, equipment, transportation, supervision and expertise to satisfactorily complete the Services at Consultant’s sole risk and expense.
- B. Consultant shall be responsible for the quality, technical accuracy, and coordination of Services furnished by it under this Agreement. Consultant will provide the Services in a manner consistent with the level of care and skill ordinarily exercised by other professionals providing the same or similar services

in the region. Consultant shall be solely responsible to District for the performance of Consultant, and any of its employees, agents, subcontractors, subconsultants, or suppliers, that provide any Services or work under this Agreement.

2. TERM OF AGREEMENT

This agreement shall be deemed to have commenced on April 21, 2023 (“Effective Date”). Consultant shall provide the Services commencing upon the Effective Date and shall complete the Services by September 30, 2024. Any extension shall be by amendment.

3. CONSULTANT COMPENSATION

- A. Consultant shall bill District on a monthly basis for any Services provided by Consultant during the preceding month, pursuant to the rates set forth in **Exhibit D**, attached hereto and incorporated herein, as well as, additional services noted in **Exhibit C**. In no event shall the amount of this Agreement exceed **\$119,120**. Any increase of this not-to-exceed amount shall be by amendment.
- B. Consultant may begin Services prior to the execution and the Effective Date of this Agreement solely at its own risk, with the understanding that District may elect in its sole and absolute discretion whether or not to compensate Consultant for any Services so provided.

4. GUARANTEED MAXIMUM COSTS

- A. District’s obligation hereunder shall not at any time exceed the amount of this Agreement as stated herein. Any increase of the not-to-exceed amount shall be by amendment.
- B. Officers and employees of District are not authorized to request, and District is not required to reimburse Consultant for, commodities or services beyond the agreed upon scope of Services unless the changed scope is authorized by amendment.
- C. Officers and employees of District are not authorized to offer or promise, nor is District required to honor, any offered or promised additional funding in excess of the maximum amount of funding for which the contract is authorized without an amendment authorizing additional funding.

5. PAYMENT; INVOICE FORMAT

- A. Invoices furnished by Consultant under this Agreement must be in a form acceptable to the District Manager or designee.
- B. Payment shall be made by District to Consultant at the address specified in the Section entitled “Notices to the Parties.”
- C. District may withhold payment in any instance in which Consultant has failed or refused to satisfy any material obligation provided for under this Agreement.

- D. Payment by District typically will be made within thirty (30) days of the date of receipt of Consultant's invoice by District. However, in no event shall District be liable for interest or late charges for any late payments.

6. PAYMENT DOES NOT IMPLY ACCEPTANCE OF WORK

The granting of any payment by District, or the receipt thereof by Consultant, shall in no way lessen the liability of Consultant to replace unsatisfactory work, equipment, or materials, although the unsatisfactory character of such work, equipment or materials may not have been apparent or detected at the time such payment was made. Materials, equipment, components, or workmanship that do not conform to the requirements of this Agreement may be rejected by District and in such case must be replaced by Consultant without delay. This Section shall survive termination of this Agreement.

7. GRANT REQUIREMENTS

[Intentionally omitted.]

8. DISALLOWANCE

[Intentionally omitted.]

9. QUALIFIED PERSONNEL

Services and work under this Agreement shall be performed only by competent personnel under the supervision of and in the employment of Consultant, except as may be allowed pursuant to the Section of this Agreement entitled "Subcontracting." Consultant will comply with District's reasonable requests regarding assignment of personnel, but all personnel, including those assigned at Districts' request, must be supervised by Consultant. Consultant shall commit adequate resources to complete the project within the project schedule specified in this Agreement.

10. SUBCONTRACTING

- A. Consultant is prohibited from subcontracting this Agreement or any part of it unless such subcontracting is first approved by District in writing. Neither Party shall, on the basis of this Agreement, contract on behalf of or in the name of the other Party. An agreement made in violation of this provision shall confer no rights on any Party and shall be null and void.
- B. Nothing contained in this Agreement or otherwise, shall create any contractual relation between District and any subcontractors or subconsultant, and no subcontract shall relieve Consultant of its responsibilities and obligations hereunder. Consultant agrees to be as fully responsible to District for the acts and omissions of its subcontractors or subconsultants and of persons either directly or indirectly employed by any of them as it is for the acts and omissions of persons directly employed by the Consultant. Consultants' obligation to pay its subcontractors or subconsultants is an independent obligation from Districts' obligation to make payments to Consultant.

- C. Any subcontract entered into as a result of this Agreement, shall contain all the applicable grant requirements and provisions stipulated in this Agreement to be applicable to subcontractors or subconsultants.
- D. Any substitution of subcontractors or subconsultants must be approved in writing by District advance of assigning work to a substitute subcontractor or subconsultant.

11. PROMPT PROGRESS PAYMENT TO SUBCONSULTANTS

A prime consultant shall pay to any subcontractor or subconsultant not later than seven days of receipt of each progress payment by District, in accordance with the provision in Section 7108.5 of the California Business and Professions Code concerning prompt payment to subconsultants. The 7-day period is applicable unless a longer period is agreed to in writing. Prime consultants are prohibited from holding retainage from subcontractors or subconsultants. Any violation of Section 7108.5 shall subject the violating consultant to the penalties, sanctions, and other remedies of that Section. This requirement shall not be construed to limit or impair any contractual, administrative, or judicial remedies, otherwise available to the prime consultant in the event of a dispute involving a late payment or nonpayment, deficient subconsultant or subcontractor performance, and/or noncompliance by a subconsultant or subcontractor.

12. PROPRIETARY OR CONFIDENTIAL INFORMATION OF DISTRICT

Consultant understands and agrees that, in the performance of the work or Services under this Agreement or in contemplation thereof, Consultant may have access to private or confidential information which may be owned or controlled by District and that such information may contain proprietary or confidential details, the disclosure of which to third parties may be damaging to District. Consultant agrees that all information marked "confidential" disclosed by District to Consultant shall be held in confidence and used only in performance of the Agreement. Consultant shall exercise the same standard of care to protect such information as a reasonably prudent contractor would use to protect its own proprietary data. Nothing furnished to Consultant that is otherwise generally known to the public or is of public record, or required to be disclosed by court order, legal process or applicable law, shall be deemed confidential under this Section. This Section shall survive termination of this Agreement.

13. OWNERSHIP OF RESULTS

All drawings, plans, specifications, blueprints, studies, reports, memoranda, computation sheets, computer files and media or other documents prepared by Consultant or its subcontractors or subconsultants in connection with services to be performed under this Agreement, shall become the property of and will be transmitted to District. However, Consultant may retain and use copies for reference and as documentation of its experience and capabilities. This Section shall survive termination of this Agreement. Nothing contained herein shall be deemed a transfer, assignment or divestiture by Consultant of its trade secrets, know-how or intellectual property.

14. WORKS FOR HIRE

[Intentionally omitted.]

15. INSURANCE REQUIREMENTS

A. Without in any way limiting Consultant's liability pursuant to the Section of this Agreement entitled "Hold Harmless/Indemnification," Consultant must maintain in force, during the full term of the Agreement, insurance in the following amounts and coverages:

1. Commercial General Liability Insurance with limits not less than \$1,000,000 each occurrence Combined Single Limit for Bodily Injury and Property Damage, including Contractual Liability, Personal Injury, Products and Completed Operations; and
2. Workers' Compensation, in statutory amounts, with Employers' Liability Limits not less than \$1,000,000 each accident; and
3. Commercial Automobile Liability Insurance with limits not less than \$1,000,000 each occurrence Combined Single Limit for Bodily Injury and Property Damage, including Owned, Non-Owned and Hired auto coverage, as applicable; and
4. Professional Liability Insurance with limits not less than \$2,000,000 per claim. Subconsultants or subcontractors providing professional services under this Agreement, if any, shall be added to Consultant's policy as additional insured, or shall provide evidence of their own professional liability insurance which is acceptable to District.
5. Commercial General Liability and Business Automobile Liability insurance policies must provide the following:
 - (a) Name as Additional Insured the District, its Officers, Agents, and Employees; and
 - (b) That such policies are primary insurance to any other insurance available to the Additional Insureds, with respect to any claims

arising out of this Agreement, and that insurance applies separately to each insured against whom claim is made or suit is brought.

- B. All policies required by this Agreement shall provide thirty days' advance written notice to District of cancellation at the address specified in the Section of this Agreement entitled "Notices to the Parties."
- C. Should any of the required insurance be provided under a claims-made form, Consultant shall maintain such coverage continuously throughout the term of this Agreement and, without lapse, for a period of three years beyond the expiration of this Agreement, to the effect that, should occurrences during the term give rise to claims made after expiration of the Agreement, such claims shall be covered by such claims-made policies.
- D. Should any of the required insurance be provided under a form of coverage that includes a general annual aggregate limit or provides that claims investigation or legal defense costs be included in such general annual aggregate limit, such general annual aggregate limit shall be double the occurrence or claims limits specified above.
- E. Should any required insurance lapse during the term of this Agreement, requests for payments originating after such lapse shall not be processed until District receives satisfactory evidence of reinstated coverage as required by this Agreement, effective as of the lapse date. If insurance is not reinstated, District may, at its sole option, terminate this Agreement effective on the date of such lapse of insurance.
- F. Prior to commencement of any work or Services under this Agreement, Consultant, shall, at its sole cost and expense, furnish to District certificates of insurance, and additional insured policy endorsements, in form and with insurers satisfactory to District, evidencing all coverages set forth above, and shall furnish complete copies of policies promptly upon District's request.
- G. Approval of the insurance by District shall not relieve or decrease the liability of Consultant hereunder. This subsection shall survive termination of this Agreement.

16. RESPONSIBILITY FOR EQUIPMENT

District shall not be responsible for any damage to persons or property as a result of the use, misuse or failure of any equipment used by Consultant, or by any of its employees or agents, even though such equipment be furnished, rented or loaned to Consultant by District. This Section shall survive termination of this Agreement.

17. CORRECTION OF SERVICES

District may elect in its sole and absolute discretion, to give Consultant the opportunity to correct any incomplete, inaccurate or defective Services, and Consultant hereby agrees, if given such opportunity pursuant District's election under this Section, to correct such

Services at no further cost to District, when such defects are due to the negligence, errors or omissions of Consultant. This Section shall survive termination of this Agreement.

18. HOLD HARMLESS/INDEMNIFICATION

- A. Consultant shall indemnify and hold harmless District and its officers, agents and employees from loss, damage, injury, liability, damages, judgments, claims caused by the negligence, gross negligence or willful misconduct by Consultant in the course of Consultant's performance of this Agreement, regardless of whether liability without fault is imposed or sought to be imposed on District, except to the extent that such indemnity is void or otherwise unenforceable under applicable law, and except where such loss, damage, injury, liability or claim is the result of the active negligence or willful misconduct of District and is not contributed to by any act or omission of Consultant, its subcontractors or subconsultants or their agent or employee. The foregoing indemnity shall include, without limitation, reasonable fees of attorneys, consultants and experts and related costs.
- B. Consultant shall indemnify and hold District harmless from all loss and liability, including attorneys' fees, court costs and all other litigation expenses for any infringement by Consultant of the U.S. patent rights, copyright, trade secret or any other proprietary right or trademark, and all other intellectual property claims of any person or persons in consequence of the use by District, or any of its officers or agents, of articles or services to be supplied in the performance of this Agreement.
- C. This Section 18 shall survive termination of this Agreement.

19. INCIDENTAL AND CONSEQUENTIAL DAMAGES

[Intentionally omitted.]

20. LIABILITY OF DISTRICT

District's payment obligations under this Agreement shall be limited to the payment of the compensation provided for in the Section of this Agreement entitled "Consultant Compensation." Notwithstanding any other provision of this Agreement, in no event shall District be liable, regardless of whether any claim is based on contract or tort, for any special, consequential, indirect or incidental damages, including, but not limited to, lost profits, arising out of or in connection with this Agreement or Services performed in connection with this Agreement. This Section shall survive termination of this Agreement.

21. DEFAULT; REMEDIES

- A. Each of the following shall constitute an event of default ("Event of Default") under this Agreement:

1. Consultant fails or refuses to perform or observe any term, covenant or condition contained in any of the following Sections of this Agreement: 7 ("Grant Requirements"), 9 ("Qualified Personnel"), 10 ("Subcontracting"), 12 ("Proprietary or Confidential Information of District"), 15 ("Insurance Requirements"), 17 ("Correction of Services"), 27 ("Compliance with Laws"), 28 ("Fair Employment"), 29 ("Compliance with Americans with Disabilities Act"), 30 ("Drug Free Workplace"), 31 ("Submitting False Claims; Monetary Penalties"), or 38 ("Assignment").
 2. Consultant fails or refuses to perform or observe any other term, covenant or condition contained in this Agreement, and such default continues for a period of ten days after written notice thereof from District to Consultant.
 3. Consultant (i) is generally not paying its debts as they become due, (ii) files, or consents by answer or otherwise to the filing against it of, a petition for relief or reorganization or arrangement or any other petition in bankruptcy or for liquidation or to take advantage of any bankruptcy, insolvency or other debtors' relief law of any jurisdiction, (iii) makes an assignment for the benefit of its creditors, (iv) consents to the appointment of a custodian, receiver, trustee or other officer with similar powers of Consultant or of any substantial part of Consultant's property or (v) takes action for the purpose of any of the foregoing.
 4. A court or government authority enters an order (A) appointing a custodian, receiver, trustee or other officer with similar powers with respect to Consultant or with respect to any substantial part of Consultant's property, (B) constituting an order for relief or approving a petition for relief or reorganization or arrangement or any other petition in bankruptcy or for liquidation or to take advantage of any bankruptcy, insolvency or other debtors' relief law of any jurisdiction or (C) ordering the dissolution, winding-up or liquidation of Consultant.
- B. On and after any Event of Default, District shall have the right to exercise its legal and equitable remedies, including, without limitation, the right to terminate this Agreement or to seek specific performance of all or any part of this Agreement. In addition, District shall have the right (but no obligation) to cure (or cause to be cured) on behalf of Consultant any Event of Default; Consultant shall pay to District on demand all costs and expenses incurred by District in effecting such cure, with interest thereon from the date of incurrence at the maximum rate then permitted by law. District shall have the right to offset from any amounts due to Consultant under this Agreement or any other agreement between District and Consultant all damages, losses, costs or expenses incurred by District as a result of such Event of Default and any liquidated damages due from Consultant pursuant to the terms of this Agreement or any other agreement. This subsection shall survive termination of this Agreement.
- C. All remedies provided for in this Agreement may be exercised individually or in combination with any other remedy available hereunder or under applicable laws, rules and regulations. The exercise of any remedy shall not preclude or in any way

be deemed to waive any other remedy. This subsection shall survive termination of this Agreement.

22. EARLY TERMINATION FOR CONVENIENCE

- A. District shall have the option, in its sole discretion, to terminate this Agreement, at any time during the term hereof, for convenience and without cause. District shall exercise this option by giving Consultant written notice of termination. The notice shall specify the date on which termination shall become effective.
- B. Upon receipt of the notice, Consultant shall commence and perform, with diligence, all actions necessary on the part of Consultant to effect the termination of this Agreement on the date specified by District and to minimize the liability of Consultant and District to third parties as a result of termination. All such actions shall be subject to the prior approval of District. Such actions shall include, without limitation:
1. Halting the performance of all Services and other work under this Agreement on the date(s) and in the manner specified by District.
 2. Not placing any further orders or subcontracts for materials, services, equipment or other items.
 3. Terminating all existing orders and subcontracts.
 4. At District's direction, assigning to District any or all of Consultant's right, title, and interest under the orders and subcontracts terminated. Upon such assignment, District shall have the right, in its sole discretion, to settle or pay any or all claims arising out of the termination of such orders and subcontracts.
 5. Subject to District's approval, settling all outstanding liabilities and all claims arising out of the termination of orders and subcontracts.
 6. Completing performance of any Services or work that District designates to be completed prior to the date of termination specified by District.
 7. Taking such action as may be necessary, or as District may direct, for the protection and preservation of any property related to this Agreement which is in the possession of Consultant and in which District has or may acquire an interest.
- C. Within 30 days after the specified termination date, Consultant shall submit to District a final invoice for Services performed under the Agreement.
- D. In no event shall District be liable for costs incurred by Consultant or any of its subcontractors or subconsultants after the termination date specified by District.

- E. In arriving at the amount due to Consultant under this Section 22, District may deduct: (1) all payments previously made by District for work or other Services covered by Consultant's final invoice; (2) any claim which District may have against Consultant in connection with this Agreement; (3) any invoiced costs or expenses excluded pursuant to the immediately preceding subsection; and (4) in instances in which, in the opinion of District, the cost of any Service or other work performed under this Agreement is excessively high due to costs incurred to remedy or replace defective or rejected Services or other work, the difference between the invoiced amount and District's estimate of the reasonable cost of performing the invoiced Services or other work in compliance with the requirements of this Agreement.
- F. District's payment obligation under this Section 22 shall survive termination of this Agreement.

23. RIGHTS AND DUTIES UPON TERMINATION OR EXPIRATION

Upon any termination of this Agreement prior to expiration of the term specified in Section 2 (entitled "Term of Agreement") this Agreement shall terminate and be of no further force or effect except as otherwise expressly provided herein. Upon payment by District of all sums owing to Consultant, Consultant shall transfer title to District, and deliver in the manner, at the times, and to the extent, if any, directed by District, any work in progress, completed work, supplies, equipment, and other materials produced as a part of, or acquired in connection with the performance of this Agreement, and any completed or partially completed work which, if this Agreement had been completed, would have been required to be furnished to District. This Section shall survive termination of this Agreement.

24. LIQUIDATED DAMAGES

[Intentionally omitted.]

25. AUDIT AND INSPECTION OF RECORDS OF CONSULTANT

Consultant agrees to maintain and make available to District, during regular business hours, accurate books and accounting records relating to its work under this Agreement. Consultant will permit District to audit, examine and make excerpts and transcripts from such books and records, and to make audits of all invoices, materials, payrolls, records or personnel and other data related to all other matters covered by this Agreement, whether funded in whole or in part under this Agreement. Consultant shall maintain such data and records in an accessible location and condition for a period of not less than three years after final payment under this Agreement or until after final audit has been resolved, whichever is later. The State of California or any federal agency having an interest in the subject matter of this Agreement shall have the same rights conferred upon District by this Section. This Section shall survive termination of this Agreement.

26. CONFLICT OF INTEREST

Consultant acknowledges that it is familiar with the provisions of §87100 et seq. of the Government Code of the State of California, and certifies that it does not know of any facts which constitute a violation of said provisions.

27. COMPLIANCE WITH LAWS

Consultant shall keep itself fully informed of all local laws and regulations applicable to District, and of all state, and federal laws affecting the performance of this Agreement, Consultant must at all times comply with such local laws and regulations and all applicable state and federal laws as they may be amended from time to time.

28. FAIR EMPLOYMENT

During the performance of the Agreement, Consultant shall not discriminate against any person or group of persons on account of race, religious creed, color, national origin, ancestry, physical disability, mental disability, medical condition, genetic information, marital status, sex, gender, gender identity, gender expression, age, sexual orientation, or any other category or characteristic protected by law. Consultant confirms that it has an equal employment opportunity policy ensuring equal employment opportunity without regard to race, religious creed, color, national origin, ancestry, physical disability, mental disability, medical condition, genetic information, marital status, sex, gender, gender identity, gender expression, age, or sexual orientation; and that it maintains no employee facilities segregated on the basis of race, religious creed, color, national origin, ancestry, physical disability, mental disability, medical condition, genetic information, marital status, sex, gender, gender identity, gender expression, age, sexual orientation, and any other category or characteristic protected by law. Consultant further agrees that any violation of this prohibition on the part of Consultant, its employees, agents or assigns will constitute a material breach of this Agreement.

29. COMPLIANCE WITH AMERICANS WITH DISABILITIES ACT

Consultant acknowledges that, pursuant to the Americans with Disabilities Act (ADA), programs, services and other activities provided by a public entity to the public, whether directly or through a contractor, must be accessible to the disabled public. Consultant shall provide the services specified in this Agreement in a manner that complies with the ADA and any and all other applicable federal, state and local disability rights legislation. Consultant agrees not to discriminate against, or fail to make reasonable accommodation of any person covered by the ADA, or fail to comply with any provision of the ADA in the course of its performance of its obligations under the Agreement, or in any way connected with District. Consultant shall defend, indemnify, protect, and hold harmless the District its directors, officers, employees, agents, or authorized volunteers, and each of them, from any and all damages, losses, claims, suits, costs, liabilities, or actions of every kind or description (including attorneys' fees) incurred or brought for, or on account of, Consultant's violation or alleged violation of the ADA in the course of performance of its obligations under the Agreement, or in any way connected to District. Consultant further agrees that any violation of this prohibition on the part of Consultant, its employees, agents or assigns will constitute a material breach of this Agreement.

30. DRUG FREE WORKPLACE

Consultant acknowledges that the unlawful manufacture, distribution, dispensation, possession, or use of a controlled substance is prohibited on District premises. Consultant agrees that any violation of this prohibition by Consultant, its employees, agents or assigns will be deemed a material breach of this Agreement.

31. SUBMITTING FALSE CLAIMS; MONETARY PENALTIES

Pursuant to California Government Code Sections 12650 et seq., any contractor, subcontractor or consultant who submits a false claim shall be liable to District for three times the amount of damages that District sustains because of the false claim. A contractor, subcontractor or consultant who submits a false claim shall also be liable to District for the costs of a civil action brought to recover any of those penalties or damages, and may be liable to District for a civil penalty for up to \$10,000 for each false claim. A contractor, subcontractor or consultant will be deemed to have submitted a false claim to District if the contractor, subcontractor or consultant: (a) knowingly presents or causes to be presented to an officer or employee of District, a false claim for payment or approval; (b) knowingly makes, uses or causes to be made or used a false record or statement to get a false claim paid or approved by District; (c) conspires to defraud District by getting a false claim allowed or paid by District; (d) has possession, custody, or control of public property or money used or to be used by District and knowingly delivers or causes to be delivered less property than the amount for which the person receives a certificate or receipt; (e) is authorized to make or deliver a document certifying receipt of property used or to be used by District and knowingly makes or delivers a receipt that falsely represent the property used or to be used; (f) knowingly makes, uses, or causes to be made or used a false record or statement to conceal, avoid, or decrease an obligation to pay or transmit money or property to District; (g) is a beneficiary of an inadvertent submission of a false claim to District, subsequently discovers the falsity of the claim, and fails to disclose the false claim to District within a reasonable time after discovery of the false claim. This Section shall survive termination of this Agreement.

32. FORCE MAJEURE

The time for performance of Services to be rendered pursuant to this Agreement may be extended because of any delays due to unforeseeable causes beyond the control and without the fault or negligence of Consultant, including, but not restricted to, acts of God or of any public enemy, acts of the government, fires, earthquakes, floods, epidemic, quarantine restrictions, riots, strikes, freight embargoes and unusually severe weather if Consultant, within ten (10) days of the commencement of such condition, notifies the District Manager who shall thereupon ascertain the facts and extent of any necessary delay, and may extend the time for performing Services. The District Managers' determination shall be final and conclusive upon the Parties to this Agreement.

33. ENTIRE AGREEMENT

This contract sets forth the entire Agreement between the Parties in connection with the subject matter hereof, and supersedes any and all other oral or written communications or provisions. This contract may be modified or amended only as provided in the Section

directly below, entitled "Amendments." This Section shall survive termination of this Agreement.

34. AMENDMENTS

It is mutually understood and agreed that this Agreement may not be amended or modified, nor may compliance with any of its terms be waived, except by written instrument executed and approved in the same manner as this Agreement. This Section shall survive termination of this Agreement.

35. NON-WAIVER

The omission by either Party at any time to enforce any default or right reserved to it, or to require performance of any of the terms, covenants, or provisions hereof by the other Party at the time designated, shall not be a waiver of any such default or right to which the Party is entitled, nor shall it in any way affect the right of the Party to enforce such provisions thereafter. This Section shall survive termination of this Agreement.

36. NO AGENCY

Consultant shall not have authority, expressed or implied, to act on behalf of District as an agent, or to bind District to any obligations whatsoever, unless specifically authorized in writing by the District Manager. This Section shall survive termination of this Agreement.

37. CONSULTANT IS AN INDEPENDENT CONTRACTOR

A. Consultant or any agent or employee of Consultant shall be deemed at all times to be an independent contractor and is wholly responsible for the manner in which it performs the services and work requested by District under this Agreement. Consultant or any agent or employee of Consultant is liable for the acts and omissions of itself, its employees and its agents. Nothing in this Agreement shall be construed as creating an employment or agency relationship between District and Consultant or any agent or employee of Consultant.

B. Any terms in this Agreement referring to direction from District shall be construed as providing for direction as to policy and the result of Consultant's work only, and not as to the means by which such a result is obtained. District does not retain the right to control the means or the method by which Consultant performs Services or work under this Agreement.

C. This Section 37 shall survive termination of this Agreement.

38. ASSIGNMENT

The Services to be performed by Consultant are personal in character and neither this Agreement nor any duties or obligations hereunder may be assigned or delegated by the Consultant unless first approved by District by written instrument executed and approved in the same manner as this Agreement. This Section shall survive termination of this Agreement.

39. CONSTRUCTION

All section headings are for reference only and shall not be considered in construing this Agreement. No provision of this Agreement shall be construed against any Party hereto by reason of such Party's being deemed to have drafted such provisions. This Section shall survive termination of this Agreement.

40. SEVERABILITY

Should the application of any provision of this Agreement to any particular facts or circumstances be found by a court of competent jurisdiction to be invalid or unenforceable, then (a) the validity of other provisions of this Agreement shall not be affected or impaired thereby, and (b) such provision shall be enforced to the maximum extent possible so as to effect the intent of the parties and shall be reformed without further action by the Parties to the extent necessary to make such provision valid and enforceable. This Section shall survive termination of this Agreement.

41. NOTICE TO THE PARTIES

Unless otherwise indicated elsewhere in this Agreement, all written communications sent by the Parties shall be sent via email with a copy by U.S. mail or by express overnight courier with tracking, addressed as follows:

To District:

Brian Frus
Interim General Manager
San Lorenzo Valley Water District
13060 Highway 9
Boulder Creek, CA 95006
[Email: bfrus@slvwd.com](mailto:bfrus@slvwd.com)

To Consultant:

Theresa Jurotich
445 South Figueroa St., Suite 1925
Los Angeles, CA 90017
[Email: tjurotich@raftelis.com](mailto:tjurotich@raftelis.com)

Any notice of default must be sent by email with a copy by registered mail or by express overnight courier with tracking.

42. ADMINISTRATIVE REMEDY FOR AGREEMENT INTERPRETATION

Should any question arise as to the meaning and intent of this Agreement, the question shall, prior to any other action or resort to any other legal remedy, be referred to District's General Manager, who shall decide the true meaning and intent of the Agreement. This Section shall survive termination of this Agreement. No decision by the General Manager shall have any evidentiary effect or bind in any way a court or other tribunal.

43. DISPUTE RESOLUTION

- A. District may elect in its sole and absolute discretion to submit any controversies between Consultant and District regarding the construction or application of this Agreement, and claims arising out of this Agreement or its breach, to non-binding mediation, within thirty (30) days after notice of a mediation request is given by one Party to the other Party.
- B. The Parties may agree on one mediator. If the Parties cannot agree on one mediator, the Party requesting mediation may request that the Superior Court, State of California, County of Santa Cruz appoint a mediator. The mediation meeting shall not exceed one day or eight (8) hours. The Parties may agree to extend the time allowed for mediation under this Agreement.
- C. The costs of such mediation shall be borne by the Parties equally.
- D. Mediation under this Section 43, if elected by District, is a condition precedent to filing an action in any court.
- E. This Section 43 shall survive termination of this Agreement.

44. ATTORNEY FEES

In the event any legal action or proceeding is commenced to interpret or enforce the terms of, or obligations arising out of this Agreement, or to recover damages for the breach thereof, the Party prevailing in any such action or proceeding shall be entitled to recover from the non-prevailing Party all reasonable attorneys' fees, costs and expenses incurred by the prevailing Party. This Section shall survive termination of this Agreement.

45. VENUE

The formation, interpretation and performance of this Agreement shall be governed by the laws of the State of California. Venue for all litigation relative to the formation, interpretation and performance of this Agreement shall be exclusively in the state courts of the State of California, County of Santa Cruz, or if jurisdiction is exclusively federal, in the United States District Court, Northern District of California, San Jose. This Section shall survive termination of this Agreement.

46. EXECUTION IN COUNTERPARTS

This Agreement may be executed in counterparts each of which shall be deemed an original but all of which shall constitute one and the same instrument.

San Lorenzo Valley Water District

Contract No. 22/23-16

47. **AUTHORITY**

The individuals executing this Agreement represent and warrant that they have the right, power, legal capacity and authority to enter into and to execute this Agreement on behalf of the respective legal entities of Consultant and District.

[Signatures on Following Page(s)]

San Lorenzo Valley Water District

Contract No. 22/23-16

IN WITNESS WHEREOF, the Parties hereto have executed this Agreement on the day first mentioned above, as evidenced by the signatures of their duly authorized representatives set forth below.

SAN LORENZO VALLEY WATER DISTRICT RAFTELIS FINANCIAL CONSULTANTS, INC.

Brian Frus
Interim General Manager
San Lorenzo Valley Water District

Authorized Signature

Printed Name

Title

ATTEST:

Company Name

Holly Hossack
District Secretary
San Lorenzo Valley Water District

Street Address

City, State, ZIP

APPROVED AS TO FORM:

Phone Number

Barbara Brenner
White Brenner, LLP

License Number(s) (if applicable)

Exhibit A

Project Scope of Services

The scope of required services for this project includes:

TASK 100 – PROJECT MANAGEMENT

Consultant shall propose a project schedule that meets or improves upon the timeline provided in this Request for Proposals.

Consultant shall provide overall project management, including contract administration and budget and schedule tracking.

Consultant shall provide internal quality control and quality assurance procedures.

Consultant shall assume about five meetings with staff, two public meetings (one each with the District Board and Budget & Finance Committee), and one public outreach workshop under the auspices of the District to gather community input.

TASK 200 – REVENUE REQUIREMENTS AND RATE SCHEDULE

Consultant will conduct a detailed review of the District's operating and capital improvement budgets and one-time costs associated with recovery from the CZU wildfire to determine revenue needs over 5-year and 10-year time horizons. Consultant will develop recommended alternatives for a 5-year rate schedule beginning with the fiscal year starting January 1, 2024 that promotes financial sustainability and maintains adequate debt coverage and reserve levels. In order to do so, the Consultant shall develop an understanding of the 2021 Water Master Plan and Capital Improvement Plan, the existing rate structure and the assumptions underlying cost distribution to the various cost centers, the District's reserve policies and other financial policies, and the District's existing debt-service requirements. In addition to studying relevant District reports and plans (links provided under XIII), the Consultant will familiarize themselves with the demographics of the District's ratepayers, and undertake field investigations sufficient to provide the appropriate background for making recommendations.

The rate study shall include the following:

- A detailed cost-of-service analysis.
- A determination of current and future revenue needed to provide water and wastewater services in conformance with current and anticipated changes to standards and regulations, and to undertake ongoing repair, maintenance, and upgrades of infrastructure.
- The development of a parameter-driven budgeting spreadsheet that incorporates the District's existing budgeting constructs and allows modeling for periods of up to 10 years, including but not limited to the following parameters:
 - Revenues under existing and modeled volumetric and connection rates
 - Growth in staffing expenses, including regular, overtime and incentive pay, benefits and pension obligations
 - Fixed and variable costs (e.g., utilities, chemicals, vehicles, software, consultants, Page A-1

San Lorenzo Valley Water District

Contract No. 22/23-16

outreach, travel), and includes a template for showing total operating margin, debt payments (interest and principal), and capital projects.

- An assessment of the existing customer service fee structure, identifying potential areas for new service and system charges, and recommendations regarding potential future charges.
- An exploration of various options for changes from the existing rate structure, including possible options in the list below, which may be altered or refined as the rate study develops based on discussions between District staff and the selected Consultant:
 - Tiered volumetric rates, including one model in which the lowest tier is tied to California's standard for per capita indoor water usage
 - Different rates for bulk water users (e.g., schools, mobile home parks)
 - Redistribution of revenue between service charges and volumetric charges to reflect the fixed nature of the majority of the District's operational costs, and to make annual revenue more predictable and less tied to consumption, which can be restricted in times of drought
 - Implementing a drought surcharge to replace the current system of revenue stabilization rates, in which the surcharge is placed into a restricted account that the District can access if consumption drops due to State mandates in response to drought conditions
 - Implementing a capital improvement surcharge the proceeds of which are placed into a restricted account the District can use only to pay for capital improvement projects
 - Establish cost-of-service for the District's 37 pressure zones that accounts for differences in pumping/utility costs for different pressure zones, and make a recommendation on whether it is practicable and/or equitable to set different rates for zones
- A demonstration that any recommendations on rate structure meet cash-flow objectives.
- Modeling how alternative rate structures would affect residential households as a function of use pattern (e.g., low-use, median use, high use) and economic status. Determine how the District can fund its low-income rate assistance program, given current state regulations, and provide recommendations on how it might be implemented under various rate structures.
- Recommendations for methods of communicating utility costs to ratepayers, assessing the ease of communication associated with each alternative rate structure, including how the layout of the utility bill might be used to identify actual costs of providing water and sewer services under different rate structures.

TASK 300 – FINAL RATE STUDY REPORT

Consultant shall prepare a draft report that provides a detailed analysis of work performed and assumptions made. The report shall provide a clear written analysis of the basis upon which revenue needs were calculated.

Consultant shall incorporate changes pursuant to comments received on the draft report on presentation to the District's Budget & Finance Committee and the Board of Directors. Consultant will present the final report and recommended rates to the Board of Directors and members of the public at a formal public hearing.

San Lorenzo Valley Water District
copies of the final report in both Adobe Acrobat (pdf) and Microsoft Word formats.

Contract No. 22/23-16

San Lorenzo Valley Water District

Contract No. 22/23-16

Exhibit B

Consultant Compensation

**Proposed Total Professional Fee and Fee
Schedule**

[See Following Page]

PROPOSED TOTAL PROFESSIONAL FEE AND FEE SCHEDULES

Proposed Total Professional Fee and Fee Schedules

The following table provides a breakdown of our proposed fee for this project. This table includes the estimated level of effort required for completing each task and the hourly billing rates for our project team members. Expenses include costs associated with travel and a \$10 per hour technology charge covering computers, networks, telephones, postage, etc.

Tasks	Web Meetings	In-person Meetings	Hours					Total Fees & Expenses
			SP	JW	NP	LR	Total	
1. Project Management	1	0	5	5	20	15	45	\$11,100
2. Revenue Requirements and Rate Schedule	4	0	30	15	60	80	185	\$44,825
3. Final Rate Study Report and Public Meetings	0	5	15	10	60	80	165	\$43,110
Total Meetings / Hours	5	5	50	30	140	175	395	
Hourly Billing Rate			\$350	\$285	\$250	\$165		
Total Professional Fees			\$17,500	\$8,550	\$35,000	\$28,875	\$89,925	
							Total Fees	\$89,925
							Total Expenses	\$9,110
							Total Fees & Expenses	\$99,035

SP - Sudhir Pardiwala, Project Director
 JW - John Wright, Technical Reviewer
 NP - Nancy Phan, Project Manager
 LR - Lindsay Roth, Staff Consultant



March 28, 2024

Mr. Brian Frus, PE
Interim General Manager
San Lorenzo Valley Water District
13060 Highway 9
Boulder Creek, CA 95006

Subject: Additional Funds Request

Dear Mr. Frus:

Raftelis is respectfully requesting an increase to the rate study budget of \$20,085. This is to help cover expenses related to additional work that has been done throughout the duration of the study, including the following:

- Four Board meetings instead of one
- Additional capital improvement program scenarios
- Wholesale pricing
- Responding to public records request
- Additional requested analyses
- Additional drafts of the report

This amount also includes estimated time for continued work on wholesale pricing and to develop wholesale/standby charges for Scotts Valley.

The additional work requested by the District in September was previously documented with Kendra Reed on October 13, 2023, before her departure. At that time, we noted that we would continue to track any additional out-of-scope work for this project.

An updated fee schedule is attached. If you need any other information to process this request, please let us know. We appreciate your attention to this matter and the opportunity for our firm to continue to provide assistance to the District on this important project.

Sincerely,

Handwritten signature of Theresa M. Jurotich in black ink.

Theresa Jurotich, P.E., PMP
Manager

P: 206.707.9155 / E: tjurotich@raftelis.com

Handwritten signature of Melissa E. Elliott in black ink.

Melissa Elliott
Executive Vice President

P: 303.305.1141 / E: melliott@raftelis.com

Tasks	Web Meetings - Staff	Web Meetings - Board/Committees	Hours					Total Fees & Expenses
			PD	TR	PM	SC	Total	
1. Project Management	1		5	5	20	15	45	\$11,100
2. Revenue Requirements and Rate Schedule	4	1	30	15	60	80	185	\$44,825
- additional financial plan scenarios & extra board meeting	5	3	4	1		20	25	\$5,235
- additional meetings/support/analysis	3		7	3	68	7	85	\$22,310
3. Final Rate Study Report and Public Meetings	3	4	8	6	60		74	\$20,250
Additional - Wholesale Intertie	1		7		20		27	\$7,720
Additional - School Bills					4		4	\$1,040
Additional Revisions to Presentations & Report	6		4		20		24	\$6,640
Total Meetings / Hours	23	8	65	30	252	122	469	
Hourly Billing Rate			\$350	\$285	\$250	\$165		
Total Professional Fees			\$22,750	\$8,550	\$63,000	\$20,130	\$114,430	
							Total Fees	\$114,430
							Total Expenses	\$4,690
							Total Fees & Expenses	\$119,120

PD - Project Director
 TR - Technical Reviewer
 PM - Project Manager
 SC - Staff Consultant
 Tech Charge = \$10/hr

MEMO

DATE: April 4, 2024
TO: Board of Directors, San Lorenzo Valley Water District
FROM: Brian Frus, Interim General Manager
SUBJECT: Contract Change Orders - 2021 CIP Pipeline Project

WRITTEN BY: Garrett Roffe, Engineering Manager

PRESENTED BY: Garrett Roffe, Engineering Manager

STAFF RECOMMENDATION

It is recommended that the Board of Directors directs the Interim General Manager to execute Contract Change Orders 17, 18, 19, and 20 for payment to JMB Construction Inc. as part of the District's 2021 CIP Pipeline (2021 CIP) project.

RECOMMENDED MOTION

The Board Directs the Interim General Manager to execute:

- 1) Contract Change Orders 17, 18, 19, and 20 for payment to JMB Construction Inc. for the 2021 CIP Pipeline project in the sum of \$68,628, increasing the not-to-exceed contract amount from \$5,143,143 to \$5,211,771, and
- 2) Authorizes the Interim General Manager to execute non-substantive modifications, as necessary.

BACKGROUND

On August 18, 2022, the Board awarded the 2021 CIP Pipeline Project to JMB Construction, Inc. for the bid in the amount of \$5,023,380 which included a ten percent contingency. The project replaces approximately 8,500 linear feet of water pipeline spread across four locations in the District; Juanita Woods; Orman Road; Hermosa Avenue; and Zayante Drive. The new pipelines are installed along both privately owned right-of-way (ROW) and publicly maintained ROW (maintained by the County of Santa Cruz) in addition to a small portion of the pipeline requiring installation within Caltrans ROW (State Highway 9).

The project also replaces an aging 40,000-gallon redwood tank with a new 160,000-gallon tank fitted with level monitoring instrumentation that will tie into the District's SCADA system.

CCO 17 - Hermosa Avenue Hydrant Reconnections

Project plans show three existing fire hydrants to be connected to new water laterals from the new main. The Contractor excavated the existing fire hydrants to make the connections and discovered the poor condition of existing hydrant components designated to remain per plan. District staff directed the Contractor to replace corroded components and reinstall the existing fire hydrants at three locations on the Hermosa Avenue site. The additional work to replace corroded components of the existing fire hydrants was tracked in a Daily Extra Work Report for payment adjustment at an agreed sum of \$22,905.

CCO 18 - Service Adjustments

Project plans show the new service laterals to connect at the existing meter location. Following the paving walk, several of the existing meter locations were determined to be in paved areas subject to traffic loading. District staff directed the Contractor to relocate the meter locations off the roadway. The additional work was tracked on Daily Extra Work Reports for a payment adjustment at the agreed sum of \$10,175.

CCO 19 - Valve Abandonment

During the process of abandoning the District's old pipelines, the existing water valves could not be fully closed and were leaking water. The Contractor submitted a request for information for direction on additional measures to ensure the abandoned pipelines were no longer continuously receiving water. The Contractor was directed to excavate all valves in question, cap the existing valve at main tie-in locations, and remove all surrounding valve infrastructure. The additional work was tracked on Daily Extra Work Reports resulting in a payment adjustment at an agreed sum of \$26,148.

CCO 20 - Juanita Woods CA-9 Main Connections

Project plans show the connection of the new water main for Juanita Woods Road and Brookside Drive at State Highway 9 with tee fittings. District staff directed the Contractor to install hot tap connections at these locations to benefit operational considerations. The additional work was tracked on a Daily Extra Work Report for a payment adjustment at the agreed sum of \$9,400.

ENVIRONMENTAL REQUIREMENTS

Pursuant to Title 14, the California Code of Regulations, Section 15302(c) of the California Environmental Quality Act (“CEQA”) guidelines, the proposed action is an administrative activity of the District that will not result in direct or indirect physical changes to the environment.

PRIOR COMMITTEE ACTION

None

FISCAL IMPACT

Summary Table	
Original Contract	\$4,566,709
Contingency	\$456,671
Sub Total – Contract with Contingency	\$5,023,380
Approved Change Orders to Date	\$576,434
New Change Orders	\$68,628
Total Contract with Change Orders	\$5,211,771
Amount over Contract	\$645,062
Percent Difference	14%

The total cost of the new change orders to JMB Construction, Inc. is \$68,628 which brings the total contract change orders to \$645,062. There are sufficient funds in the 2021 CIP Budget to cover these new expenses.

ATTACHMENTS

1. 2021 CIP Contract Change Order 17
2. 2021 CIP Contract Change Order 18
3. 2021 CIP Contract Change Order 19
4. 2021 CIP Contract Change Order 20



2021 CIP Pipeline Project – Contract Change Order

March 13th, 2024
Change Order No. 17
Contract No. 22/23-3

To: JMB Construction, Inc.

This Change Order No. 17 for the San Lorenzo Valley Water District’s 2021 CIP Pipeline Project encompasses the following changes to Contract No. 22/23-3:

1. Additional work to construct three hydrant reconnections on Hermosa Avenue as directed by District staff in the field and indicated in JMB Construction Inc. Letter # 938.100.20.190.30.10 COR #19 – Hermosa Avenue Hydrant Reconnections.
2. Extension of Contract Time of one (1) calendar day, the project is now to be completed by 7/2/24.

Payment Adjustment at Agreed Lump Sum of \$22,905.07; Adjusted Contract Price is \$5,166,048.24

By signing this change order all parties agree to the preceding changes to the plans, specifications, and contract documents.

Brian Frus, Interim General Manager
San Lorenzo Valley Water District

Date: _____

Adrian Power, Project Manager
JMB Construction, Inc

Date: _____

Mike Kuykendall, P.E.
Engineer of Record, Sandis Civil Engineers

Date: _____



November 10th, 2023

JMB LTR #: 938.100.20.190.30.10

To: San Lorenzo Valley Water District,
136060 CA-9,
Boulder Creek, CA 95006.

Attention: Garrett Roffe & Cameron Slach

Project/Contract: 2021 – CIP Pipeline Project

Subject: **COR # 19 – Hermosa Avenue Hydrant Reconnections**

Garrett/Cameron,

This letter is to serve as a Change Order Request from JMB Construction, Inc. for the additional costs associated with the 3 No. Hydrant Reconnections on Hermosa Avenue.

JMB Construction, Inc. has attached the Daily Extra Work Report Sheet(s) (See Attached in Appendix A) for the above additional costs. The following breakdown has been prepared based on the attached reports;

San Lorenzo Valley Water District – 2021 CIP Pipeline Project – COR # 19 Hermosa Avenue Hydrant Reconnections

Item	Description	Unit	Quantity	Unit Price	Extension
1	Hydrant Reconnections - T&M Tag (10/18/2023)	LS	1	\$ 22,905.07	\$ 22,905.07
Total Cost					\$ 22,905.07

**Requested Project Extension (Construction Activities) – 1.00 Day(s)*

Please do not hesitate to contact me at (650) 455-8985, if you should have any questions

Adrian Power

JMB Construction, Inc.

Project Manager

APPENDIX A

DAILY EXTRA WORK REPORT

Agenda: 4.4.24
Item: 10a

PROJECT TITLE: CIP Pipeline Project
 JOB NO: 938
 LOCATION: Hermosa Avenue (Various See Description)

REPORT NO: 938.100.20.190.10
 DATE PERFORMED: 10/18/2023
 DATE OF REPORT: 10/31/2023

DESCRIPTION OF WORK: During the installation of the 3 No. Fire Hydrant Reconnections @ the Hermosa Avenue location, crew discovered all 3 hydrants to be in poor condition (crew were decided to replace the corroded components and re-install the old hydrant. The 3 No. Hydrant Reconnection requiring additional materials/Installation were: STA 500+46 (Fernwood), STA 600+29 (Hermosa) and STA 604+35 (Hermosa/Dak).

LABOR			
EMPLOYEE NAME	CLASSIFICATION	REG HOURS	OT HOURS
Jose Robles	F	7.5	
Ricardo Cimacho	O	7.5	
Alonso Amador	L	7.5	
Diego Quinto Peniagua	L	7.5	
Jose Luis Aramburo	L	7.5	
Antonio Eleazar Perez	L	7.5	
Antonio Ramos	L	7.5	

EQUIPMENT - Manufacturer, Model, Capacity, Attachments, Weights, Axles, etc.	HOURS
- Crew Truck (Ford F250)	7.5
- 2 No. Skidsteer Loaders CAT 248's	7.5
- Loader L1106	7.5
- 2 No. Excavators (ECR 88 and ECR 58)	7.5
- JMB Pipe Truck and Chevy Site Truck	7.5
- Multiquip plate compactor and Vibraplate	7.5
- Tempstar Sweeper	7.5
- 10-Wheeler and 2 No. Bobtails	7.5

MATERIALS, RENTAL EQUIPMENT, SUBCONTRACTORS & WORK BY SPECIAL FORCES	NO. UNIT
- Piping Materials (Bury, Breakoff, Megalugs, Bolt Sets + Gaskets)	↓
- Slurry (6 Cu. Yards)	
	Calculate @ End w/ Invoices

[Signature]
 Submitted - Contractor's Representative

10/31/2023
 Date

Approved - Project Inspector

Date

CHANGE ORDER REQUEST/PROPOSAL REPORT

Agenda: 4.4.24
Item: 10a
REPORT NO. 938.100.20.190.10

PROJECT TITLE: SLVWD - 2021 CIP Pipeline Project

DAY: Wednesday

PROJECT NO: 938

DATE PERFORMED: 10/18/2023

LOCATION: Hermosa Avenue (Various See Description)

DATE OF REPORT: 10/31/2023

WORK PERFORMED BY: JMB Construction, Inc.

DESCRIPTION OF WORK: During the instalation of the 3 No. Fire Hydrant Reconnections at the Hermosa Avenue location, crew discovered all 3 existing hydrants to be in poor condition. Crew were directed to replace the corroded components and reinstall the old hydrant. The 3 No. Hydrant Reconnections requiring additional materials/installation were: STA 500+46 (Fernwood Ave.), STA 600+29 (Hermosa Ave.) & STA604+35 (Oak Ave.)

NO.	EQUIPMENT	HOURS/ DAY	HOURLY RATE	EXTENDED AMOUNTS	NO.	LABOR	HOURS	HOURLY RATE	EXTENDED AMOUNTS
1	Crew Truck (F250)	7.5	\$ 42.39	\$ 317.93	1	Jose Robles	O.T. 0	\$168.01	\$ -
2	Skidsteer Loaders (CAT 248's)	7.5	\$ 37.72	\$ 565.80			Reg. 7.5	\$121.89	\$ 914.18
1	Rubber Tire Loader Volvo L110G	7.5	\$ 139.07	\$ 1,043.03	1	Ricardo Camacho	O.T. 0	\$157.99	\$ -
1	Excavator Volvo ECR58	7.5	\$ 53.81	\$ 403.58			Reg. 7.5	\$116.88	\$ 876.60
1	Excavator Volvo ECR88	7.5	\$ 50.42	\$ 378.15	1	Alonso Amador	O.T. 0	\$104.07	\$ -
1	JMB Pipe Truck (2 Axle)	7.5	\$ 64.30	\$ 482.25			Reg. 7.5	\$79.26	\$ 594.45
1	JMB Site Truck (Chevrolet)	7.5	\$ 37.61	\$ 282.08	1	Pioquinto Paniagua	O.T. 0	\$112.06	\$ -
1	Multiquip Plate Compactor (MVH306D82)	7.5	\$ 5.25	\$ 39.38			Reg. 7.5	\$84.59	\$ 634.43
1	Multiquip Vibraplate (MVH306DS)	7.5	\$ 18.74	\$ 140.55	1	Jose Luis Aramburo	O.T. 0	\$104.07	\$ -
1	Laymor Sweeper	7.5	\$ 55.95	\$ 419.63			Reg. 7.5	\$79.26	\$ 594.45
1	10-Wheeler (3-Axle)	7.5	\$ 93.59	\$ 701.93	1	Antonio Eleazar Archilla	O.T. 0	\$108.07	\$ -
2	Bobtail (2-Axle)	7.5	\$ 73.34	\$ 1,100.10			Reg. 7.5	\$81.92	\$ 614.40
				\$ -	1	Antonio Ramos	O.T. 0	\$100.07	\$ -
				\$ -			Reg. 7.5	\$76.60	\$ 574.50
MATERIAL, RENTAL EQUIPMENT & WORK by SPECIAL FORCES							O.T.		\$ -
DESCRIPTION		NO.UNIT	UNIT COST				Reg.		\$ -
Hydrant Material (See Ferguson Invoice #1821799)		1	\$9,226.71	\$ 9,226.71	TOTAL COST OF LABOR A \$ 4,803.00 TOTAL COST OF EQUIP B \$ 5,874.38 TOTAL COST OF MATERIAL C \$ 10,145.42				
Slurry 6 YDS See GraniteRock Invoice #2122844		1	\$918.71	\$ 918.71					
				\$ -					
				\$ -	10% ON LABOR (A) \$ 480.30 10% EQUIP (B) \$ 587.44 10% ON MATERIAL (C) \$ 1,014.54				
				\$ -					
				\$ -					
TOTAL COST OF EQUIP, MATERIALS & WORK BY SPECIAL FORCES				\$ 16,019.80	TOTAL THIS REPORT \$ 22,905.07				

FERGUSON
WATERWORKS
27750 INDUSTRIAL BLVD
HAYWARD, CA 94545-3629

INVOICE NUMBER	TOTAL DUE	CUSTOMER	PAGE
1821799	\$9,226.71	454930	1 of 1

**PLEASE REFER TO INVOICE NUMBER WHEN
MAKING PAYMENT AND REMIT TO:**

FERGUSON WATERWORKS #1423
PO BOX 740827
LOS ANGELES, CA 90074-0827

Please contact with Questions: 510-786-3333

MASTER ACCOUNT NUMBER: 230316

SHIP TO:

JMB CONSTRUCTION INC
132 SOUTH MAPLE AVE
SLVWD - 2021 CIP PIPELINE
SOUTH SAN FRANCISCO, CA 94080-6320



JMB CONSTRUCTION INC
70 RIDGE DR
SLVWD - 2021 CIP PIPELINE PROJ
BOULDER CREEK, CA 95006

SHIP WHSE.	SELL WHSE.	TAX CODE	CUSTOMER ORDER NUMBER	SALESMAN	JOB NAME	INVOICE DATE	BATCH
3300	3300	CA44	BURYS	GEW	SLVWD - 2021 CIP PIPELINE	10/23/23	IO 90714
ORDERED	SHIPPED	ITEM NUMBER	DESCRIPTION	UNIT PRICE	UM	AMOUNT	
			QTY. 3 EACH HYD BOLT SETS SHIP PAYLOAD OR OTHER. JOSE 415.559.0340				
3	3	C636MJHBFBE	6X36 MJ HYD BURY EPOX IN & OUT	550.000	EA	1650.00	
3	3	CLB4006H	HYD BREAK OFF CHK VLV 6 HOLE	2100.000	EA	6300.00	
3	3	E1106DSC	6 MEGALUG ACC PKG W/ MJ GSKT F/ DI	70.000	EA	210.00	
25	3	T1LS656	6 SS 316 HYD N&B SET 6H	21.140	EA	63.42	
25	3	T1LB656	6 SS 316 6H HYD 5/8X3 B/O N&B SET	27.130	EA	81.39	
6	6	R150FFH18GU	6 150# RR 1/8 FF HYD GSKT	3.740	EA	22.44	
INVOICE SUB-TOTAL						8327.25	
DELIVERY						150.00	
TAX						749.46	Santa Cruz

LEAD LAW WARNING: IT IS ILLEGAL TO INSTALL PRODUCTS THAT ARE NOT "LEAD FREE" IN ACCORDANCE WITH US FEDERAL OR OTHER APPLICABLE LAW IN POTABLE WATER SYSTEMS ANTICIPATED FOR HUMAN CONSUMPTION. PRODUCTS WITH *NP IN THE DESCRIPTION ARE NOT LEAD FREE AND CAN ONLY BE INSTALLED IN NON-POTABLE APPLICATIONS. BUYER IS SOLELY RESPONSIBLE FOR PRODUCT SELECTION.

WATER FLOW RATE NOTICE: LAVATORY FAUCETS WITH FLOW RATES OVER 0.5 GPM ARE NOT ALLOWED FOR 'PUBLIC USE' IN CALIFORNIA.

Looking for a more convenient way to pay your bill?

Log in to **Ferguson.com** and request access to Online Bill Pay.



TERMS: NET 10TH PROX	ORIGINAL INVOICE	TOTAL DUE	\$9,226.71
-----------------------------	-------------------------	------------------	-------------------

All past due amounts are subject to a service charge of 1.5% per month, or the maximum allowed by law, if lower. If Buyer fails to pay within terms, then in addition to other remedies, Buyer agrees to pay Seller all costs of collection, including reasonable attorney fees. Complete terms and conditions are available upon request or at <https://www.ferguson.com/content/website-info/terms-of-sale>, incorporated by reference. Seller may convert checks to ACH.



P.O. Box 50001
Watsonville, CA 95077-5001
(831) 768-2000

Customer: 40067

JMB Construction*PO Req.**
132 South Maple Avenue
South San Francisco, CA 94080

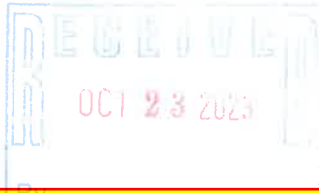

Invoice No: 2122844
Invoice Date: 10/21/2023
Job No:
Order No: 2110478
Job PO No: TBD
Job Name: SLVWD CIP Pipeline
Job Street: 205 Brookside Dr Boulder Creek
Job City: Boulder Creek

9 YDS of Slurry = \$ 1,378.07
6 YDS of Slurry = \$ 918.71

Concrete

Product	Qty	Product Price	Amount	Freight Price	Amount	Additional Charges	Tax Amount	Total	
Date: 10/16/2023 Ticket: 424888 Location: Santa Cruz Concrete									
002200SC	9.00	Cu Yd 130.00	1,170.00			45.00	9.00%	105.30	1,320.30
2.0 SK CDF / CLSM SC SAND									
000FSC	1.00	EA 18.00	18.00				9.00%	1.62	19.62
FUEL SURCHARGE- CONCRETE									
00ERFC	1.00	EA 35.00	35.00				9.00%	3.15	38.15
ENVIRONMENTAL RECOVERY FEE									
Totals for Ticket 424888			1,223.00	0.00	45.00	110.07		1,378.07	
Date: 10/16/2023 Ticket: 424889 Location: Santa Cruz Concrete									
002200SC	9.00	Cu Yd 130.00	1,170.00			45.00	9.00%	105.30	1,320.30
2.0 SK CDF / CLSM SC SAND									
000FSC	1.00	EA 18.00	18.00				9.00%	1.62	19.62
FUEL SURCHARGE- CONCRETE									
00ERFC	1.00	EA 35.00	35.00				9.00%	3.15	38.15
ENVIRONMENTAL RECOVERY FEE									
Totals for Ticket 424889			1,223.00	0.00	45.00	110.07		1,378.07	
Date: 10/16/2023 Ticket: 424890 Location: Santa Cruz Concrete									
002200SC	9.00	Cu Yd 130.00	1,170.00			45.00	9.00%	105.30	1,320.30
2.0 SK CDF / CLSM SC SAND									
000FSC	1.00	EA 18.00	18.00				9.00%	1.62	19.62
FUEL SURCHARGE- CONCRETE									
00ERFC	1.00	EA 35.00	35.00				9.00%	3.15	38.15
ENVIRONMENTAL RECOVERY FEE									
Totals for Ticket 424890			1,223.00	0.00	45.00	110.07		1,378.07	
Date: 10/19/2023 Ticket: 424996 Location: Santa Cruz Concrete									
002200SC	9.00	Cu Yd 130.00	1,170.00			45.00	9.00%	105.30	1,320.30
2.0 SK CDF / CLSM SC SAND									
000FSC	1.00	EA 18.00	18.00				9.00%	1.62	19.62
FUEL SURCHARGE- CONCRETE									
00ERFC	1.00	EA 35.00	35.00				9.00%	3.15	38.15
ENVIRONMENTAL RECOVERY FEE									
Totals for Ticket 424996			1,223.00	0.00	45.00	110.07		1,378.07	
Date: 10/19/2023 Ticket: 424997 Location: Santa Cruz Concrete									



2021 CIP Pipeline Project – Contract Change Order

March 13th, 2024
Change Order No. 18
Contract No. 22/23-3

To: JMB Construction, Inc.

This Change Order No. 18 for the San Lorenzo Valley Water District’s 2021 CIP Pipeline Project encompasses the following changes to Contract No. 22/23-3:

1. Additional work to adjust/move multiple water services off roadway as directed by District staff in the field and indicated in JMB Construction Inc. Letter # 938.100.20.210.60.10 COR #21 – Service Adjustments.
2. Extension of Contract Time of two (2) calendar days, the project is now to be completed by 7/4/24.

Payment Adjustment at Agreed Lump Sum of \$10,174.72; Adjusted Contract Price is \$5,176,222.96

By signing this change order all parties agree to the preceding changes to the plans, specifications, and contract documents.

Brian Frus, Interim General Manager
San Lorenzo Valley Water District

Date: _____

Adrian Power, Project Manager
JMB Construction, Inc

Date: _____

Mike Kuykendall, P.E.
Engineer of Record, Sandis Civil Engineers

Date: _____



December 12th, 2023

JMB LTR #: 938.100.20.210.60.10

To: San Lorenzo Valley Water District,
136060 CA-9,
Boulder Creek, CA 95006.

Attention: Garrett Roffe & Cameron Slach

Project/Contract: 2021 – CIP Pipeline Project

Subject: **COR # 21 – Service Adjustments**

Garrett/Cameron,

This letter is to serve as a Change Order Request from JMB Construction, Inc. for the additional costs associated with adjusting/moving multiple water services on the above referenced project.

JMB Construction, Inc. has attached the Daily Extra Work Report Sheet(s) (See Attached in Appendix A) for the above additional costs. The following breakdown has been prepared based on the attached reports;

San Lorenzo Valley Water District – 2021 CIP Pipeline Project – COR # 21 Service Adjustments

Item	Description	Unit	Quantity	Unit Price	Extension
1	110 Juanita Road - T&M Tag (11/02/2023)	LS	1	\$ 2,897.18	\$ 2,897.18
2	290 Igo Way - T&M Tag (11/07/2023)	LS	1	\$ 2,502.59	\$ 2,502.59
3	9774 Zayante Drive - T&M Tag (11/22/2023)	LS	1	\$ 2,517.50	\$ 2,517.50
4	Orman Road (FS) - T&M Tag (11/28/2023)	LS	1	\$ 2,257.45	\$ 2,257.45
Total Cost					\$ 10,174.72

**Requested Project Extension (Construction Activities) – 2.00 Day(s)*

Please do not hesitate to contact me at (650) 455-8985, if you should have any questions

Adrian Power

JMB Construction, Inc.

Project Manager

APPENDIX A

DAILY EXTRA WORK REPORT

Agenda 4.4.24
Item: 10a

PROJECT TITLE: CIP Pipeline Project
 JOB NO: 938
 LOCATION: 110 Juanita Road

REPORT NO: 938.100.20.210.10
 DATE PERFORMED: 11/02/2023
 DATE OF REPORT: 11/06/2023

DESCRIPTION OF WORK: Additional costs associated with moving the water meter @ 110 Juanita Road off the roadway and onto 110's private property. Crew excavated to the main, installed a longer service run and relocated the property Owner's meter.

LABOR			
EMPLOYEE NAME	CLASSIFICATION	REG HOURS	OT HOURS
<u>José Robles</u>	<u>F</u>	<u>4</u>	
<u>Ricardo Camacho</u>	<u>O</u>	<u>4</u>	
<u>Alonso Amador</u>	<u>L</u>	<u>4</u>	
<u>Pioquinto Prunigua</u>	<u>L</u>	<u>4</u>	
<u>Antonio Ramos</u>	<u>L</u>	<u>4</u>	

EQUIPMENT - Manufacturer, Model, Capacity, Attachments, Weights, Axles, etc.	HOURS
<u>- Crew Truck (Ford F250)</u>	<u>4</u>
<u>- ECR88 Excavator</u>	<u>4</u>
<u>- Bobtail</u>	<u>4</u>

MATERIALS, RENTAL EQUIPMENT, SUBCONTRACTORS & WORK BY SPECIAL FORCES	NÓ. UNIT
<u>- Water Service Material (1" nose, Water Service Material + Meter Material)</u>	<div style="text-align: center;">↓</div>
<u>* Some Materials purchased previously and used here *</u>	
<u>- Slurry (Demo Material offhaul)</u>	
<u>- CLTAS Buckfill (2 Tons - purchased previously)</u>	
	<u>Calculate @ End w/ Invoices.</u>

[Signature]
 Submitted - Contractor's Representative

11/06/2023
 Date

Approved - Project Inspector

Date

CHANGE ORDER REQUEST/PROPOSAL REPORT

Agenda: 4.4.24
 REPORT NO: 938.100.20.210.10
 Item: 10a

PROJECT TITLE: SLVWD - 2021 CIP Pipeline Project

DAY: Thursday

PROJECT NO: 938

DATE PERFORMED: 11/2/2023

LOCATION: 110 Juanita Road

DATE OF REPORT: 11/6/2023

WORK PERFORMED BY: JMB Construction, Inc.

DESCRIPTION OF WORK: Additional costs associated with moving the water meter @ 110 Juanita Road off the roadway and onto 110's Private Property. Crew excavated to the main and installed a longer service run and relocated the property owners meter.

NO.	EQUIPMENT	HOURS/ DAY	HOURLY RATE	EXTENDED AMOUNTS	NO.	LABOR	HOURS	HOURLY RATE	EXTENDED AMOUNTS	
1	Crew Truck (F250)	4	\$ 42.39	\$ 169.56	1	Jose Robles	O.T.	0	\$168.01	\$ -
1	Excavator Volvo ECR88	4	\$ 50.42	\$ 201.68			Reg.	4	\$121.89	\$ 487.56
1	Bobtail (2-Axle)	4	\$ 73.34	\$ 293.36	1	Ricardo Camacho	O.T.	0	\$157.99	\$ -
				\$ -			Reg.	4	\$116.88	\$ 467.52
				\$ -	1	Alonso Amador	O.T.	0	\$104.07	\$ -
				\$ -			Reg.	4	\$79.26	\$ 317.04
				\$ -	1	Pioquinto Paniagua	O.T.	0	\$112.06	\$ -
				\$ -			Reg.	4	\$84.59	\$ 338.36
				\$ -	1	Antonio Ramos	O.T.	0	\$100.07	\$ -
				\$ -			Reg.	4	\$76.60	\$ 306.40
				\$ -			O.T.			\$ -
				\$ -			Reg.			\$ -
				\$ -			O.T.			\$ -
				\$ -			Reg.			\$ -
MATERIAL, RENTAL EQUIPMENT & WORK by SPECIAL FORCES							O.T.			\$ -
DESCRIPTION		NO.UNIT	UNIT COST				Reg.			\$ -
Water Service Material - No Charge		1	\$0.00	\$ -	TOTAL COST OF LABOR A \$ 1,916.88 TOTAL COST OF EQUIP B \$ 664.60 TOTAL COST OF MATERIAL C \$ 52.32					
Slurry (Demo Material Offhaul) - No Charge		1	\$0.00	\$ -						
CLIIAB (See Granite Invoice #2603812)		2	\$26.16	\$ 52.32						
				\$ -						
				\$ -	10% ON LABOR (A) \$ 191.69 10% EQUIP (B) \$ 66.46 10% ON MATERIAL (C) \$ 5.23					
				\$ -						
				\$ -						
TOTAL COST OF EQUIP, MATERIALS & WORK BY SPECIAL FORCES				\$ 716.92	TOTAL THIS REPORT \$ 2,897.18					

INVOICE



PLEASE MAIL REMITTANCE TO:

Granite Construction Company
PO Box 742478
Los Angeles, CA 90074-2478

INVOICE DATE: 11/1/2023

Bill To:

JMB CONSTRUCTION INC
132 SOUTH MAPLE AVENUE
SOUTH SAN FRANCISCO CA 94080-6302
MGOAN@JMBCONSTRUCTION.COM

ORDER NO.	CUSTOMER NO.	PLANT	INVOICE NO.
295439	294825	FELTON A.C PLANT 201815 100321	2603812
ORIGINAL INVOICE #		JOB ADDRESS	DATE OF SALE
		SLVWD -CIP PIPELINE -BEN LOMOND 9500 BROOKSIDE AVENUE BEN LOMOND CA 95005	11/1/2023
			PO #
			938

A LATE FEE OF 1.5% PER MONTH (18% PER ANNUM) WILL BE APPLIED ON PAST DUE BALANCES

A CREDIT CARD FEE OF 2.3% WILL BE APPLIED TO ALL CREDIT CARD PAYMENTS MADE MORE THAN 10 BUSINESS DAYS AFTER THE INVOICE DATE ABOVE

TICKET NUMBER	TICKET DATE	MATERIAL DESCRIPTION	QTY	UNIT PRICE	EXTENDED AMOUNT	FOB	TAX RATE AREA
44582002	11/1/2023	1056 - 1/2"HMA64-10R15	2.000 TN	98.000	\$196.00	P	V050870000
		TOTAL: 1056 - 1/2"HMA64-10R15	2.0000 TN		\$196.00		
31630444	11/1/2023	2942 - COMMERCIAL BASE	12.500 TN	12.000	\$150.00	P	V050870000
		TOTAL: 2942 - COMMERCIAL BASE	12.5000 TN		\$150.00		

2 Tons of CLIAB
2 * \$12.00 + Tax = \$26.16

TERMS: A/R Net 30 Days

The prevailing party shall be entitled to reasonable attorney's fees and costs in any action to collect the amounts due hereunder.
Note: If haul charges are indicated separately above, then the title passage of materials is at the plant, with delivery provided for customers.
The environmental fee is not a tax, surcharge, or fee mandated by or remitted to any governmental or regulatory agency but used to recover direct and indirect costs for Granite and its subsidiaries operations to be conducted in an environmentally sustainable manner.
For any question regarding this billing, please call (831)768-4002.

TOTAL FREIGHT	.00
MATERIAL	346.00
FEES	.00
SALES TAX	31.14

FOB: P=PLANT J=JOB

FOR OFFICIAL USE ONLY

Thank You for your business.

INVOICE TOTAL

\$377.14

WARNING: THIS PRODUCT CONTAINS A CHEMICAL KNOWN TO THE STATE OF CALIFORNIA TO CAUSE CANCER, BIRTH DEFECTS OR OTHER REPRODUCTIVE HARM. MSDS SHEETS AVAILABLE AT WWW.GRANITECONSTRUCTION.COM/MSDS OR BY CONTACTING YOUR LOCAL OFFICE.

DAILY EXTRA WORK REPORT

Agenda 4.4.24
Item 10a

PROJECT TITLE: CIP Pipeline Project
 JOB NO: 938
 LOCATION: 290 160 Way

REPORT NO: 938.100.20.210.20
 DATE PERFORMED: 11/07/2023
 DATE OF REPORT: 11/10/2023

DESCRIPTION OF WORK: Additional costs associated with the water meter @ 290 160 Way off the roadway and onto 290's private property. Crew excavated at the meter and moved back a min of 6" from edge of roadway edge per the response to RFI #11.

LABOR			
EMPLOYEE NAME	CLASSIFICATION	REG HOURS	OT HOURS
<u>José Robles</u>	<u>F</u>	<u>4</u>	
<u>Ricardo Camacho</u>	<u>O</u>	<u>4</u>	
<u>Alonso Amador</u>	<u>L</u>	<u>4</u>	
<u>Pedrinho Dominguez</u>	<u>L</u>	<u>4</u>	

EQUIPMENT - Manufacturer, Model, Capacity, Attachments, Weights, Axles, etc.	HOURS
<u>- Crew Truck (Ford F250)</u>	<u>4</u>
<u>- ECR 88 Excavator</u>	<u>4</u>
<u>- Bobtail</u>	<u>4</u>

MATERIALS, RENTAL EQUIPMENT, SUBCONTRACTORS & WORK BY SPECIAL FORCES	NO. UNIT
<u>- Misc. Fittings for Moving Meter.</u>	↓
	↓
	<u>Calculate @ End w/ Invoices.</u>

[Signature]
 Submitted - Contractor's Representative

11/10/2023
 Date

Approved - Project Inspector

Date

CHANGE ORDER REQUEST/PROPOSAL REPORT

Agenda: 4.4.24
 REPORT NO: 938.100.20.210.20

PROJECT TITLE: SLVWD - 2021 CIP Pipeline Project

PROJECT NO: 938

LOCATION: 290 Igo Way

WORK PERFORMED BY: JMB Construction, Inc.

DESCRIPTION OF WORK: Additional costs associated with moving the water meter @ 290 Juanita Road off the roadway and onto 290's Private Property. Crew excavated at the meter and moved back a min of 6" from the edge of the roadway per the response to RFI #11.

DAY: Tuesday

DATE PERFORMED: 11/7/2023

DATE OF REPORT: 11/10/2023

NO.	EQUIPMENT	HOURS/ DAY	HOURLY RATE	EXTENDED AMOUNTS	NO.	LABOR	HOURS	HOURLY RATE	EXTENDED AMOUNTS	
1	Crew Truck (F250)	4	\$ 42.39	\$ 169.56	1	Jose Robles	O.T.	0	\$168.01	\$ -
1	Excavator Volvo ECR88	4	\$ 50.42	\$ 201.68			Reg.	4	\$121.89	\$ 487.56
1	Bobtail (2-Axle)	4	\$ 73.34	\$ 293.36	1	Ricardo Camacho	O.T.	0	\$157.99	\$ -
				\$ -			Reg.	4	\$116.88	\$ 467.52
				\$ -	1	Alonso Amador	O.T.	0	\$104.07	\$ -
				\$ -			Reg.	4	\$79.26	\$ 317.04
				\$ -	1	Pioquinto Paniagua	O.T.	0	\$112.06	\$ -
				\$ -			Reg.	4	\$84.59	\$ 338.36
				\$ -			O.T.			\$ -
				\$ -			Reg.			\$ -
				\$ -			O.T.			\$ -
				\$ -			Reg.			\$ -
				\$ -			O.T.			\$ -
				\$ -			Reg.			\$ -
				\$ -			O.T.			\$ -
				\$ -			Reg.			\$ -
MATERIAL, RENTAL EQUIPMENT & WORK by SPECIAL FORCES							O.T.			\$ -
DESCRIPTION		NO.UNIT	UNIT COST				Reg.			\$ -
Water Service Material - No Charge		1	\$0.00	\$ -	TOTAL COST OF LABOR A \$ 1,610.48 TOTAL COST OF EQUIP B \$ 664.60 TOTAL COST OF MATERIAL C \$ - 10% ON LABOR (A) \$ 161.05 10% EQUIP (B) \$ 66.46 10% ON MATERIAL (C) \$ - TOTAL THIS REPORT \$ 2,502.59					
				\$ -						
				\$ -						
				\$ -						
				\$ -						
				\$ -						
TOTAL COST OF EQUIP, MATERIALS & WORK BY SPECIAL FORCES				\$ 664.60						

DAILY EXTRA WORK REPORT

Agenda: 4.4.24
~~Wetmore/10a~~

PROJECT TITLE: CIP Pipeline Project
 JOB NO: 938
 LOCATION: 9774 Zapante Drive

REPORT NO: 938.100.20710.30
 DATE PERFORMED: 11/22/2023
 DATE OF REPORT: 11/27/2023

DESCRIPTION OF WORK: Additional costs associated with adjusting the water Meter @ 9774 Zapante Drive from off the roadway and onto the residents private property. Crew excavated at the meter and moved back a min. of 6" from edge of Roadway.

LABOR			
EMPLOYEE NAME	CLASSIFICATION	REG HOURS	OT HOURS
<u>Jose Robles</u>	<u>F</u>	<u>4</u>	
<u>Ricardo Camacho</u>	<u>O</u>	<u>4</u>	
<u>Alonso Amador</u>	<u>L</u>	<u>4</u>	
<u>Pedro Jimenez</u>	<u>L</u>	<u>4</u>	

EQUIPMENT - Manufacturer, Model, Capacity, Attachments, Weights, Axles, etc.	HOURS
<u>-Crew Truck (Ford F250)</u>	<u>4</u>
<u>-ECR 58 Excavator</u>	<u>4</u>
<u>-Bobtail</u>	<u>4</u>

MATERIALS, RENTAL EQUIPMENT, SUBCONTRACTORS & WORK BY SPECIAL FORCES	NO. UNIT
<u>-Misc. Fittings for Moving Meter</u>	↓
	<u>Calculate @ End</u>
	<u>w/ Invoices</u>

[Signature]
 Submitted - Contractor's Representative

11/27/2023
 Date

Approved - Project Inspector

Date

CHANGE ORDER REQUEST/PROPOSAL REPORT

Agenda: 4.4.24
 REPORT NO: 938.100.20.210.30

PROJECT TITLE: SLVWD - 2021 CIP Pipeline Project

DAY: Wednesday

PROJECT NO: 938

DATE PERFORMED: 11/22/2023

LOCATION: 9774 Zayante Drive

DATE OF REPORT: 11/27/2023

WORK PERFORMED BY: JMB Construction, Inc.

DESCRIPTION OF WORK: Additional costs associated with moving the water meter @ 9774 Zayante Drive from off the roadway and onto the residents private property.
 Crew excavated at the meter and moved back a min of 6" from the edge of the roadway.

NO.	EQUIPMENT	HOURS/ DAY	HOURLY RATE	EXTENDED AMOUNTS	NO.	LABOR	HOURS	HOURLY RATE	EXTENDED AMOUNTS	
1	Crew Truck (F250)	4	\$ 42.39	\$ 169.56	1	Jose Robles	O.T.	0	\$168.01	\$ -
1	Excavator Volvo ECR58	4	\$ 53.81	\$ 215.24			Reg.	4	\$121.89	\$ 487.56
1	Bobtail (2-Axle)	4	\$ 73.34	\$ 293.36	1	Ricardo Camacho	O.T.	0	\$157.99	\$ -
				\$ -			Reg.	4	\$116.88	\$ 467.52
				\$ -	1	Alonso Amador	O.T.	0	\$104.07	\$ -
				\$ -			Reg.	4	\$79.26	\$ 317.04
				\$ -	1	Pioquinto Paniagua	O.T.	0	\$112.06	\$ -
				\$ -			Reg.	4	\$84.59	\$ 338.36
				\$ -			O.T.			\$ -
				\$ -			Reg.			\$ -
				\$ -			O.T.			\$ -
				\$ -			Reg.			\$ -
				\$ -			O.T.			\$ -
				\$ -			Reg.			\$ -
				\$ -			O.T.			\$ -
				\$ -			Reg.			\$ -
MATERIAL, RENTAL EQUIPMENT & WORK by SPECIAL FORCES							O.T.			\$ -
DESCRIPTION		NO.UNIT	UNIT COST				Reg.			\$ -
Water Service Material - No Charge		1	\$0.00	\$ -	TOTAL COST OF LABOR A \$ 1,610.48 TOTAL COST OF EQUIP B \$ 678.16 TOTAL COST OF MATERIAL C \$ - 10% ON LABOR (A) \$ 161.05 10% EQUIP (B) \$ 67.82 10% ON MATERIAL (C) \$ - TOTAL THIS REPORT \$ 2,517.50					
				\$ -						
				\$ -						
				\$ -						
				\$ -						
				\$ -						
TOTAL COST OF EQUIP, MATERIALS & WORK BY SPECIAL FORCES				\$ 678.16						

DAILY EXTRA WORK REPORT

Agenda: 4.4.24
~~Tuesday~~
Item: 10a

PROJECT TITLE: CIP Pipeline Project
 JOB NO: 938
 LOCATION: Oerman Road (Future use Service)

REPORT NO: 938.100.20.210.40
 DATE PERFORMED: 11/28/2023
 DATE OF REPORT: 11/29/2023

DESCRIPTION OF WORK: Additional costs associated with adjusting the Future use meter at the bottom of Oerman Road per SLWD direction. Crew removed the meter box, adjusted the meter and buried ~ 80LF of 1" HOPE Hose.

LABOR			
EMPLOYEE NAME	CLASSIFICATION	REG HOURS	OT HOURS
<u>Jose Robles</u>	<u>F</u>	<u>3</u>	
<u>Ricardo Jimacho</u>	<u>O</u>	<u>3</u>	
<u>Alonso Amador</u>	<u>L</u>	<u>3</u>	
<u>Jose Luis Aramburo</u>	<u>L</u>	<u>3</u>	
<u>Antonio Ramos</u>	<u>L</u>	<u>3</u>	
<u>Antonio Eleazar Perez</u>	<u>L</u>	<u>3</u>	

EQUIPMENT - Manufacturer, Model, Capacity, Attachments, Weights, Axles, etc.	HOURS
<u>- Crew Truck (Ford F250)</u>	<u>3</u>
<u>- ECR58 Excavator</u>	<u>3</u>

MATERIALS, RENTAL EQUIPMENT, SUBCONTRACTORS & WORK BY SPECIAL FORCES	NO. UNIT
<u>- None</u>	

[Signature]
 Submitted - Contractor's Representative

11/29/2023
 Date

Approved - Project Inspector

Date

CHANGE ORDER REQUEST/PROPOSAL REPORT

Agenda: 4.4.24
 Item: 10a
 REPORT NO: 938.100.20.210.40

PROJECT TITLE: SLVWD - 2021 CIP Pipeline Project

DAY: Tuesday

PROJECT NO: 938

DATE PERFORMED: 11/28/2023

LOCATION: Orman Road (Future Use Service)

DATE OF REPORT: 11/29/2023

WORK PERFORMED BY: JMB Construction, Inc.

DESCRIPTION OF WORK: Additional costs associated with adjusting the future use meter and exposed service run at the bottom of Orman Road per SLVWD direction.
 Crew removed the meter box, adjusted the meter and buried ~80LF of exposed 1" HDPE Hose.

NO.	EQUIPMENT	HOURS/ DAY	HOURLY RATE	EXTENDED AMOUNTS	NO.	LABOR	HOURS	HOURLY RATE	EXTENDED AMOUNTS
1	Crew Truck (F250)	4	\$ 42.39	\$ 169.56	1	Jose Robles	O.T. 0	\$168.01	\$ -
1	Excavator Volvo ECR58	4	\$ 53.81	\$ 215.24			Reg. 3	\$121.89	\$ 365.67
				\$ -	1	Ricardo Camacho	O.T. 0	\$157.99	\$ -
				\$ -			Reg. 3	\$116.88	\$ 350.64
				\$ -	1	Alonso Amador	O.T. 0	\$104.07	\$ -
				\$ -			Reg. 3	\$79.26	\$ 237.78
				\$ -	1	Jose Luis Aramburo	O.T. 0	\$104.07	\$ -
				\$ -			Reg. 3	\$79.26	\$ 237.78
				\$ -	1	Antonio Ramos	O.T. 0	\$100.07	\$ -
				\$ -			Reg. 3	\$76.60	\$ 229.80
				\$ -	1	Antonio Eleazar Archilla	O.T. 0	\$108.07	\$ -
				\$ -			Reg. 3	\$81.92	\$ 245.76
				\$ -			O.T.		\$ -
				\$ -			Reg.		\$ -
MATERIAL, RENTAL EQUIPMENT & WORK by SPECIAL FORCES							O.T.		\$ -
DESCRIPTION		NO.UNIT	UNIT COST				Reg.		\$ -
				\$ -	TOTAL COST OF LABOR A \$ 1,667.43 TOTAL COST OF EQUIP B \$ 384.80 TOTAL COST OF MATERIAL C \$ - 10% ON LABOR (A) \$ 166.74 10% EQUIP (B) \$ 38.48 10% ON MATERIAL (C) \$ - TOTAL THIS REPORT \$ 2,257.45				
				\$ -					
				\$ -					
				\$ -					
				\$ -					
				\$ -					
				\$ -					
TOTAL COST OF EQUIP, MATERIALS & WORK BY SPECIAL FORCES				\$ 384.80					



2021 CIP Pipeline Project – Contract Change Order

March 13th, 2024
Change Order No. 19
Contract No. 22/23-3

To: JMB Construction, Inc.

This Change Order No. 19 for the San Lorenzo Valley Water District’s 2021 CIP Pipeline Project encompasses the following changes to Contract No. 22/23-3:

1. Additional work to abandon the existing leaking valves at Brookside/Juanita, Hermosa/Fernwood and Zayante Drive per the response of RFI #13 and indicated in JMB Construction Inc. Letter # 938.100.20.230.60.10 COR #23 – Valve Abandonment.
2. Extension of Contract Time of three (3) calendar days, the project is now to be completed by 7/4/24.

Payment Adjustment at Agreed Lump Sum of \$26,147.76; Adjusted Contract Price is \$5,202,370.72

By signing this change order all parties agree to the preceding changes to the plans, specifications, and contract documents.

Brian Frus, Interim General Manager
San Lorenzo Valley Water District

Date: _____

Adrian Power, Project Manager
JMB Construction, Inc

Date: _____

Mike Kuykendall, P.E.
Engineer of Record, Sandis Civil Engineers

Date: _____



December 15th, 2023

JMB LTR #: 938.100.20.230.60.10

To: San Lorenzo Valley Water District,
136060 CA-9,
Boulder Creek, CA 95006.

Attention: Garrett Roffe & Cameron Slach

Project/Contract: 2021 – CIP Pipeline Project

Subject: **COR # 23 – Valve Abandonment**

Garrett/Cameron,

This letter is to serve as a Change Order Request from JMB Construction, Inc. for the additional costs associated with abandoning the existing leaking valves on the above referenced project per the response to RFI #13.

JMB Construction, Inc. has attached the Daily Extra Work Report Sheet(s) (See Attached in Appendix A) for the above additional costs. The following breakdown has been prepared based on the attached reports;

San Lorenzo Valley Water District – 2021 CIP Pipeline Project – COR # 21 Service Adjustments

Item	Description	Unit	Quantity	Unit Price	Extension
1	CA-9 Brookside/Juanita - T&M Tag (11/09/2023)	LS	1	\$ 7,647.76	\$ 7,647.76
2	CA-9 Brookside/Juanita - T&M Tag (11/10/2023)	LS	1	\$ 2,572.11	\$ 2,572.11
3	Hermosa/Fernwood - T&M Tag (11/13/2023)	LS	1	\$ 10,690.72	\$ 10,690.72
4	Zayante - T&M Tag (11/22/2023)	LS	1	\$ 5,237.17	\$ 5,237.17
Total Cost					\$ 26,147.76

**Requested Project Extension (Construction Activities) – 2.50 Day(s)*

Please do not hesitate to contact me at (650) 455-8985, if you should have any questions

Adrian Power

JMB Construction, Inc.

Project Manager

APPENDIX A

DAILY EXTRA WORK REPORT

Agenda: 4.4.24
~~Thursday~~
 Item: 10a

PROJECT TITLE: CIP Pipeline Project
 JOB NO: 938
 LOCATION: CA-9 (Brookside and Tucumita Connections)

REPORT NO: 938.100.20.230.10
 DATE PERFORMED: 11/09/2023
 DATE OF REPORT: 11/10/2023

DESCRIPTION OF WORK: Additional costs associated with capping the existing leaking valves on CA-9 at Brookside Drive and Tucumita Woods Road per the response to RFI #13. Crew excavated down to existing valve, removed existing main, installed valve and backfilled with Slurry.

LABOR			
EMPLOYEE NAME	CLASSIFICATION	REG HOURS	OT HOURS
<u>Jose Robles</u>	<u>F</u>	<u>5</u>	
<u>Ricardo Camacho</u>	<u>D</u>	<u>5</u>	
<u>Alonso Amador</u>	<u>L</u>	<u>5</u>	
<u>Proquinto Poniagua</u>	<u>L</u>	<u>5</u>	
<u>Jose Luis Acumburo</u>	<u>L</u>	<u>5</u>	
<u>Antonio Eleazar Archilla</u>	<u>L</u>	<u>5</u>	
<u>Antonio Ramos</u>	<u>L</u>	<u>5</u>	

EQUIPMENT - Manufacturer, Model, Capacity, Attachments, Weights, Axles, etc.	HOURS
<u>-Crew Truck (Ford F250)</u>	<u>5</u>
<u>-Skidsteer loader CAT248</u>	<u>5</u>
<u>-Loader L1106</u>	<u>5</u>
<u>-ECR88 Excavator</u>	<u>5</u>
<u>-Chevy Site Truck</u>	<u>5</u>
<u>-Laymor Sweeper</u>	<u>5</u>
<u>-10-Wheeler</u>	<u>5</u>

MATERIALS, RENTAL EQUIPMENT, SUBCONTRACTORS & WORK BY SPECIAL FORCES	NO. UNIT
<u>- Pipe Caps and Associated Materials.</u>	<div style="text-align: center;">↓</div>
<u>- Slurry 4 yards Granite Rock.</u>	
	Calculate @ End w/ Invoices.

[Signature]
 Submitted - Contractor's Representative

11/10/2023
 Date

Approved - Project Inspector

Date

CHANGE ORDER REQUEST/PROPOSAL REPORT

Agenda: 4.4.24
Item: 10a
REPORT NO: 938.100.20.230.10

PROJECT TITLE: SLVWD - 2021 CIP Pipeline Project

DAY: Thursday

PROJECT NO: 938

DATE PERFORMED: 11/9/2023

LOCATION: CA-9 (Brookside & Juanita)

DATE OF REPORT: 11/10/2023

WORK PERFORMED BY: JMB Construction, Inc.

DESCRIPTION OF WORK: Additional costs associated with capping the existing leaking valves on CA-9 on Brookside Drive & Juanita Woods Road per the response to RFI #13. Crew excavated down to the existing valve, removed a portion of the existing main, installed valve cap & backfilled w/ slurry.

NO.	EQUIPMENT	HOURS/ DAY	HOURLY RATE	EXTENDED AMOUNTS	NO.	LABOR	HOURS	HOURLY RATE	EXTENDED AMOUNTS
1	Crew Truck (F250)	5	\$42.39	\$ 211.95	1	Jose Robles	O.T. 0	\$168.01	\$ -
1	Skidsteer Loaders (CAT 248's)	5	\$37.72	\$ 188.60			Reg. 5	\$121.89	\$ 609.45
1	Rubber Tire Loader Volvo L110G	5	\$139.07	\$ 695.35	1	Ricardo Camacho	O.T. 0	\$157.99	\$ -
1	Excavator Volvo ECR88	5	\$50.42	\$ 252.10			Reg. 5	\$116.88	\$ 584.40
1	JMB Site Truck (Chevrolet)	5	\$37.61	\$ 188.05	1	Alonso Amador	O.T. 0	\$104.07	\$ -
1	Laymor Sweeper	5	\$55.95	\$ 279.75			Reg. 5	\$79.26	\$ 396.30
1	10-Wheeler (3-Axle)	5	\$93.59	\$ 467.95	1	Pioquinto Paniagua	O.T. 0	\$112.06	\$ -
				\$ -			Reg. 5	\$84.59	\$ 422.95
				\$ -	1	Jose Luis Aramburo	O.T. 0	\$104.07	\$ -
				\$ -			Reg. 5	\$79.26	\$ 396.30
				\$ -	1	Antonio Eleazar Archilla	O.T. 0	\$108.07	\$ -
				\$ -			Reg. 5	\$81.92	\$ 409.60
				\$ -	1	Antonio Ramos	O.T. 0	\$100.07	\$ -
				\$ -			Reg. 5	\$76.60	\$ 383.00
MATERIAL, RENTAL EQUIPMENT & WORK by SPECIAL FORCES							O.T.		\$ -
DESCRIPTION		NO.UNIT	UNIT COST				Reg.		\$ -
Material (See UR Invoice #S100013853.001)		1	\$581.44	\$ 581.44	TOTAL COST OF LABOR A				\$ 3,202.00
Slurry (See Granite Rock Invoice #2127645)		1	\$885.32	\$ 885.32	TOTAL COST OF EQUIP B				\$ 2,283.75
				\$ -	TOTAL COST OF MATERIAL C				\$ 1,466.76
				\$ -	10% ON LABOR (A)				\$ 320.20
				\$ -	10% EQUIP (B)				\$ 228.38
				\$ -	10% ON MATERIAL (C)				\$ 146.68
				\$ -	TOTAL THIS REPORT				\$ 7,647.76
TOTAL COST OF EQUIP, MATERIALS & WORK BY SPECIAL FORCES				\$ 3,750.51					



UNDERGROUND REPUBLIC WATER WORKS
 2882 SPRING ST
 REDWOOD CITY-, CA 94063
 Phone 650-955-7473
 Fax XXX-XXX-XXXX



Invoice

INVOICE DATE	INVOICE NUMBER
11/09/2023	S100013853.001
REMIT TO: UNDERGROUND REPUBLIC WATER WORKS 1175 CAMPBELL AVE SAN JOSE, CA 95126	PAGE NO. 1 of 1

BILL TO:

SHIP TO:

JMB CONSTRUCTION INC.
 132 SOUTH MAPLE AVE.
 SOUTH SAN FRANCISCO, CA 94080

JMB CONSTRUCTION INC.
 132 SOUTH MAPLE AVE.
 SOUTH SAN FRANCISCO, CA 94080

CUSTOMER NUMBER	CUSTOMER PO NUMBER	JOB NAME / RELEASE NUMBER	SALESPERSON		
681	938		HOUSE 1 ACCOUNT		
WRITER		SHIP VIA	TERMS	SHIP DATE	ORDERED BY
Rory Gamblin		WILL CALL	Net 30 Days	11/09/2023	ADRIAN
ORDER QTY	SHIP QTY	DESCRIPTION	UNIT PRICE	EXT PRICE	
2ea	2ea	4 MJ CAP SOLID C153 TC	36.667/ea	73.33	
3ea	3ea	4 EBAA MEGALUG F/DI 1104	47.086/ea	141.26	
1ea	1ea	4 EBAA MEGALUG F/PVC 2004PV	57.812/ea	57.81	
4ea	4ea	4 MJ GASKET	8.800/ea	35.20	
16ea	16ea	3/4X4 316SS T-HEAD BOLT & HEAVY HEX NUT	14.000/ea	224.00	

Invoice is due by 12/09/2023

Past Due invoices may be subject to 0% late charge.

Subtotal	531.60
S&H Charges	0.00
Tax	49.84
Payments	0.00
Amount Due	581.44



P.O. Box 50001
Watsonville, CA 95077-5001
(831) 768-2000

Customer: 40067

Invoice No: 2127645
Invoice Date: 11/11/2023
Job No:
Order No: 2110478
Job PO No: TBD
Job Name: SLVWD CIP Pipeline
Job Street: 205 Brookside Dr Boulder Creek
Job City: Boulder Creek

JMB Construction*PO Req.**
132 South Maple Avenue
South San Francisco, CA 94080

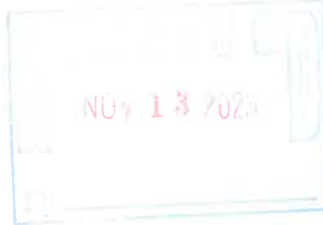

Concrete

Product	Qty	Product Price	Amount	Freight Price	Freight Amount	Additional Charges	Tax Amount	Total	
Date: 11/06/2023 Ticket: 425457 Location: Santa Cruz Concrete									
002200SC 2.0 SK CDF / CLSM SC SAND	9.00	Cu Yd 130.00	1,170.00			45.00	9.00%	105.30	1,320.30
000FSC Fuel Surcharge- Concrete	1.00	EA 18.00	18.00				9.00%	1.62	19.62
00ERFC Environmental Recovery Fee Concrete	1.00	EA 35.00	35.00				9.00%	3.15	38.15
X09013 Mixer Driver Overtime (Min)	60.00	MN 3.00	180.00				9.00%	16.20	196.20
Totals for Ticket 425457			1,403.00	0.00	45.00	126.27		1,574.27	

Date: 11/09/2023 Ticket: 425568 Location: Santa Cruz Concrete									
002200SC 2.0 SK CDF / CLSM SC SAND	4.00	Cu Yd 130.00	520.00			20.00	9.00%	46.80	586.80
X02152 4-5.75 Yd Short Load Premium	1.00	EA 175.00	175.00				9.00%	15.75	190.75
000FSC Fuel Surcharge- Concrete	1.00	EA 18.00	18.00				9.00%	1.62	19.62
00ERFC Environmental Recovery Fee Concrete	1.00	EA 35.00	35.00				9.00%	3.15	38.15
000551 Dump-Wet Concrete 1-3 CY	1.00	EA 50.00	50.00				9.00%	0.00	50.00
Totals for Ticket 425568			798.00	0.00	20.00	67.32		885.32	

Summary of Additional Charges

Prevailing Wage Administrative Fee 65.00

Product	Freight	Additional	Tax	Total	
Invoice Totals	2,201.00	0.00	65.00	193.59	2,459.59

For questions, or additional info, contact Customer Service at (831) 768-2120 or CustomerServiceAll@graniterock.com

DAILY EXTRA WORK REPORT

Agenda: 4.4.24
Friday
 Item: 10a

PROJECT TITLE: CIP Pipeline Project
 JOB NO: 938
 LOCATION: CA-9 (Brookside and Juanita)

REPORT NO: 938.100.20.230.20
 DATE PERFORMED: 11/10/2023
 DATE OF REPORT: 11/10/2023

DESCRIPTION OF WORK: Crew returned today to remove the plates and pave the 2nd. Valve abandonment areas.

LABOR			
EMPLOYEE NAME	CLASSIFICATION	REG HOURS	OT HOURS
<u>Jose Robles</u>	<u>F</u>	<u>2</u>	
<u>Ricardo Camacho</u>	<u>O</u>	<u>2</u>	
<u>Alonso Amador</u>	<u>L</u>	<u>2</u>	
<u>Pedrinho Francisco</u>	<u>L</u>	<u>2</u>	
<u>Jose Luis Acamburo</u>	<u>L</u>	<u>2</u>	
<u>Antonio Eleazar Archilla</u>	<u>L</u>	<u>2</u>	
<u>Antonio Ramos</u>	<u>L</u>	<u>2</u>	

EQUIPMENT - Manufacturer, Model, Capacity, Attachments, Weights, Axles, etc.	HOURS
<u>-Crew Truck (Ford F250)</u>	<u>2</u>
<u>-Skidsteer loader CAT248</u>	<u>2</u>
<u>-Loader L110G</u>	<u>2</u>
<u>-Lumpax Sweeper</u>	<u>2</u>
<u>-10-Wheelers</u>	<u>2</u>

MATERIALS, RENTAL EQUIPMENT, SUBCONTRACTORS & WORK BY SPECIAL FORCES	NO. UNIT
<u>-AC Granite Construction (3 Tons)</u>	↓
	<u>Calculate @ Encl w/ Invoices</u>

[Signature]
 Submitted - Contractor's Representative

11/10/2023
 Date

Approved - Project Inspector

Date

CHANGE ORDER REQUEST/PROPOSAL REPORT

Agenda: 4.4.24
Item: 10a
REPORT NO: 938.100.20.230.20

PROJECT TITLE: SLVWD - 2021 CIP Pipeline Project

DAY: Friday

PROJECT NO: 938

DATE PERFORMED: 11/10/2023

LOCATION: CA-9 (Brookside & Juanita)

DATE OF REPORT: 11/10/2023

WORK PERFORMED BY: JMB Construction, Inc.

DESCRIPTION OF WORK: Crew returned today to remove the plates and pave the 2 No. Valve Abaonment excavations.

NO.	EQUIPMENT	HOURS/ DAY	HOURLY RATE	EXTENDED AMOUNTS	NO.	LABOR	HOURS	HOURLY RATE	EXTENDED AMOUNTS
1	Crew Truck (F250)	2	\$ 42.39	\$ 84.78	1	Jose Robles	O.T. 0	\$168.01	\$ -
1	Skidsteer Loaders (CAT 248's)	2	\$ 37.72	\$ 75.44			Reg. 2	\$121.89	\$ 243.78
1	Rubber Tire Loader Volvo L110G	2	\$ 139.07	\$ 278.14	1	Ricardo Camacho	O.T. 0	\$157.99	\$ -
1	Laymor Sweeper	2	\$ 55.95	\$ 111.90			Reg. 2	\$116.88	\$ 233.76
1	10-Wheeler (3-Axle)	2	\$ 93.59	\$ 187.18	1	Alonso Amador	O.T. 0	\$104.07	\$ -
				\$ -			Reg. 2	\$79.26	\$ 158.52
				\$ -	1	Pioquinto Paniagua	O.T. 0	\$112.06	\$ -
				\$ -			Reg. 2	\$84.59	\$ 169.18
				\$ -	1	Jose Luis Aramburo	O.T. 0	\$104.07	\$ -
				\$ -			Reg. 2	\$79.26	\$ 158.52
				\$ -	1	Antonio Eleazar Archilla	O.T. 0	\$108.07	\$ -
				\$ -			Reg. 2	\$81.92	\$ 163.84
				\$ -	1	Antonio Ramos	O.T. 0	\$100.07	\$ -
				\$ -			Reg. 2	\$76.60	\$ 153.20
MATERIAL, RENTAL EQUIPMENT & WORK by SPECIAL FORCES							O.T.		\$ -
DESCRIPTION		NO.UNIT	UNIT COST				Reg.		\$ -
AC (See Granite Invoice #2608823)		1	\$320.04	\$ 320.04					
				\$ -					
				\$ -					
				\$ -					
				\$ -					
				\$ -					
				\$ -					
TOTAL COST OF EQUIP, MATERIALS & WORK BY SPECIAL FORCES				\$ 1,057.48					
TOTAL COST OF LABOR A									\$ 1,280.80
TOTAL COST OF EQUIP B									\$ 737.44
TOTAL COST OF MATERIAL C									\$ 320.04
10% ON LABOR (A)									\$ 128.08
10% EQUIP (B)									\$ 73.74
10% ON MATERIAL (C)									\$ 32.00
TOTAL THIS REPORT									\$ 2,572.11

INVOICE



PLEASE MAIL REMITTANCE TO:

Granite Construction Company
PO Box 742478
Los Angeles, CA 90074-2478

INVOICE DATE: 11/10/2023

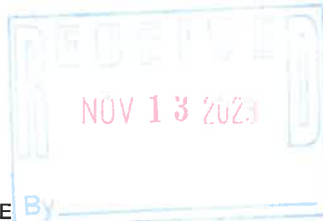

Bill To:

JMB CONSTRUCTION INC
132 SOUTH MAPLE AVENUE
SOUTH SAN FRANCISCO CA 94080-6302
MGOAN@JMBCONSTRUCTION.COM

ORDER NO.	CUSTOMER NO.	PLANT	INVOICE NO.
295439	294825	FELTON A.C PLANT 201815 100321	2608823
ORIGINAL INVOICE #		JOB ADDRESS	DATE OF SALE
		SLVWD -CIP PIPELINE -BEN LOMOND 9500 BROOKSIDE AVENUE BEN LOMOND CA 95005	11/10/2023
			PO #
			938

A LATE FEE OF 1.5% PER MONTH (18% PER ANNUM) WILL BE APPLIED ON PAST DUE BALANCES

A CREDIT CARD FEE OF 2.3% WILL BE APPLIED TO ALL CREDIT CARD PAYMENTS MADE MORE THAN 10 BUSINESS DAYS AFTER THE INVOICE DATE ABOVE

TICKET NUMBER	TICKET DATE	MATERIAL DESCRIPTION	QTY	UNIT PRICE	EXTENDED AMOUNT	FOB	TAX RATE AREA
44582149	11/10/2023	1056 - 1/2"HMA64-10R15	5.710 TN	98.000	\$559.58	P	V050870000
44582156	11/10/2023	1056 - 1/2"HMA64-10R15	2.000 TN	98.000	\$196.00	P	V050870000
		TOTAL: 1056 - 1/2"HMA64-10R15	7.7100 TN		\$755.58		

3 Tons of AC

3 * \$98.00 + Tax = \$320.04

TERMS: A/R Net 30 Days

The prevailing party shall be entitled to reasonable attorney's fees and costs in any action to collect the amounts due hereunder.

Note: If haul charges are indicated separately above, then the title passage of materials is at the plant, with delivery provided for customers.

The environmental fee is not a tax, surcharge, or fee mandated by or remitted to any governmental or regulatory agency but used to recover direct and indirect costs for Granite and its subsidiaries operations to be conducted in an environmentally sustainable manner.

For any question regarding this billing, please call (831)768-4002.

TOTAL FREIGHT	.00
MATERIAL	755.58
FEES	.00
SALES TAX	68.00

FOB: P=PLANT J=JOB

FOR OFFICIAL USE ONLY

Thank You for your business.

INVOICE TOTAL

WARNING: THIS PRODUCT CONTAINS A CHEMICAL KNOWN TO THE STATE OF CALIFORNIA TO CAUSE CANCER, BIRTH DEFECTS OR OTHER REPRODUCTIVE HARM. MSDS SHEETS AVAILABLE AT WWW.GRANITECONSTRUCTION.COM/MSDS OR BY CONTACTING YOUR LOCAL OFFICE.

\$823.58

DAILY EXTRA WORK REPORT

Agenda: 4.4.24
~~Item: 70a~~

PROJECT TITLE: CIP Pipeline Project
 JOB NO: 938
 LOCATION: Hermosa/Fernwood and Glen Arbor.

REPORT NO: 938.100.20.230.30
 DATE PERFORMED: 11/13/2023
 DATE OF REPORT: 11/21/2023

DESCRIPTION OF WORK: Additional costs associated with capping the existing leaking valves on Glen Arbor at Hermosa Ave. and Fernwood Ave. per the response to RFI #13.

LABOR			
EMPLOYEE NAME	CLASSIFICATION	REG HOURS	OT HOURS
Jose Robles	F	8	
Ricardo Camacho	D	8	
Alonso Amador	L	8	
Pioquinto Paniagua	L	8	
Jose Luis Aramburo	L	8	
Antonio Eleazar Archilla	L	8	
Antonio Ramos	L	8	

EQUIPMENT - Manufacturer, Model, Capacity, Attachments, Weights, Axles, etc.	HOURS
- Crew Truck (Ford F250)	8
- Skidsteer loader CAT268	8
- Loader L1106	8
- ECR88 Excavator	8
- Chevy Site Truck	8
- JMB Pipe Truck	8
- Laymor Sweeper	8
- 10-Wheelers	8

MATERIALS, RENTAL EQUIPMENT, SUBCONTRACTORS & WORK BY SPECIAL FORCES	NO. UNIT
- Pipe Caps and Associated Material	
- AC	
	Calculate @ incl w/ Invoices

Submitted - Contractor's Representative

11/21/2023
 Date

Approved - Project Inspector

Date

CHANGE ORDER REQUEST/PROPOSAL REPORT

Agenda: 4.4.24
 Item: 10a
REPORT NO: 938.100.20.230.30

PROJECT TITLE: SLVWD - 2021 CIP Pipeline Project

DAY: Monday

PROJECT NO: 938

DATE PERFORMED: 11/13/2023

LOCATION: Hermosa/Fernwood & Glen Arbor

DATE OF REPORT: 11/21/2023

WORK PERFORMED BY: JMB Construction, Inc.

DESCRIPTION OF WORK: Additional costs associated with capping the existing leaking valves on Glen Arbor at Hermosa Avenue & Fernwood Avenue per the response to RFI #13.

NO.	EQUIPMENT	HOURS/ DAY	HOURLY RATE	EXTENDED AMOUNTS	NO.	LABOR	HOURS	HOURLY RATE	EXTENDED AMOUNTS	
1	Crew Truck (F250)	8	\$42.39	\$ 339.12	1	Jose Robles	O.T. 0	\$168.01	\$ -	
1	Skidsteer Loader (CAT 248's)	8	\$37.72	\$ 301.76			Reg. 8	\$121.89	\$ 975.12	
1	Rubber Tire Loader Volvo L110G	8	\$139.07	\$ 1,112.56	1	Ricardo Camacho	O.T. 0	\$157.99	\$ -	
1	Excavator Volvo ECR88	8	\$50.42	\$ 403.36			Reg. 8	\$116.88	\$ 935.04	
1	JMB Site Truck (Chevrolet)	8	\$37.61	\$ 300.88	1	Alonso Amador	O.T. 0	\$104.07	\$ -	
1	JMB Pipe Truck (2 Axle)	8	\$64.30	\$ 514.40			Reg. 8	\$79.26	\$ 634.08	
1	Laymor Sweeper	8	\$55.95	\$ 447.60	1	Pioquinto Paniagua	O.T. 0	\$112.06	\$ -	
1	10-Wheeler (3-Axle)	8	\$93.59	\$ 748.72			Reg. 8	\$84.59	\$ 676.72	
				\$ -	1	Jose Luis Aramburo	O.T. 0	\$104.07	\$ -	
				\$ -			Reg. 8	\$79.26	\$ 634.08	
				\$ -	1	Antonio Eleazar Archilla	O.T. 0	\$108.07	\$ -	
				\$ -			Reg. 8	\$81.92	\$ 655.36	
				\$ -	1	Antonio Ramos	O.T. 0	\$100.07	\$ -	
				\$ -			Reg. 8	\$76.60	\$ 612.80	
MATERIAL, RENTAL EQUIPMENT & WORK by SPECIAL FORCES							O.T.		\$ -	
DESCRIPTION		NO.UNIT	UNIT COST				Reg.		\$ -	
AC (See Granite Invoice #2609610)		1	\$427.24	\$ 427.24						
				\$ -	TOTAL COST OF LABOR A				\$ 5,123.20	
				\$ -	TOTAL COST OF EQUIP B				\$ 4,168.40	
				\$ -	TOTAL COST OF MATERIAL C				\$ 427.24	
				\$ -	10% ON LABOR (A)				\$ 512.32	
				\$ -	10% EQUIP (B)				\$ 416.84	
				\$ -	10% ON MATERIAL (C)				\$ 42.72	
TOTAL COST OF EQUIP, MATERIALS & WORK BY SPECIAL FORCES				\$ 4,595.64					TOTAL THIS REPORT	\$ 10,690.72

INVOICE



PLEASE MAIL REMITTANCE TO:
Granite Construction Company
PO Box 742478
Los Angeles, CA 90074-2478

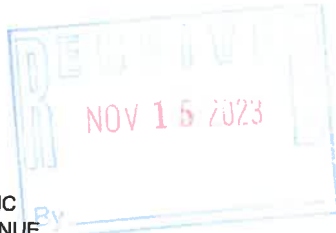

INVOICE DATE: 11/13/2023

Bill To:

JMB CONSTRUCTION INC
132 SOUTH MAPLE AVENUE
SOUTH SAN FRANCISCO CA 94080-6302
MGOAN@JMBCONSTRUCTION.COM

ORDER NO.	CUSTOMER NO.	PLANT	INVOICE NO.
295439	294825	FELTON A.C PLANT 201815 100321	2609610
ORIGINAL INVOICE #		JOB ADDRESS	DATE OF SALE
		SLVWD -CIP PIPELINE -BEN LOMOND 9500 BROOKSIDE AVENUE BEN LOMOND CA 95005	11/13/2023
			PO #
			938

A LATE FEE OF 1.5% PER MONTH (18% PER ANNUM) WILL BE APPLIED ON PAST DUE BALANCES

A CREDIT CARD FEE OF 2.3% WILL BE APPLIED TO ALL CREDIT CARD PAYMENTS MADE MORE THAN 10 BUSINESS DAYS AFTER THE INVOICE DATE ABOVE

TICKET NUMBER	TICKET DATE	MATERIAL DESCRIPTION	QTY	UNIT PRICE	EXTENDED AMOUNT	FOB	TAX RATE AREA
44582174	11/13/2023	1056 - 1/2"HMA64-10R15	4.080	TN	98.000	\$399.84	P V050870000
TOTAL:		1056 - 1/2"HMA64-10R15	4.0800	TN		\$399.84	
31631671	11/13/2023	1946 - DUMP CHARGE	9.540	EA	20.000	\$190.80	P V050870000
31631766	11/13/2023	1946 - DUMP CHARGE	2.180	EA	20.000	\$43.60	P V050870000
TOTAL:		1946 - DUMP CHARGE	11.7200	EA		\$234.40	

~4 Tons of AC
4 * \$98.00 + Tax = \$427.24

TERMS: A/R Net 30 Days

The prevailing party shall be entitled to reasonable attorney's fees and costs in any action to collect the amounts due hereunder.
Note: If haul charges are indicated separately above, then the title passage of materials is at the plant, with delivery provided for customers.
The environmental fee is not a tax, surcharge, or fee mandated by or remitted to any governmental or regulatory agency but used to recover direct and indirect costs for Granite and its subsidiaries operations to be conducted in an environmentally sustainable manner.
For any question regarding this billing, please call (831)768-4002.

TOTAL FREIGHT	.00
MATERIAL	634.24
FEES	.00
SALES TAX	35.99

FOB: P=PLANT J=JOB

FOR OFFICIAL USE ONLY

Thank You for your business.

WARNING: THIS PRODUCT CONTAINS A CHEMICAL KNOWN TO THE STATE OF CALIFORNIA TO CAUSE CANCER, BIRTH DEFECTS OR OTHER REPRODUCTIVE HARM. MSDS SHEETS AVAILABLE AT WWW.GRANITECONSTRUCTION.COM/MSDS OR BY CONTACTING YOUR LOCAL OFFICE.

INVOICE TOTAL

\$670.23

DAILY EXTRA WORK REPORT

Agenda: 4.4.24
Item: 10a

PROJECT TITLE: CIP Pipeline Project
 JOB NO: 938
 LOCATION: East Zayante Road and Zayante Drive

REPORT NO: 938.100.20.230.40
 DATE PERFORMED: 11/22/2023
 DATE OF REPORT: 11/28/2023

DESCRIPTION OF WORK: Additional costs associated with abandoning the existing leaking valve on Zayante Drive per the response to RFI #13.

LABOR			
EMPLOYEE NAME	CLASSIFICATION	REG HOURS	OT HOURS
<u>Jose Robles</u>	<u>F</u>	<u>4</u>	
<u>Ricardo Camacho</u>	<u>O</u>	<u>4</u>	
<u>Alonso Amador</u>	<u>L</u>	<u>4</u>	
<u>Pioquinto Poncegna</u>	<u>L</u>	<u>4</u>	
<u>Jose Luis Aramburo</u>	<u>L</u>	<u>4</u>	
<u>Antonio Eleazar Archillo</u>	<u>L</u>	<u>4</u>	
<u>Antonio Ramos</u>	<u>L</u>	<u>4</u>	

EQUIPMENT - Manufacturer, Model, Capacity, Attachments, Weights, Axles, etc.	HOURS
<u>Crew Truck (Ford F250)</u>	<u>4</u>
<u>Loader L1106</u>	<u>4</u>
<u>ECR58 Excavator</u>	<u>4</u>
<u>Chevy Site Truck</u>	<u>4</u>
<u>Lynx Sweeper</u>	<u>4</u>
<u>Bobtail</u>	<u>4</u>

MATERIALS, RENTAL EQUIPMENT, SUBCONTRACTORS & WORK BY SPECIAL FORCES	NO. UNIT
<u>- 1 No. 4" Hyman Coupling / End Cap / MJ Coupling + Mega Lug.</u>	↓
<u>* Material purchased previously *</u>	
<u>* 2 LF of 6" DIP - Bill through Bid Item *</u>	↓
	<u>Calculate @ End w/ Invoices</u>

[Signature]
 Submitted - Contractor's Representative

11/28/2023
 Date

Approved - Project Inspector

Date

CHANGE ORDER REQUEST/PROPOSAL REPORT

Agenda: 4.4.24
 Item: 10a
REPORT NO: 938.100.20.230.40

PROJECT TITLE: SLVWD - 2021 CIP Pipeline Project

DAY: Wednesday

PROJECT NO: 938

DATE PERFORMED: 11/22/2023

LOCATION: East Zayante & Zayante Drive

DATE OF REPORT: 11/28/2023

WORK PERFORMED BY: JMB Construction, Inc.

DESCRIPTION OF WORK: Additional costs associated with capping the existing leaking valves on Zayante Drive per the response to RFI #13.

NO.	EQUIPMENT	HOURS/ DAY	HOURLY RATE	EXTENDED AMOUNTS	NO.	LABOR	HOURS	HOURLY RATE	EXTENDED AMOUNTS	
1	Crew Truck (F250)	4	\$42.39	\$ 169.56	1	Jose Robles	O.T. 0	\$168.01	\$ -	
1	Rubber Tire Loader Volvo L110G	4	\$139.07	\$ 556.28			Reg. 4	\$121.89	\$ 487.56	
1	Excavator Volvo ECR58	4	\$53.81	\$ 215.24	1	Ricardo Camacho	O.T. 0	\$157.99	\$ -	
1	JMB Site Truck (Chevrolet)	4	\$37.61	\$ 150.44			Reg. 4	\$116.88	\$ 467.52	
1	Laymor Sweeper	4	\$55.95	\$ 223.80	1	Alonso Amador	O.T. 0	\$104.07	\$ -	
1	Bobtail (2-Axle)	4	\$ 73.34	\$ 293.36			Reg. 4	\$79.26	\$ 317.04	
				\$ -	1	Pioquinto Paniagua	O.T. 0	\$112.06	\$ -	
				\$ -			Reg. 4	\$84.59	\$ 338.36	
				\$ -	1	Jose Luis Aramburo	O.T. 0	\$104.07	\$ -	
				\$ -			Reg. 4	\$79.26	\$ 317.04	
				\$ -	1	Antonio Eleazar Archilla	O.T. 0	\$108.07	\$ -	
				\$ -			Reg. 4	\$81.92	\$ 327.68	
				\$ -	1	Antonio Ramos	O.T. 0	\$100.07	\$ -	
				\$ -			Reg. 4	\$76.60	\$ 306.40	
MATERIAL, RENTAL EQUIPMENT & WORK by SPECIAL FORCES							O.T.		\$ -	
		NO.UNIT	UNIT COST				Reg.		\$ -	
	4" Material (See Ferguson Invoice #1810251)	1	\$209.28	\$ 209.28	TOTAL COST OF LABOR A					\$ 2,561.60
	4" Material (See Ferguson Invoice #1824318)	1	\$381.50	\$ 381.50						TOTAL COST OF EQUIP B
				\$ -	TOTAL COST OF MATERIAL C					
				\$ -						10% ON LABOR (A)
				\$ -	10% EQUIP (B)					
				\$ -						10% ON MATERIAL (C)
				\$ -	TOTAL THIS REPORT					
TOTAL COST OF EQUIP, MATERIALS & WORK BY SPECIAL FORCES				\$ 2,199.46						

FERGUSON
WATERWORKS
66 TARP CIRCLE
SALINAS, CA 93901-3717

INVOICE NUMBER	TOTAL DUE	CUSTOMER	PAGE
1810251	\$5,272.04	454930	1 of 1

PLEASE REFER TO INVOICE NUMBER WHEN MAKING PAYMENT AND REMIT TO:

FERGUSON WATERWORKS #1423
PO BOX 740827
LOS ANGELES, CA 90074-0827

MASTER ACCOUNT NUMBER: 230316

SHIP TO:

JMB CONSTRUCTION INC
70 RIDGE DR
SLVWD - 2021 CIP PIPELINE PROJ
BOULDER CREEK, CA 95006

Please contact with Questions: 916-381-6100



JMB CONSTRUCTION INC
132 SOUTH MAPLE AVE
SLVWD - 2021 CIP PIPELINE
SOUTH SAN FRANCISCO, CA 94080-6320

SHIP WHSE.	SELL WHSE.	TAX CODE	CUSTOMER ORDER NUMBER	SALESMAN	JOB NAME	INVOICE DATE	BATCH
3306	3306	CA44	4"X18'0 SPOOL	GEW	SLVWD - 2021 CIP PIPELINE	09/25/23	IO 90319
ORDERED	SHIPPED	ITEM NUMBER	DESCRIPTION	UNIT PRICE	UM	AMOUNT	
1	1	FFPELP18	JOSE 415.559.0340 4X18'0 FLGXFLG EPOX DI SPL	4000.000	EA	4000.00	
2	2	MJELFALAP	4 MJXFE C153 ADPT EPOX	130.000	EA	260.00	
2	2	FNWNBSS41P	4 304 SS 150# FLG NUT/BLT SET	30.000	EA	60.00	
2	2	UFTF04S	4 FLG TYTE 1/8 150# FF GSKT SBR	14.000	EA	28.00	
2	2	SSLDEP4	4 DI MJ WDG REST GLND PK *ONELOK	48.000	EA	96.00	
1	1	FELTP	4 FLG EPOX LINED TEE	392.729	EA	392.73	
INVOICE SUB-TOTAL						4836.73	
TAX						435.31	
ITEM CODE						DESCRIPTION	NOTICE
FNWNBSS41P						4 304 SS 150# FLG NUT/BLT SET	<I> WARNING: Cancer and Reproductive Harm - www.P65Warnings.ca.gov
<p>LEAD LAW WARNING: IT IS ILLEGAL TO INSTALL PRODUCTS THAT ARE NOT "LEAD FREE" IN ACCORDANCE WITH US FEDERAL OR OTHER APPLICABLE LAW IN POTABLE WATER SYSTEMS ANTICIPATED FOR HUMAN CONSUMPTION. PRODUCTS WITH *NP IN THE DESCRIPTION ARE NOT LEAD FREE AND CAN ONLY BE INSTALLED IN NON-POTABLE APPLICATIONS. BUYER IS SOLELY RESPONSIBLE FOR PRODUCT SELECTION.</p> <p>WATER FLOW RATE NOTICE: LAVATORY FAUCETS WITH FLOW RATES OVER 0.5 GPM ARE NOT ALLOWED FOR 'PUBLIC USE' IN CALIFORNIA.</p>							
<div style="border: 2px solid red; padding: 10px; width: fit-content; margin: 0 auto;"> <p>4" Adaptor = 1 * \$130.00 + Tax = \$141.70 4" Gasket = 1 * \$14.00 + Tax = \$15.26 4" MJ = 1 * \$48.00 + Tax = \$52.32 Total = \$209.28</p> </div>							
<p>Looking for a more convenient way to pay your bill?</p> <p>Log in to Ferguson.com and request access to Online Bill Pay.</p>							

TERMS: NET 10TH PROX	ORIGINAL INVOICE	TOTAL DUE	\$5,272.04
----------------------	------------------	-----------	------------

All past due amounts are subject to a service charge of 1.5% per month, or the maximum allowed by law, if lower. If Buyer fails to pay within terms, then in addition to other remedies, Buyer agrees to pay Seller all costs of collection, including reasonable attorney fees. Complete terms and conditions are available upon request or at <https://www.ferguson.com/content/website-info/terms-of-sale>, incorporated by reference. Seller may convert checks to ACH.

FERGUSON
WATERWORKS
27750 INDUSTRIAL BLVD
HAYWARD, CA 94545-3629

INVOICE NUMBER	TOTAL DUE	CUSTOMER	PAGE
1824318	\$1,402.97	454930	1 of 1

**PLEASE REFER TO INVOICE NUMBER WHEN
MAKING PAYMENT AND REMIT TO:**

Please contact with Questions: 510-786-3333

FERGUSON WATERWORKS #1423
PO BOX 740827
LOS ANGELES, CA 90074-0827

MASTER ACCOUNT NUMBER: 230316

SHIP TO:

JMB CONSTRUCTION INC
132 SOUTH MAPLE AVE
SLVWD - 2021 CIP PIPELINE
SOUTH SAN FRANCISCO, CA 94080-6320



COUNTER PICK UP
27750 INDUSTRIAL BLVD
HAYWARD, CA 94545-3629

SHIP WHSE.	SELL WHSE.	TAX CODE	CUSTOMER ORDER NUMBER	SALESMAN	JOB NAME	INVOICE DATE	BATCH
3300	3300	CA01HA	LEAVE OUTSIDE	GEW	SLVWD - 2021 CIP PIPELINE	10/30/23	IO 90822
ORDERED	SHIPPED	ITEM NUMBER	DESCRIPTION	UNIT PRICE	UM	AMOUNT	
2		2 MJEL4LAP	LEAVE OUTSIDE FOR CUSTOMER				
4		4 E1104DSC	4 MJ 45 C153 BEND EPOX	92.000	EA	184.00	
1		1 MJELRLAXU	4 MEGALUG ACC PKG W/ MJ GSMT F/ DI	56.697	EA	226.79	
1		1 MJELRLAXU	8X6 MJ C153 RED EPOX	155.999	EA	156.00	
2		2 K86054010816	4 HYMAX 2 REP COUP 4.25-5.63	350.000	EA	700.00	
INVOICE SUB-TOTAL							1266.79
TAX						Alameda/Hayward	136.18
<p>*****</p> <p>LEAD LAW WARNING: IT IS ILLEGAL TO INSTALL PRODUCTS THAT ARE NOT "LEAD FREE" IN ACCORDANCE WITH US FEDERAL OR OTHER APPLICABLE LAW IN POTABLE WATER SYSTEMS ANTICIPATED FOR HUMAN CONSUMPTION PRODUCTS WITH *NP IN THE DESCRIPTION ARE NOT LEAD FREE AND CAN ONLY BE INSTALLED IN NON-POTABLE APPLICATIONS. BUYER IS SOLELY RESPONSIBLE FOR PRODUCT SELECTION.</p> <p>*****</p> <p>WATER FLOW RATE NOTICE: LAVATORY FAUCETS WITH FLOW RATES OVER 0.5 GPM ARE NOT ALLOWED FOR 'PUBLIC USE' IN CALIFORNIA.</p>							
<div style="border: 2px solid yellow; padding: 5px; display: inline-block;"> <p>4" Hymax Coupling 1 * \$350.00 + Tax = \$381.50</p> </div>							
<p>Looking for a more convenient way to pay your bill?</p> <p>Log in to Ferguson.com and request access to Online Bill Pay.</p>							

TERMS: NET 10TH PROX	ORIGINAL INVOICE	TOTAL DUE	\$1,402.97
-----------------------------	-------------------------	------------------	-------------------

All past due amounts are subject to a service charge of 1.5% per month, or the maximum allowed by law, if lower. If Buyer fails to pay within terms, then in addition to other remedies, Buyer agrees to pay Seller all costs of collection, including reasonable attorney fees. Complete terms and conditions are available upon request or at <https://www.ferguson.com/content/website-info/terms-of-sale>, incorporated by reference. Seller may convert checks to ACH.

RFI RECORD

RFI NO: 013

CONTRACT NO: SLVWD Contract #22/23-03
PROJECT: 2021 CIP Pipeline Project
CONTRACTOR: JMB Construction, Inc.
SUBJECT: Existing Abandoned Watermain
SUBMITTAL #: N/A **DWG. NO:** N/A
PAGE NO: N/A **SUBCONTRACTOR:** N/A

CITY USE ONLY	
Receipt Date:	_____
Directed To:	_____
Transfer Date:	_____
Returned Date:	_____
Date Returned to Contractor:	_____

PRIORITY: ROUTINE URGENT PLEASE EXPEDITE

INFORMATION/CLARIFICATION REQUIRED:

Contractor herein submits the following RFI regarding the Existing Abandoned Watermain at all four locations;

Contractor has plugged and abandoned the old watermain at multiple locations on this project. However, due to the condition of the existing valves, SLVWD has been unable to fully close the valves. Therefore, the old watermain is theoretically live and is continuously receiving water. Contractor recommends excavating at all valves in questions for all locations and capping these.

Please confirm how to proceed.

11/03/2023 *Adrian Power*
 Date Project Manager

RESPONSE/REPLY:

RFI #13
SANDIS RESPONSE (2023-11-03):

Proceed with capping existing valves at main tie in locations where necessary. Remove all surrounding valve infrastructure (riser, christy box, lid, etc.) and backfill accordingly to avoid future confusion.

CHRISTOPHER SMALL - SANDIS



2021 CIP Pipeline Project – Contract Change Order

March 22nd, 2024

Change Order No. 20

Contract No. 22/23-3

To: JMB Construction, Inc.

This Change Order No. 20 for the San Lorenzo Valley Water District’s 2021 CIP Pipeline Project encompasses the following changes to Contract No. 22/23-3:

1. Additional work to change the connections from tee fittings to hot tap connections for Juanita Woods and Brookside Drive at Highway 9 per the response of RFI #7 and indicated in JMB Construction Inc. Letter # 938.100.20.120.30.10 COR #12 – CA-9 8” DIP Main Connections.
2. Extension of Contract Time of one (1) calendar day, the project is now to be completed by 7/8/24.

Payment Adjustment at Agreed Lump Sum of \$9,400.07; Adjusted Contract Price is \$5,211,770.79

By signing this change order all parties agree to the preceding changes to the plans, specifications, and contract documents.

Brian Frus, Interim General Manager
San Lorenzo Valley Water District

Date: _____

Adrian Power, Project Manager
JMB Construction, Inc

Date: _____

Mike Kuykendall, P.E.
Engineer of Record, Sandis Civil Engineers

Date: _____



October 12th, 2023

JMB LTR #: 938.100.20.120.30.10

To: San Lorenzo Valley Water District,
136060 CA-9,
Boulder Creek, CA 95006.

Attention: Garrett Roffe & Cameron Slach

Project/Contract: 2021 – CIP Pipeline Project

Subject: **COR # 12 - CA-9 8" DIP Main Connections**

Garrett/Cameron,

This letter is to serve as a Change Order Request from JMB Construction, Inc. for the additional costs associated with the 2 No. Tie-Ins on Brookside Drive and Juanita Woods Road as described on the attached.

JMB Construction, Inc. has attached the Daily Extra Work Report Sheet(s) (See Attached in Appendix A) for the above additional costs. The following breakdown has been prepared based on the attached reports;

San Lorenzo Valley Water District – 2021 CIP Pipeline Project – COR # 08 ARV Terrace Drive Relocation

Item	Description	Unit	Quantity	Unit Price	Extension
1	CA-9 8" DIP Main Connections - T&M Tag (08/24/2023)	LS	1	\$ 9,400.07	\$ 9,400.07
Total					\$ 9,400.07

**Requested Project Extension (Construction Activities) – 0.25 Day(s)*

Please do not hesitate to contact me at (650) 455-8985, if you should have any questions

Adrian Power

JMB Construction, Inc.

Project Manager

APPENDIX A

DAILY EXTRA WORK REPORT

Agenda: 4.4.24
~~Thursday~~
 Item: 10a

PROJECT TITLE: CIP Pipeline Project
 JOB NO: 938
 LOCATION: CA-9 (Main Connections)

REPORT NO: 938.100.20.120.10
 DATE PERFORMED: 08/24/2023
 DATE OF REPORT: 09/16/2023

DESCRIPTION OF WORK: Additional work performed to facilitate the connections at both CA9 and Brookside/Jucunita following the response to RFI #07. Additional Excavation/Backfill, Materials and Installation.

LABOR			
EMPLOYEE NAME	CLASSIFICATION	REG HOURS	OT HOURS
Jose Robles	F	2	
Ricardo Camacho	O	2	
Alonso Amador	L	2	
Diego Quinto Parizaga	L	2	
Jose Luis Arcumburo	L	2	
Antonio E. Leonor Archilla	L	2	
Antonio Ramos	L	2	

EQUIPMENT - Manufacturer, Model, Capacity, Attachments, Weights, Axles, etc.	HOURS
- Crew Truck (Ford F250)	2
- 2 No. Skidsteers Loaders CAT 248'S	2
- Loader Rubber Tire L1106	2
- 3 No. Excavators (ECR 145, 88 and 58)	2
- JMB Pipe Truck and Site Truck	2
- JMB 10-Wheeler and 2 No. Bobtails	2

MATERIALS, RENTAL EQUIPMENT, SUBCONTRACTORS & WORK BY SPECIAL FORCES	NO. UNIT
- Additional Material (Tapping Sleeves, GV, Red., Couplings, Gaskets Bolt-Up Sets etc.)	
- Tapmaster	
- 2 yards of Slurry	
- 1 Ton of AC	
- 2 Ton of Sand	
	Calculate @ Encl w/ Invoices.

 Submitted - Contractor's Representative

09/16/2023
 Date

Approved - Project Inspector

Date

CHANGE ORDER REQUEST/PROPOSAL REPORT

Agenda: 4.4.24
Item: 10a
REPORT NO. 938.100.20.120.10

PROJECT TITLE: SLVWD - 2021 CIP Pipeline Project

DAY: Thursday

PROJECT NO: 938

DATE PERFORMED: 8/24/2023

LOCATION: CA-9 (Main Connectionc)

DATE OF REPORT: 9/16/2023

WORK PERFORMED BY: JMB Construction, Inc.

DESCRIPTION OF WORK: Additional work performed to facilitate the connections at both CA-9 and Brookside/Juanita following the response to RFI #07.
Additional Excavation/Backfill, Pipe Materials and Installation has been included.

NO.	EQUIPMENT	HOURS/ DAY	HOURLY RATE	EXTENDED AMOUNTS	NO.	LABOR	HOURS	HOURLY RATE	EXTENDED AMOUNTS	
1	Crew Truck (F250)	2	\$ 42.39	\$ 84.78	1	Jose Robles	O.T.	0	\$168.01	\$ -
2	Skidsteer Loaders (CAT 248's)	2	\$ 37.72	\$ 150.88			Reg.	2	\$121.89	\$ 243.78
1	Rubber Tire Loader Volvo L110G	2	\$ 139.07	\$ 278.14	1	Ricardo Camacho	O.T.	0	\$157.99	\$ -
1	Excavator Volvo ECR58	2	\$ 53.81	\$ 107.62			Reg.	2	\$116.88	\$ 233.76
1	Excavator Volvo ECR88	2	\$ 50.42	\$ 100.84	1	Alonso Amador	O.T.	0	\$104.07	\$ -
1	Excavator Volvo ECR145	2	\$ 78.26	\$ 156.52			Reg.	2	\$79.26	\$ 158.52
1	JMB Pipe Truck (2 Axle)	2	\$ 64.30	\$ 128.60	1	Pioquinto Paniagua	O.T.	0	\$112.06	\$ -
1	JMB Site Truck (Chevrolet)	2	\$ 37.61	\$ 75.22			Reg.	2	\$84.59	\$ 169.18
1	10-Wheeler (3-Axle)	2	\$ 93.59	\$ 187.18	1	Jose Luis Aramburo	O.T.	0	\$104.07	\$ -
2	Bobtail (2-Axle)	2	\$ 73.34	\$ 293.36			Reg.	2	\$79.26	\$ 158.52
				\$ -	1	Antonio Eleazar Archilla	O.T.	0	\$108.07	\$ -
				\$ -			Reg.	2	\$81.92	\$ 163.84
				\$ -	1	Antonio Ramos	O.T.	0	\$100.07	\$ -
				\$ -			Reg.	2	\$76.60	\$ 153.20
MATERIAL, RENTAL EQUIPMENT & WORK by SPECIAL FORCES							O.T.			\$ -
DESCRIPTION		NO.UNIT	UNIT COST				Reg.			\$ -
Tapping Sleeve (Ferguson Invoice #1809478)		1	\$1,687.32	\$ 1,687.32						
Gate Valve & Reducer (Ferguson Invoice #1808846-1)		1	\$1,571.54	\$ 1,571.54						
Gaskets & Bolt-Ups (Ferguson Invoice #1814236)		1	\$184.52	\$ 184.52						
Hot Tap (Tap Master Invoice #0823-114)		1	\$1,795.00	\$ 1,795.00						
2 Yds Slurry (See Granite Rock Invoice #2111971)		1	\$301.88	\$ 301.88						
1 Ton AC (See Granie Const. Invoice #2546905)		1	\$106.82	\$ 106.82						
2 Ton Sand (See Granite Const. Invoice #2544757)		1	\$54.50	\$ 54.50						
				\$ -						
TOTAL COST OF EQUIP, MATERIALS & WORK BY SPECIAL FORCES				\$ 7,264.72						
									TOTAL COST OF LABOR A	\$ 1,280.80
									TOTAL COST OF EQUIP B	\$ 1,563.14
									TOTAL COST OF MATERIAL C	\$ 5,701.58
									10% ON LABOR (A)	\$ 128.08
									10% EQUIP (B)	\$ 156.31
									10% ON MATERIAL (C)	\$ 570.16
									TOTAL THIS REPORT	\$ 9,400.07

FERGUSON®
WATERWORKS
27750 INDUSTRIAL BLVD
HAYWARD, CA 94545-3629

INVOICE NUMBER	TOTAL DUE	CUSTOMER	PAGE
1809478	\$1,687.32	454930	1 of 1

**PLEASE REFER TO INVOICE NUMBER WHEN
MAKING PAYMENT AND REMIT TO:**

FERGUSON WATERWORKS #1423
PO BOX 740827
LOS ANGELES, CA 90074-0827

MASTER ACCOUNT NUMBER: 230316

Please contact with Questions: 510-786-3333



JMB CONSTRUCTION INC
132 SOUTH MAPLE AVE
SLVWD - 2021 CIP PIPELINE
SOUTH SAN FRANCISCO, CA 94080-6320

SHIP TO:

JMB CONSTRUCTION INC
70 RIDGE DR
SLVWD - 2021 CIP PIPELINE PROJ
BOULDER CREEK, CA 95006

SHIP WHSE.	SELL WHSE.	TAX CODE	CUSTOMER ORDER NUMBER	SALESMAN	JOB NAME	INVOICE DATE	BATCH
3300	3300	CA44	8X6 HYD TAPN SLV	GEW	SLVWD - 2021 CIP PIPELINE	10/03/23	IO 90440

ORDERED	SHIPPED	ITEM NUMBER	DESCRIPTION	UNIT PRICE	UM	AMOUNT
1	1	J4320940X6	8 9.27 - 9.69 6 SS TAPN SLV	1548.000	EA	1548.00
INVOICE SUB-TOTAL						1548.00
TAX						139.32
TAX						139.32
<p>*****</p> <p>LEAD LAW WARNING: IT IS ILLEGAL TO INSTALL PRODUCTS THAT ARE NOT "LEAD FREE" IN ACCORDANCE WITH US FEDERAL OR OTHER APPLICABLE LAW IN POTABLE WATER SYSTEMS ANTICIPATED FOR HUMAN CONSUMPTION PRODUCTS WITH *NP IN THE DESCRIPTION ARE NOT LEAD FREE AND CAN ONLY BE INSTALLED IN NON-POTABLE APPLICATIONS. BUYER IS SOLELY RESPONSIBLE FOR PRODUCT SELECTION.</p> <p>*****</p> <p>WATER FLOW RATE NOTICE: LAVATORY FAUCETS WITH FLOW RATES OVER 0.5 GPM ARE NOT ALLOWED FOR 'PUBLIC USE' IN CALIFORNIA.</p>						

Looking for a more convenient way to pay your bill?

Log in to **Ferguson.com** and request access to Online Bill Pay.



TERMS: NET 10TH PROX	ORIGINAL INVOICE	TOTAL DUE	\$1,687.32
-----------------------------	-------------------------	------------------	-------------------

All past due amounts are subject to a service charge of 1.5% per month, or the maximum allowed by law, if lower. If Buyer fails to pay within terms, then in addition to other remedies, Buyer agrees to pay Seller all costs of collection, including reasonable attorney fees. Complete terms and conditions are available upon request or at <https://www.ferguson.com/content/website-info/terms-of-sale>, incorporated by reference. Seller may convert checks to ACH.

FERGUSON
WATERWORKS
27750 INDUSTRIAL BLVD
HAYWARD, CA 94545-3629

INVOICE NUMBER	TOTAL DUE	CUSTOMER	PAGE
1808846-1	\$1,571.54	454930	1 of 1

**PLEASE REFER TO INVOICE NUMBER WHEN
MAKING PAYMENT AND REMIT TO:**

Please contact with Questions: 510-786-3333

FERGUSON WATERWORKS #1423
PO BOX 740827
LOS ANGELES, CA 90074-0827

MASTER ACCOUNT NUMBER: 230316

SHIP TO:

JMB CONSTRUCTION INC
132 SOUTH MAPLE AVE
SLVWD - 2021 CIP PIPELINE
SOUTH SAN FRANCISCO, CA 94080-6320

COUNTER PICK UP
27750 INDUSTRIAL BLVD
HAYWARD, CA 94545-3629

SHIP WHSE.	SELL WHSE.	TAX CODE	CUSTOMER ORDER NUMBER	SALESMAN	JOB NAME	INVOICE DATE	BATCH
3300	3300	CA01HA	8X6 TAPN	GEW	SLVWD - 2021 CIP PIPELINE	08/23/23	IO 89910

ORDERED	SHIPPED	ITEM NUMBER	DESCRIPTION	UNIT PRICE	UM	AMOUNT
1		1 C263906201194009	6 FLG RW OL GATE VLV C509DI	1023.000	EA	1023.00
1		1 FELCRXU	8X6 FLG EPOX CONC RED	396.000	EA	396.00
INVOICE SUB-TOTAL						1419.00
TAX						152.54

LEAD LAW WARNING: IT IS ILLEGAL TO INSTALL PRODUCTS THAT ARE NOT "LEAD FREE" IN ACCORDANCE WITH US FEDERAL OR OTHER APPLICABLE LAW IN POTABLE WATER SYSTEMS ANTICIPATED FOR HUMAN CONSUMPTION. PRODUCTS WITH *NP IN THE DESCRIPTION ARE NOT LEAD FREE AND CAN ONLY BE INSTALLED IN NON-POTABLE APPLICATIONS. BUYER IS SOLELY RESPONSIBLE FOR PRODUCT SELECTION.

WATER FLOW RATE NOTICE: LAVATORY FAUCETS WITH FLOW RATES OVER 0.5 GPM ARE NOT ALLOWED FOR 'PUBLIC USE' IN CALIFORNIA.

Looking for a more convenient way to pay your bill?

Log in to **Ferguson.com** and request access to Online Bill Pay.



TERMS: NET 10TH PROX	ORIGINAL INVOICE	TOTAL DUE	\$1,571.54
-----------------------------	-------------------------	------------------	-------------------

All past due amounts are subject to a service charge of 1.5% per month, or the maximum allowed by law, if lower. If Buyer fails to pay within terms, then in addition to other remedies, Buyer agrees to pay Seller all costs of collection, including reasonable attorney fees. Complete terms and conditions are available upon request or at <https://www.ferguson.com/content/website-info/terms-of-sale>, incorporated by reference. Seller may convert checks to ACH.

FERGUSON®
WATERWORKS
27750 INDUSTRIAL BLVD
HAYWARD, CA 94545-3629

INVOICE NUMBER	TOTAL DUE	CUSTOMER	PAGE
1814236	\$220.18	454930	1 of 1

**PLEASE REFER TO INVOICE NUMBER WHEN
MAKING PAYMENT AND REMIT TO:**

FERGUSON WATERWORKS #1423
PO BOX 740827
LOS ANGELES, CA 90074-0827

Please contact with Questions: 510-786-3333

MASTER ACCOUNT NUMBER: 230316

SHIP TO:

JMB CONSTRUCTION INC
132 SOUTH MAPLE AVE
SLVWD - 2021 CIP PIPELINE
SOUTH SAN FRANCISCO, CA 94080-6320

COUNTER PICK UP
27750 INDUSTRIAL BLVD
HAYWARD, CA 94545-3629

3 No. 6" Gaskets = 3 * \$16.00 + Tax = \$53.16
3 No. Bolt Sets = 3 * \$39.54 + Tax = \$131.36

SHIP WHSE.	SELL WHSE.	TAX CODE	CUSTOMER ORDER NUMBER	SALESMAN	JOB NAME	INVOICE DATE	BATCH
3300	3300	CA01HA	6" BLIND FLG	GEW	SLVWD - 2021 CIP PIPELINE	09/14/23	IO 90191

ORDERED	SHIPPED	ITEM NUMBER	DESCRIPTION	UNIT PRICE	UM	AMOUNT
1	1	BFELU	6 CS BLND FLG EPOX	84.373	EA	84.37
1	1	UFTF06S	6 FLG TYTE 1/8 150# FF GSKT SBR	16.000	EA	16.00
1	1	FNWNBSS41U	6 304 SS 150# FLG NUT/BLT SET	39.540	EA	39.54
10	10	PSPWT210	2X100 10 MIL PIPE WRAP TAPE	5.890	EA	58.90
INVOICE SUB-TOTAL						198.81
TAX Alameda/Hayward						21.37

ITEM CODE	DESCRIPTION	NOTICE
FNWNBSS41U	6 304 SS 150# FLG NUT/BLT SET	<!> WARNING: Cancer and Reproductive Harm - www.P65Warnings.ca.gov
PSPWT210	2X100 10 MIL PIPE WRAP TAPE	<!> WARNING: Cancer and Reproductive Harm - www.P65Warnings.ca.gov

LEAD LAW WARNING: IT IS ILLEGAL TO INSTALL PRODUCTS THAT ARE NOT "LEAD FREE" IN ACCORDANCE WITH US FEDERAL OR OTHER APPLICABLE LAW IN POTABLE WATER SYSTEMS ANTICIPATED FOR HUMAN CONSUMPTION. PRODUCTS WITH *NP IN THE DESCRIPTION ARE NOT LEAD FREE AND CAN ONLY BE INSTALLED IN NON-POTABLE APPLICATIONS. BUYER IS SOLELY RESPONSIBLE FOR PRODUCT SELECTION.

WATER FLOW RATE NOTICE: LAVATORY FAUCETS WITH FLOW RATES OVER 0.5 GPM ARE NOT ALLOWED FOR 'PUBLIC USE' IN CALIFORNIA.

Looking for a more convenient way to pay your bill?

Log in to **Ferguson.com** and request access to Online Bill Pay.



TERMS: NET 10TH PROX	ORIGINAL INVOICE	TOTAL DUE	\$220.18
-----------------------------	-------------------------	------------------	-----------------

All past due amounts are subject to a service charge of 1.5% per month, or the maximum allowed by law, if lower. If Buyer fails to pay within terms, then in addition to other remedies, Buyer agrees to pay Seller all costs of collection, including reasonable attorney fees. Complete terms and conditions are available upon request or at <https://www.ferguson.com/content/website-info/terms-of-sale>, incorporated by reference. Seller may convert checks to ACH.

Tap Master, Inc

1647 Willow Pass Rd. # 136
Concord, CA 94520-2611
Ph: (925) 439-7975 Fax: (925) 432-1871
DIR# 1000000405

CA Lic # 697696
NV Lic # 0056402
WA Lic# TAPMAMI835DT
OR Lic# 239622
ID Reg# RCE-62535

INVOICE

DATE	INVOICE #
8/24/2023	0823-114

BILL TO

JMB Construction, Inc
Attention: Accounts Payable
132 South Maple Ave
So San Francisco, CA 94080

P.O. NO.	TERMS	DUE DATE
938	Net 30	9/23/2023

DESCRIPTION	AMOUNT
<p>LOCATION: 111 BROOKSIDE DRIVE - BOULDER CREEK CA</p> <p>(2) 6" HOT TAPS ON 8" ACP DOMESTIC COLD WATER LINES - TEST & TAP ONLY</p> <p>INCLUDES THE FOLLOWING ON STRAIGHT TIME: LABOR, TRUCK, EQUIPMENT 125# IMMEDIATE PRESSURE TESTS GENERATOR COUPONS RETRIEVED</p>	1,795.00
<p>WE NOW ACCEPT VISA, MASTERCARD & AMEX</p>	<p>Total \$1,795.00</p>

Tap Master, Inc does not agree to any retentions being held from the amount due. We can now accept ACH payments.
Past due accounts will be charged a finance charge at the periodic rate of 1-1/2% per month which is an annual percentage rate of 18% or a periodic rate not to exceed maximum rate allowed by state law.



P.O. Box 50001
Watsonville, CA 95077-5001
(831) 768-2000

Customer: 40067

Invoice No: 2111971
Invoice Date: 08/26/2023
Job No:
Order No: 2110478
Job PO No: TBD
Job Name: SLVWD CIP Pipeline
Job Street: 205 Brookside Dr Boulder Creek
Job City: Boulder Creek

JMB Construction*PO Req.**
132 South Maple Avenue
South San Francisco, CA 94080

9 YDS of Slurry = \$ 1,358.45
2 YDS of Slurry = \$ 301.88

Concrete

Product	Qty	Product Price	Amount	Freight Price	Freight Amount	Additional Charges	Tax Amount	Total
X09013 Mixer Driver Overtime (Min)	122.00 MN	3.00	366.00				9.00% 32.94	398.94
Totals for Ticket 423398			1,571.00	0.00	45.00		141.39	1,757.39
Date: 08/21/2023 Ticket: 423399 Location: Santa Cruz Concrete								
002200SC 2.0 SK CDF / CLSM SC SAND	9.00 Cu Yd	130.00	1,170.00			45.00	9.00% 105.30	1,320.30
000FSC Fuel Surcharge- Concrete	1.00 EA	0.00	0.00				9.00% 0.00	0.00
00ERFC Environmental Recovery Fee Concrete	1.00 EA	35.00	35.00				9.00% 3.15	38.15
X09013 Mixer Driver Overtime (Min)	147.00 MN	3.00	441.00				9.00% 39.69	480.69
Totals for Ticket 423399			1,646.00	0.00	45.00		148.14	1,839.14
Date: 08/21/2023 Ticket: 423400 Location: Santa Cruz Concrete								
002200SC 2.0 SK CDF / CLSM SC SAND	9.00 Cu Yd	130.00	1,170.00			45.00	9.00% 105.30	1,320.30
000FSC Fuel Surcharge- Concrete	1.00 EA	0.00	0.00				9.00% 0.00	0.00
00ERFC Environmental Recovery Fee Concrete	1.00 EA	35.00	35.00				9.00% 3.15	38.15
X09013 Mixer Driver Overtime (Min)	187.00 MN	3.00	561.00				9.00% 50.49	611.49
Totals for Ticket 423400			1,766.00	0.00	45.00		158.94	1,969.94
Date: 08/24/2023 Ticket: 423457 Location: Santa Cruz Concrete								
002200SC 2.0 SK CDF / CLSM SC SAND	9.00 Cu Yd	130.00	1,170.00			45.00	9.00% 105.30	1,320.30
000FSC FUEL SURCHARGE- CONCRETE	1.00 EA	0.00	0.00				9.00% 0.00	0.00
00ERFC ENVIRONMENTAL RECOVERY FEE	1.00 EA	35.00	35.00				9.00% 3.15	38.15
Totals for Ticket 423457			1,205.00	0.00	45.00		108.45	1,358.45
Date: 08/24/2023 Ticket: 423463 Location: Santa Cruz Concrete								
002200SC 2.0 SK CDF / CLSM SC SAND	9.00 Cu Yd	130.00	1,170.00			45.00	9.00% 105.30	1,320.30

INVOICE



PLEASE MAIL REMITTANCE TO:

Granite Construction Company
PO Box 742478
Los Angeles, CA 90074-2478

INVOICE DATE: 8/25/2023

Bill To:

JMB CONSTRUCTION INC
132 SOUTH MAPLE AVENUE
SOUTH SAN FRANCISCO CA 94080-6302
MGOAN@JMBCONSTRUCTION.COM

ORDER NO.	CUSTOMER NO.	PLANT	INVOICE NO.
295439	294825	FELTON A.C PLANT 201815 100321	2546905
ORIGINAL INVOICE #		JOB ADDRESS	DATE OF SALE
		SLVWD -CIP PIPELINE -BEN LOMOND 9500 BROOKSIDE AVENUE BEN LOMOND CA 95005	8/25/2023
			PO #
			938

A LATE FEE OF 1.5% PER MONTH (18% PER ANNUM) WILL BE APPLIED ON PAST DUE BALANCES

A CREDIT CARD FEE OF 2.3% WILL BE APPLIED TO ALL CREDIT CARD PAYMENTS MADE MORE THAN 10 BUSINESS DAYS AFTER THE INVOICE DATE ABOVE

TICKET NUMBER	TICKET DATE	MATERIAL DESCRIPTION	QTY	UNIT PRICE	EXTENDED AMOUNT	FOB	TAX RATE AREA
31626633	8/25/2023	1056 - 1/2"HMA64-10R15	6.340 TN	98.000	\$621.32	P	V050870000
		TOTAL: 1056 - 1/2"HMA64-10R15	6.3400 TN		\$621.32		
31626636	8/25/2023	1057 - 1/2"HMA64-10R15LAS	12.900 TN	98.000	\$1,264.20	P	V050870000
		TOTAL: 1057 - 1/2"HMA64-10R15LAS	12.9000 TN		\$1,264.20		
31626607	8/25/2023	1768 - #4WASHEDSAND C	5.970 TN	25.000	\$149.25	P	V050870000
31626621	8/25/2023	1768 - #4WASHEDSAND C	5.850 TN	25.000	\$146.25	P	V050870000
		TOTAL: 1768 - #4WASHEDSAND C	11.8200 TN		\$295.50		

1 Ton of AC = 1 * \$98.00 + Tax = \$106.82

TERMS: A/R Net 30 Days

The prevailing party shall be entitled to reasonable attorney's fees and costs in any action to collect the amounts due hereunder.
Note: if haul charges are indicated separately above, then the title passage of materials is at the plant, with delivery provided for customers.
For any question regarding this billing, please call (831)768-4002.

TOTAL FREIGHT	.00
MATERIAL	2,181.02
FEES	.00
SALES TAX	196.29

FOB: P=PLANT J=JOB

FOR OFFICIAL USE ONLY

Thank You for your business.

WARNING: THIS PRODUCT CONTAINS A CHEMICAL KNOWN TO THE STATE OF CALIFORNIA TO CAUSE CANCER, BIRTH DEFECTS OR OTHER REPRODUCTIVE HARM. MSDS SHEETS AVAILABLE AT WWW.GRANITECONSTRUCTION.COM/MSDS OR BY CONTACTING YOUR LOCAL OFFICE.

INVOICE TOTAL

\$2,377.31

INVOICE



PLEASE MAIL REMITTANCE TO:

Granite Construction Company
PO Box 742478
Los Angeles, CA 90074-2478

INVOICE DATE: 8/23/2023

ORDER NO.	CUSTOMER NO.	PLANT	INVOICE NO.
295439	294825	FELTON A.C PLANT 201815 100321	2544757
ORIGINAL INVOICE #		JOB ADDRESS	DATE OF SALE
		SLVWD -CIP PIPELINE -BEN LOMOND 9500 BROOKSIDE AVENUE BEN LOMOND CA 95005	8/23/2023
			PO #
			938

Bill To:

JMB CONSTRUCTION INC
132 SOUTH MAPLE AVENUE
SOUTH SAN FRANCISCO CA 94080-6302
MGOAN@JMBCONSTRUCTION.COM

A LATE FEE OF 1.5% PER MONTH (18% PER ANNUM) WILL BE APPLIED ON PAST DUE BALANCES

A CREDIT CARD FEE OF 2.3% WILL BE APPLIED TO ALL CREDIT CARD PAYMENTS MADE MORE THAN 10 BUSINESS DAYS AFTER THE INVOICE DATE ABOVE

TICKET NUMBER	TICKET DATE	MATERIAL DESCRIPTION	QTY	UNIT PRICE	EXTENDED AMOUNT	FOB	TAX RATE AREA
31626443	8/23/2023	1057 - 1/2"HMA64-10R15LAS	5.900	TN 98.000	\$578.20	P	V050870000
31626444	8/23/2023	1057 - 1/2"HMA64-10R15LAS	11.760	TN 98.000	\$1,152.48	P	V050870000
		TOTAL: 1057 - 1/2"HMA64-10R15LAS	17.6600	TN	\$1,730.68		
31626352	8/23/2023	1705 - 3/8" CMASC250	3.000	TN 130.000	\$390.00	P	V050870000
		TOTAL: 1705 - 3/8" CMASC250	3.0000	TN	\$390.00		
31626327	8/23/2023	1768 - #4WASHEDSAND C	11.760	TN 25.000	\$294.00	P	V050870000
31626328	8/23/2023	1768 - #4WASHEDSAND C	6.000	TN 25.000	\$150.00	P	V050870000
		TOTAL: 1768 - #4WASHEDSAND C	17.7600	TN	\$444.00		

2 Ton of Sand = 2 * \$25.00 + Tax = \$54.50

TERMS: A/R Net 30 Days The prevailing party shall be entitled to reasonable attorney's fees and costs in any action to collect the amounts due hereunder. Note: if haul charges are indicated separately above, then the title passage of materials is at the plant, with delivery provided for customers. For any question regarding this billing, please call (831)768-4002.	TOTAL FREIGHT .00 MATERIAL 2,564.68 FEES .00 SALES TAX 230.82
	INVOICE TOTAL
FOB: P=PLANT J=JOB Thank You for your business. WARNING: THIS PRODUCT CONTAINS A CHEMICAL KNOWN TO THE STATE OF CALIFORNIA TO CAUSE CANCER, BIRTH DEFECTS OR OTHER REPRODUCTIVE HARM. MSDS SHEETS AVAILABLE AT WWW.GRANITECONSTRUCTION.COM/MSDS OR BY CONTACTING YOUR LOCAL OFFICE.	\$2,795.50

RFI RECORD

RFI NO: 007

CONTRACT NO: SLVWD Contract #22/23-03
PROJECT: 2021 CIP Pipeline Project
CONTRACTOR: JMB Construction, Inc.
SUBJECT: 8" DIP Main Connections CA-9
SUBMITTAL #: N/A **DWG. NO:** N/A
PAGE NO: N/A **SUBCONTRACTOR:** N/A

CITY USE ONLY	
Receipt Date:	_____
Directed To:	_____
Transfer Date:	_____
Returned Date:	_____
Date Returned to Contractor:	_____

PRIORITY: ROUTINE URGENT PLEASE EXPEDITE

INFORMATION/CLARIFICATION REQUIRED:

Contractor herein submits the following RFI regarding the tie-in connection points on CA-9 for the new 8" Ductile Iron Water Main on Brookside Drive & Juanita Woods Road;

The existing Water Main on CA-9 is Asbestos (8" Dia.), which has been confirmed by JMB Construction, Inc. following recent potholing activities.

Contractor is requesting direction and/or a tie-in connection detail for this application.

08/10/2023
 Date

Adrian Power
 Project Manager

RESPONSE/REPLY:

RFI #7.0

SANDIS RESPONSE (2023-08-15):

Contractor to hot tap existing 8" ACP main with 8"x6" tapping sleeve. Attach 6" gate valve to a tapping sleeve followed by 6"x8" reducer. Connect proposed 8" DIP main to reducing fitting.

See markup below for additional information.

CHRISTOPHER SMALL - SANDIS

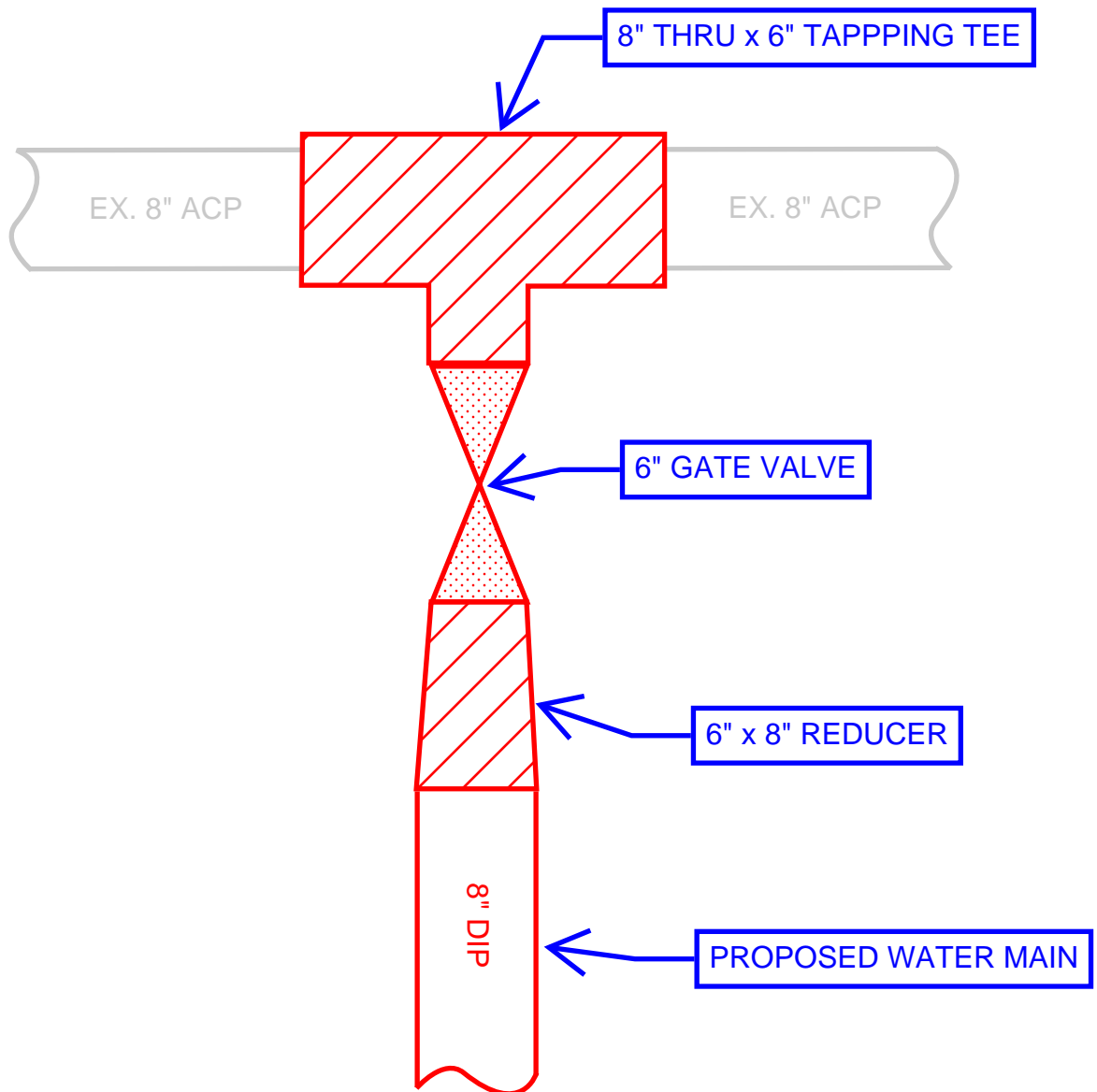

MEMO

DATE: April 4, 2024
TO: Board of Directors, San Lorenzo Valley Water District
FROM: Brian Frus, Interim General Manager
SUBJECT: Contract Change Order 4 - Alta Via Pipeline Replacement Project

WRITTEN BY: Joel Scianna, Assistant Engineer
PRESENTED BY: Garrett Roffe, Engineering Manager

STAFF RECOMMENDATION

That the Board authorizes the Interim General Manager to approve the attached Contract Change Order 4 for payment to Anderson Pacific Engineering Construction, Inc. as part of the District's Alta Via Pipeline Replacement project.

RECOMMENDED MOTION

The Board authorizes the Interim General Manager to approve Contract Change Order 4 for payment to Anderson Pacific Engineering Construction, Inc. for the Alta Via Pipeline Replacement Project in the sum of \$205,900 increasing the not to exceed contract amount from \$2,569,797 to \$2,775,879.

BACKGROUND

The Alta Via Neighborhood in Brookdale (including Alta Via Drive, Monan Way, and Prospect Ave) was damaged by the 2020 CZU fires, destroying above ground water mains in the area as well as several homes. The District's currently ongoing project includes installation of a permanent pipeline beneath the roadway, which will replace a temporary solution that has been in place since 2020.

CCO 04 - Monan Way Retaining Wall

Prior to the start of work in May 2023, Anderson Pacific Engineering Construction (APEC) submitted a request for information regarding a significant slope failure and roadway settling was found along Monan Way. These conditions occurred after the plans were created and were likely the result of the January/February 2023 storms, as well as a failed culvert nearby. A temporary bridge structure of steel plates and beams was constructed for use during construction, but is not a permanent solution.

The Geotechnical Engineer on the project, Haro, Kasunich and Associates, prepared plans for a soldier pile retaining wall to correct the failing roadway, which would protect both the District water main and the access road. (See Attachment 1). Since the last Board action, District staff have acquired quotes from three entities: the Project's contractor, APEC, along with two other construction companies. Given that all three quotes were similar (within 12% of each other), substantial cost reductions were not achievable. Despite APEC's quote being the highest among the three, it is

recommended to move forward with APEC's quote as they are already under contract, mobilized in the area and able to start work at the earliest opportunity.

APEC's quote for the retaining wall installation totals \$205,900 or 10% of the original contract amount.

ENVIRONMENTAL REQUIREMENTS

Pursuant to Title 14, the California Code of Regulations, Section 15301 of the California Environmental Quality Act ("CEQA") guidelines, the proposed action by the District results in a minor alteration of existing public or private structures that will result in negligible or no expansion of use.

PRIOR COMMITTEE ACTION

Change Orders 1, 2, 3, 5, 6, 7, and 9 have already been approved by the Board, totaling an additional \$160,162 above the original \$2,107,470 contract amount. Change Order 08 for Relocation of Water Main within Hwy 9 in accordance with Caltrans Project 05-1G950 has also been approved by the Board though funded through a different Purchase Order, and totals \$302,347.

FISCAL IMPACT

The amount of the original contract, change orders to date and the new change order requested in this memo are summarized in the table below.

Summary Table	
Original Contract	\$2,107,470
Approved Change Orders to Date *	\$462,509
New Change Order (CCO 4)	\$205,900
Total Contract with Change Orders	\$2,775,879
Amount over Contract	\$668,409
Percent Difference	32%

The total cost of the new change order to APEC is \$205,900 which brings the total contract change orders to \$668,409. Based on current year-to-date expenses, there are sufficient funds in the project budget to cover the proposed increase. Thus, no budget amendment is proposed.

ATTACHMENTS

1. Monan Way Retaining Wall Plans (HKA)
2. Contract Change Order 4

SOLDIER PILE RETAINING WALL AND ROADWAY IMPROVEMENT

ALTA VIA DRIVE MAIN REPLACEMENT PROJECT MONAN WAY BOULDER CREEK, CALIFORNIA

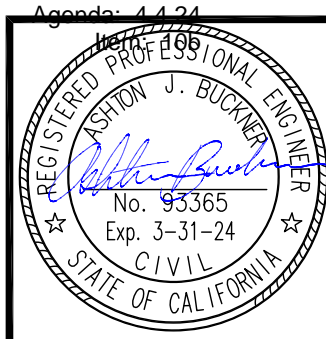

DATE	REVISION	BY

HARO, KASUNICH & ASSOCIATES
 GEOTECHNICAL AND COASTAL ENGINEERS
 116 EAST LAKE AVENUE, WATSONVILLE, CALIFORNIA 95076
 (831) 722 4175 PHONE AND (831) 722-3202 FAX

TITLE SHEET
 ALTA VIA DRIVE MAIN REPLACEMENT PROJECT
 MONAN WAY
 BOULDER CREEK, CALIFORNIA

PROJECT:	SC12326
DATE:	8/10/23
DESIGN:	TA + AB
DRAWN:	TA
SCALE:	AS SHOWN

C1

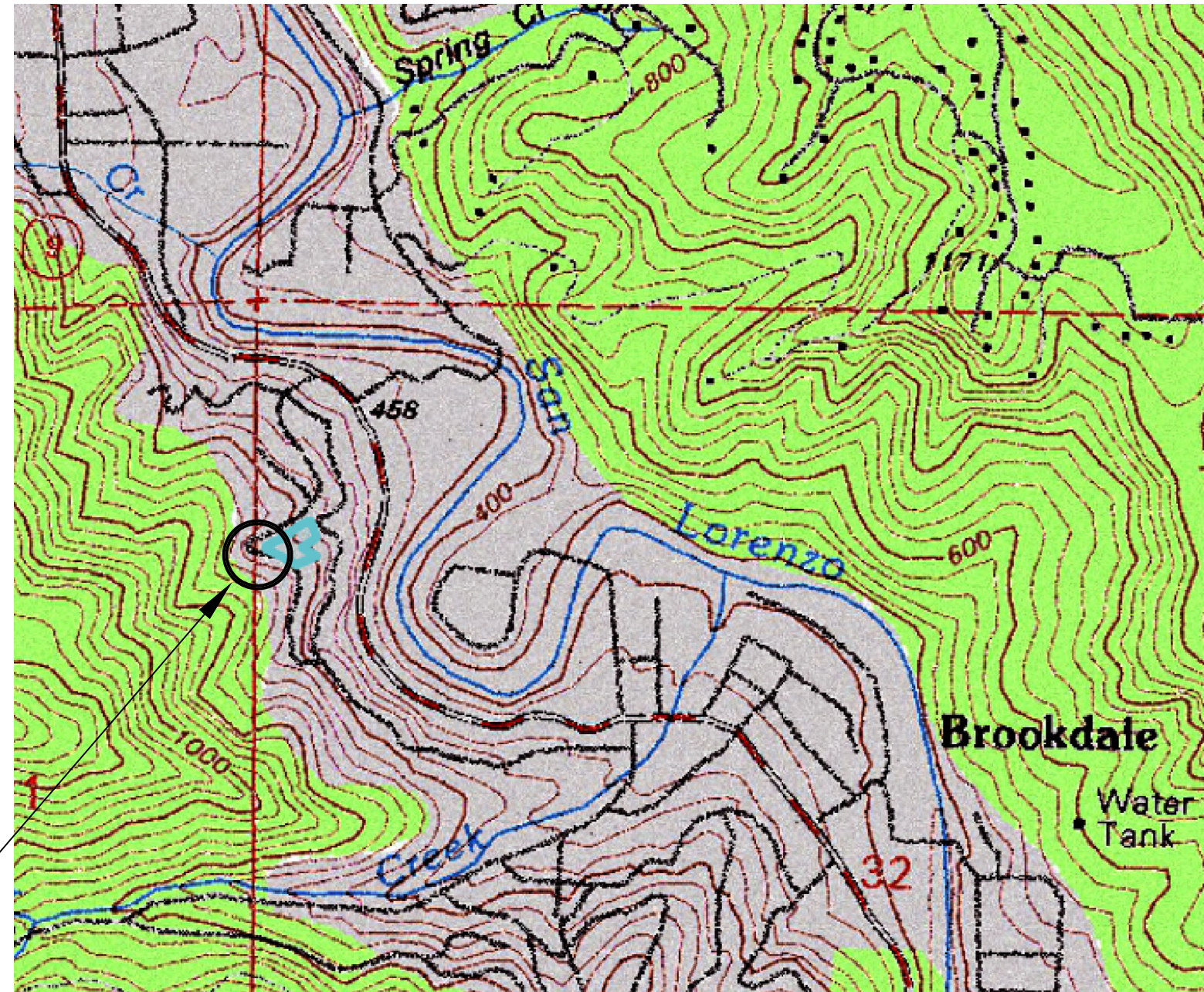

VICINITY MAP
N.T.S. (USGS)

PROJECT LOCATION



REGIONAL MAP
N.T.S. (GOOGLE)

PROJECT LOCATION

SHEET INDEX

- C1 TITLE SHEET
- C2 SITE RETAINING WALL PLAN
- C3 ROAD PROFILE AND CROSS SECTIONS
- C4 NOTES

GENERAL NOTES

1. ELEVATION DATUM: SANDIS SURVEY MAP
BASIS OF BEARINGS: SANDIS SURVEY MAP
2. CROSS SECTIONS AND ROAD PROFILE SURVEYED BY HARO, KASUNICH AND ASSOCIATES, INC.
3. GEOTECHNICAL REPORT AND CIVIL PLANS/DESIGNS PREPARED BY:
HARO, KASUNICH AND ASSOCIATES, INC.
116 EAST LAKE AVE.
WATSONVILLE, CA 95076
PROJECT NO.: SC12326
4. OWNER:
SAN LORENZO VALLEY WATER DISTRICT
13060 HIGHWAY 9
BOULDER CREEK, CALIFORNIA 95006
5. ALL CONSTRUCTION AND MATERIALS SHALL CONFORM TO THE 2022 EDITION OF THE STATE OF CALIFORNIA STANDARD SPECIFICATIONS PLANS, ISSUED BY THE DEPARTMENT OF TRANSPORTATION.
6. REFER TO OUR 10-AUGUST-2023 GEOTECHNICAL REPORT INVESTIGATION AND RECOMMENDATIONS FOR ADDITIONAL INFORMATION.

ABBREVIATIONS

AVG.	AVERAGE
CC	CONCRETE
CY	CUBIC YARDS
DIA.	DIAMETER
E	EXISTING
EG	EXISTING GROUND
ELEV.	ELEVATION
FG	FINISHED GRADE
FT	FEET
INV	INVERT
IN	INCH
MIN.	MINIMUM
N	NEW
NTS	NOT TO SCALE
O.C.	ON CENTER
SF	SQUARE FOOT
T	TREE
T.B.D.	TO BE DETERMINED
TRW	TOP OF RETAINING WALL
TYP.	TYPICAL

PROJECT DESCRIPTION

THESE DRAWINGS PROVIDE DETAILS FOR THE CONSTRUCTION OF A SOLDIER PILE RETAINING WALL AND ROADWAY IMPROVEMENTS REQUIRED TO MAINTAIN ACCESS ON MONAN WAY AND FACILITATE CONSTRUCTION OF THE PROPOSED ALTA VIA DRIVE WATER MAIN REPLACEMENT IN BOULDER CREEK. THE NEW APPROXIMATELY 46-FOOT LONG RETAINING WALL WILL CONSIST OF STEEL I-BEAMS, REINFORCED CONCRETE PIERS, SOLDIER PILES WITH WOOD LAGGING, AND DRAINAGE MATERIAL.

SECTION AND DETAIL CONVENTION

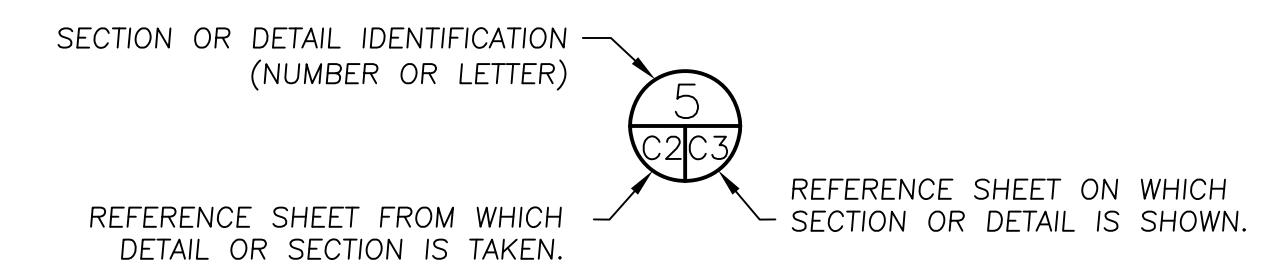



DATE	REVISION	BY

HARO, KASUNICH & ASSOCIATES
 GEOTECHNICAL AND COASTAL ENGINEERS
 116 EAST LAKE AVENUE, WATSONVILLE, CALIFORNIA 95076
 (831) 722 4175 PHONE AND (831) 722-3202 FAX

RETAINING WALL SITE PLAN
 ALTA VIA DRIVE MAIN REPLACEMENT PROJECT
 MONAN WAY
 BOULDER CREEK, CALIFORNIA

PROJECT:	SCI2326
DATE:	8/10/23
DESIGN:	TA + AB
DRAWN:	TA
SCALE:	1" = 10'

C2

NOTES:

GENERAL NOTES

- ALL CONSTRUCTION SHALL COMPLY WITH THE REQUIREMENTS OF THE GEOTECHNICAL REPORT UPDATE DATED, 18 AUGUST 2023, PREPARED BY HARO, KASUNICH AND ASSOCIATES, INC. (HKA) PROJECT NO. SC12326, AND THE REQUIREMENTS OF THE COUNTY OF SANTA CRUZ.
- THE NEW RETAINING WALLS SHOULD BE SUPPORTED BY SOLDIER PILES EMBEDDED INTO WEATHERED MONTEREY FORMATION WITH 24-30" DIAMETER CONCRETE FILLED SHAFTS.
- EXISTING UNDOCUMENTED FILL SHOULD BE REMOVED AND REPLACED WITH ENGINEERED FILL.
- DETERMINING THE EXISTENCE, LOCATION, AND DEPTH OF UNDERGROUND UTILITIES IS THE RESPONSIBILITY OF THE CONTRACTOR. THIS SHOULD BE DONE PRIOR TO COMMENCEMENT OF WORK. THE ENGINEER SHOULD BE NOTIFIED IF ANY DISCREPANCIES OR CONFLICTS ARE ENCOUNTERED.
- ALL WORK SHALL CONFORM TO APPROVED SPECIFICATIONS PRESENTED HEREIN OR CONTAINED IN THE GEOTECHNICAL REPORT OF 18 AUGUST 2023.
- SHAFTS SHALL BE OBSERVED AND APPROVED BY THE SOIL ENGINEER PRIOR TO PLACEMENT OF SOLDIER PILES.
- HKA SHALL BE NOTIFIED AT LEAST (4) WORKING DAYS BEFORE BEGINNING WORK AT TELEPHONE NUMBER (831)722-4175, EXT. 104. HKA SHALL NOT BE RESPONSIBLE FOR WORK THAT HAS NOT BEEN OBSERVED AND DOCUMENTED BY HKA.
- THE CONTRACTOR SHALL OBTAIN INSPECTION OF ALL WORK BY THE CONTROLLING AGENCY.
- IF, DURING THE COURSE OF CONSTRUCTION, CULTURAL, ARCHAEOLOGICAL, HISTORICAL OR PALEONTOLOGIST RESOURCES ARE UNCOVERED AT THE SITE (SURFACE OR SUBSURFACE RESOURCES) WORK SHALL BE HALTED IMMEDIATELY WITHIN 50 METERS OF THE FIND UNTIL A QUALIFIED PROFESSIONAL ARCHAEOLOGIST CAN EVALUATE IT. SANTA CRUZ COUNTY - PLANNING AND A QUALIFIED ARCHAEOLOGIST (I.E., AN ARCHAEOLOGIST REGISTERED WITH THE REGISTER OF PROFESSIONAL ARCHAEOLOGISTS) SHALL BE IMMEDIATELY CONTACTED BY THE RESPONSIBLE INDIVIDUAL PRESENT ON-SITE. WHEN CONTACTED, THE PROJECT PLANNER AND THE ARCHAEOLOGIST SHALL IMMEDIATELY VISIT THE SITE TO DETERMINE THE EXTENT OF THE RESOURCES AND TO DEVELOP PROPER MITIGATION MEASURES REQUIRED FOR RECOVERY (PLANNING).
- IF DISCREPANCIES ARE DISCOVERED BETWEEN THE CONDITIONS EXISTING IN THE FIELD AND THE INFORMATION SHOWN ON THESE DRAWINGS, NOTIFY THE ENGINEER PRIOR TO PROCEEDING WITH CONSTRUCTION.
- PROTECT TREES ADJACENT TO PROJECT FROM POTENTIAL DAMAGE.
- IT SHALL BE THE RESPONSIBILITY OF THE CONTRACTOR TO BE FULLY INFORMED OF AND TO COMPLY WITH ALL LAWS, ORDINANCES, CODES, REQUIREMENTS AND STANDARDS WHICH IN ANY MANNER AFFECT THE COURSE OF CONSTRUCTION OF THIS PROJECT, THOSE ENGAGED OR EMPLOYED IN THE CONSTRUCTION AND THE MATERIALS USED IN THE CONSTRUCTION.
- ANY TESTS, INSPECTIONS, SPECIAL OR OTHERWISE, THAT ARE REQUIRED BY THE BUILDING CODES, LOCAL BUILDING DEPARTMENTS, OR THESE PLANS, SHALL BE DONE BY AN INDEPENDENT INSPECTION COMPANY. JOB SITE VISITS BY THE ENGINEER DO NOT CONSTITUTE AN OFFICIAL INSPECTION. IT IS THE CONTRACTOR'S RESPONSIBILITY TO ENSURE THAT THE REQUIRED TESTS AND INSPECTIONS ARE PERFORMED.
- THE CONTRACTOR SHALL BE RESPONSIBLE FOR DESIGN, PERMITTING, INSTALLATION, AND MAINTENANCE OF ANY AND ALL TRAFFIC CONTROL MEASURES DEEMED NECESSARY.
- THE CONTRACTOR SHALL BE RESPONSIBLE FOR GENERAL SAFETY DURING CONSTRUCTION. ALL WORK SHALL CONFORM TO PERTINENT SAFETY REGULATIONS AND CODES. THE CONTRACTOR SHALL BE SOLELY AND COMPLETELY RESPONSIBLE FOR FURNISHING, INSTALLING, AND MAINTAINING ALL WARNING SIGNS AND DEVICES NECESSARY TO SAFEGUARD THE GENERAL PUBLIC AND THE WORK, AND PROVIDE FOR THE PROPER AND SAFE ROUTING OF VEHICULAR AND PEDESTRIAN TRAFFIC DURING THE PERFORMANCE OF THE WORK.
- CONTRACTOR SHALL BE RESPONSIBLE FOR ALL CONSTRUCTION STAKING AND LAYOUT, UNLESS OTHERWISE SPECIFIED.
- THE CONTRACTOR SHALL BE RESPONSIBLE FOR THE PROTECTION AND PRESERVATION OF ALL SURVEY MONUMENTS OR PROPERTY CORNERS. DISTURBED MONUMENTS SHALL BE RESTORED BACK TO THEIR ORIGINAL LOCATION AND SHALL BE CERTIFIED BY A REGISTERED CIVIL ENGINEER OR LAND SURVEYOR AT THE SOLE EXPENSE OF THE CONTRACTOR.
- EXISTING UNDERGROUND UTILITY LOCATIONS:
 - CALL UNDERGROUND SERVICE ALERT (811) TO LOCATE ALL UNDERGROUND UTILITY LINES PRIOR TO COMMENCING CONSTRUCTION.
 - PRIOR TO BEGINNING WORK, CONTACT ALL UTILITIES COMPANIES WITH REGARD TO WORKING OVER, UNDER, OR AROUND EXISTING FACILITIES AND TO OBTAIN INFORMATION REGARDING RESTRICTIONS THAT ARE REQUIRED TO PREVENT DAMAGE TO THE FACILITIES.
 - THE CONTRACTOR IS SOLELY RESPONSIBLE FOR THE LOCATION AND/OR PROTECTION OF ALL EXISTING AND PROPOSED PIPING, UTILITIES, TRAFFIC SIGNAL EQUIPMENT (BOTH ABOVE GROUND AND BELOW GROUND), STRUCTURES, AND ALL OTHER EXISTING IMPROVEMENTS THROUGHOUT CONSTRUCTION.
 - PRIOR TO COMMENCING FABRICATION OR CONSTRUCTION, DISCOVER OR VERIFY THE ACTUAL DIMENSIONS, SIZES, MATERIALS, LOCATIONS, AND ELEVATIONS OF ALL EXISTING UTILITIES AND POTHOLES THOSE AREAS WHERE POTENTIAL CONFLICTS ARE LIKELY OR DATA IS OTHERWISE INCOMPLETE.
 - TAKE APPROPRIATE MEASURES TO PROTECT EXISTING UTILITIES DURING CONSTRUCTION OPERATIONS. CONTRACTOR IS SOLELY RESPONSIBLE FOR THE COST OF REPAIR/REPLACEMENT OF ANY EXISTING UTILITIES DAMAGED DURING CONSTRUCTION.
 - UPON LEARNING OF THE EXISTENCE AND/OR LOCATIONS OF ANY UNDERGROUND FACILITIES NOT SHOWN OR SHOWN INACCURATELY ON THE PLANS OR NOT PROPERLY MARKED BY THE UTILITY OWNER, IMMEDIATELY NOTIFY THE UTILITY OWNER AND THE CITY BY TELEPHONE AND IN WRITING.
 - UTILITY RELOCATIONS REQUIRED FOR THE CONSTRUCTION OF THE PROJECT FACILITIES WILL BE PERFORMED BY THE UTILITY COMPANY, UNLESS OTHERWISE NOTED.

DIMENSIONS

- DIMENSIONS UNLESS OTHERWISE SHOWN ARE TO THE CENTER OF COLUMNS AND BEAMS.
- CONTRACTOR SHALL VERIFY AND BE RESPONSIBLE FOR ALL DIMENSIONS AND CONDITIONS ON THE JOB SITE. PLEASE NOTIFY HKA OF ANY DIMENSION VARIATIONS PRIOR TO THE START OF CONSTRUCTION.

CONCRETE

- CONCRETE WORK SHALL CONFORM TO THE REQUIREMENTS OF ACI 318-11 "BUILDING CODE REQUIREMENTS FOR STRUCTURAL CONCRETE"
- ALL CONCRETE SHALL BE REGULAR WEIGHT HARD ROCK AND HAVE A MINIMUM 28 DAY COMPRESSIVE STRENGTH OF 2500 PSI. USE TYPE II CEMENT ASTM C150 MAX. AGGREGATE SIZE 3/4".
- DO NOT BACKFILL WALL UNTIL CONCRETE HAS REACHED IT'S STRENGTH, OTHERWISE USE FAST SETTING CONCRETE WITH ENGINEER'S APPROVAL.

LUMBER

- USE PRESSURE TREATED DOUGLAS FIR #2 TIMBER LAGGING (AWPA USE CATEGORY UC4B GROUND CONTACT HEAVY DUTY). SEE RETAINING WALL SCHEDULE FOR SIZE. PRESSURE TREATMENT TO CONFORM WITH CALTRANS SECTION 58-1.02 (AWPA STANDARD C14).
- SPACE LAGGING BOARDS VERTICALLY BY 1/4" TO ALLOW FOR DRAINAGE.

STEEL

- USE A50 (Fy=50KSI) STEEL.

GENERAL NOTES CONTINUED

- A PRECONSTRUCTION CONFERENCE IS REQUIRED.

GEOTECHNICAL DESIGN NOTES:

- EXISTING UNDOCUMENTED FILL SHOULD BE REMOVED AND REPLACED WITH ENGINEERED FILL. THE LIMITS OF UNDOCUMENTED FILL TO BE DETERMINED IN THE FIELD.

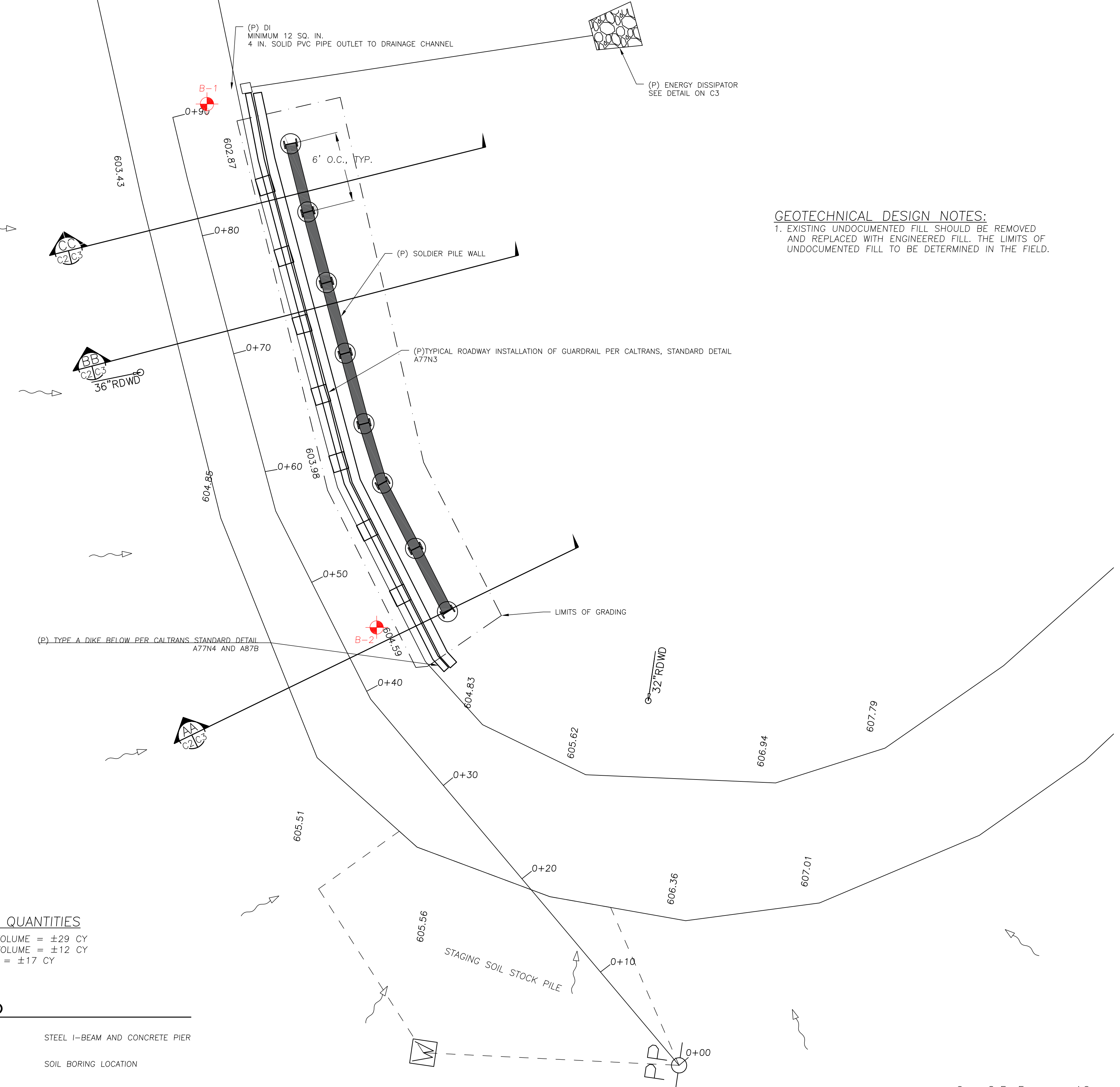

GRADING QUANTITIES
 TOTAL CUT VOLUME = ±29 CY
 TOTAL FILL VOLUME = ±12 CY
 NET VOLUME = ±17 CY

LEGEND

- STEEL I-BEAM AND CONCRETE PIER
- SOIL BORING LOCATION
- LIMITS OF GRADING
- FLOW LINES

SITE PLAN
 SCALE: 1" = 5'

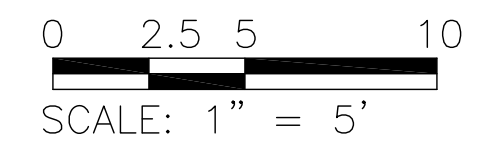

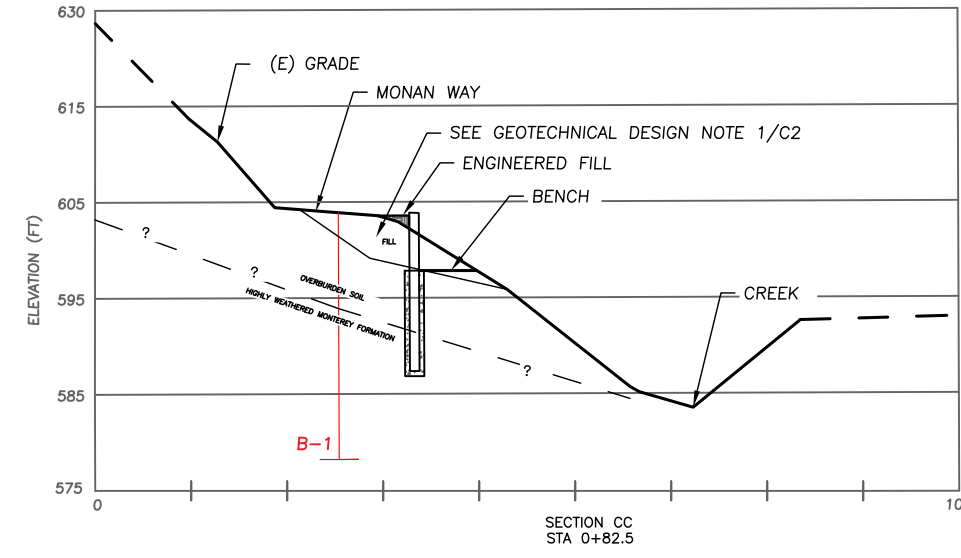
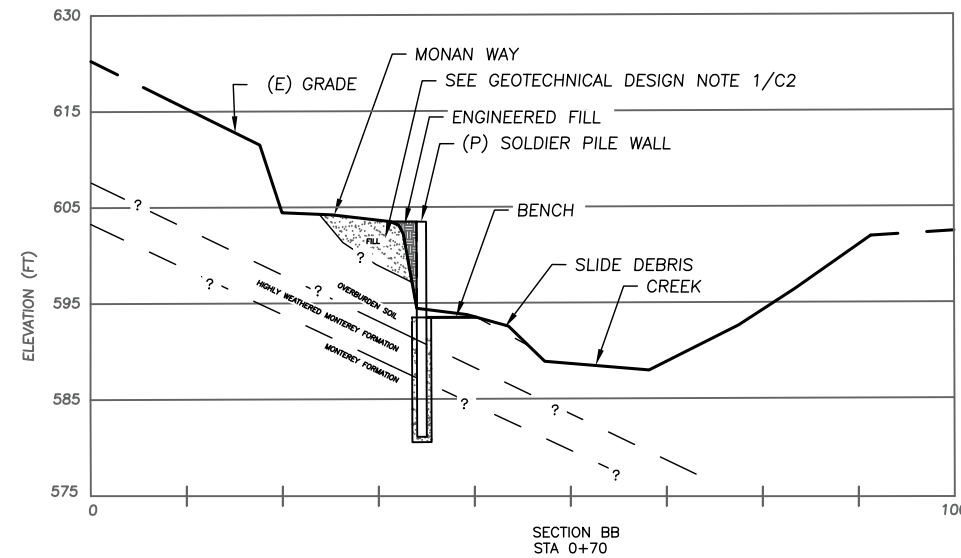
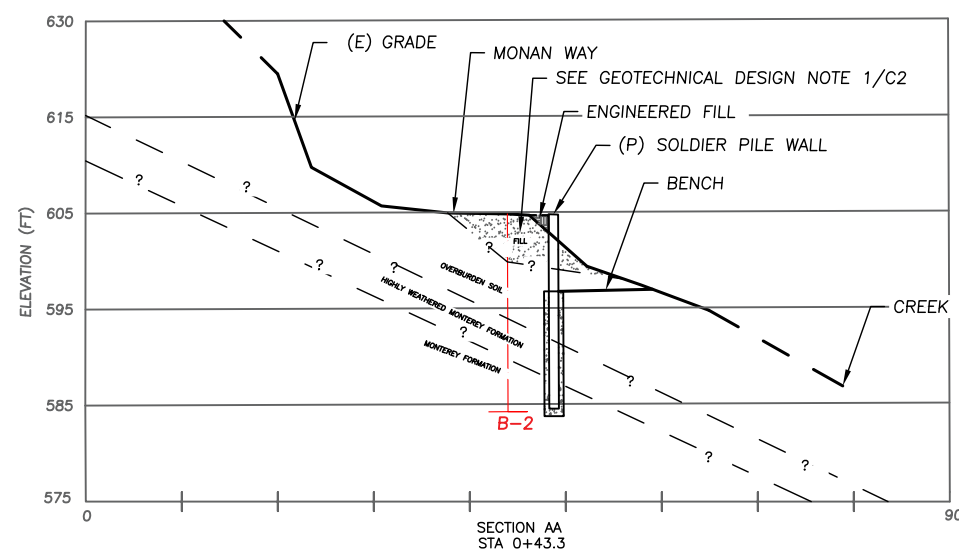

CROSS SECTIONS
SCALE: 1" = 20'

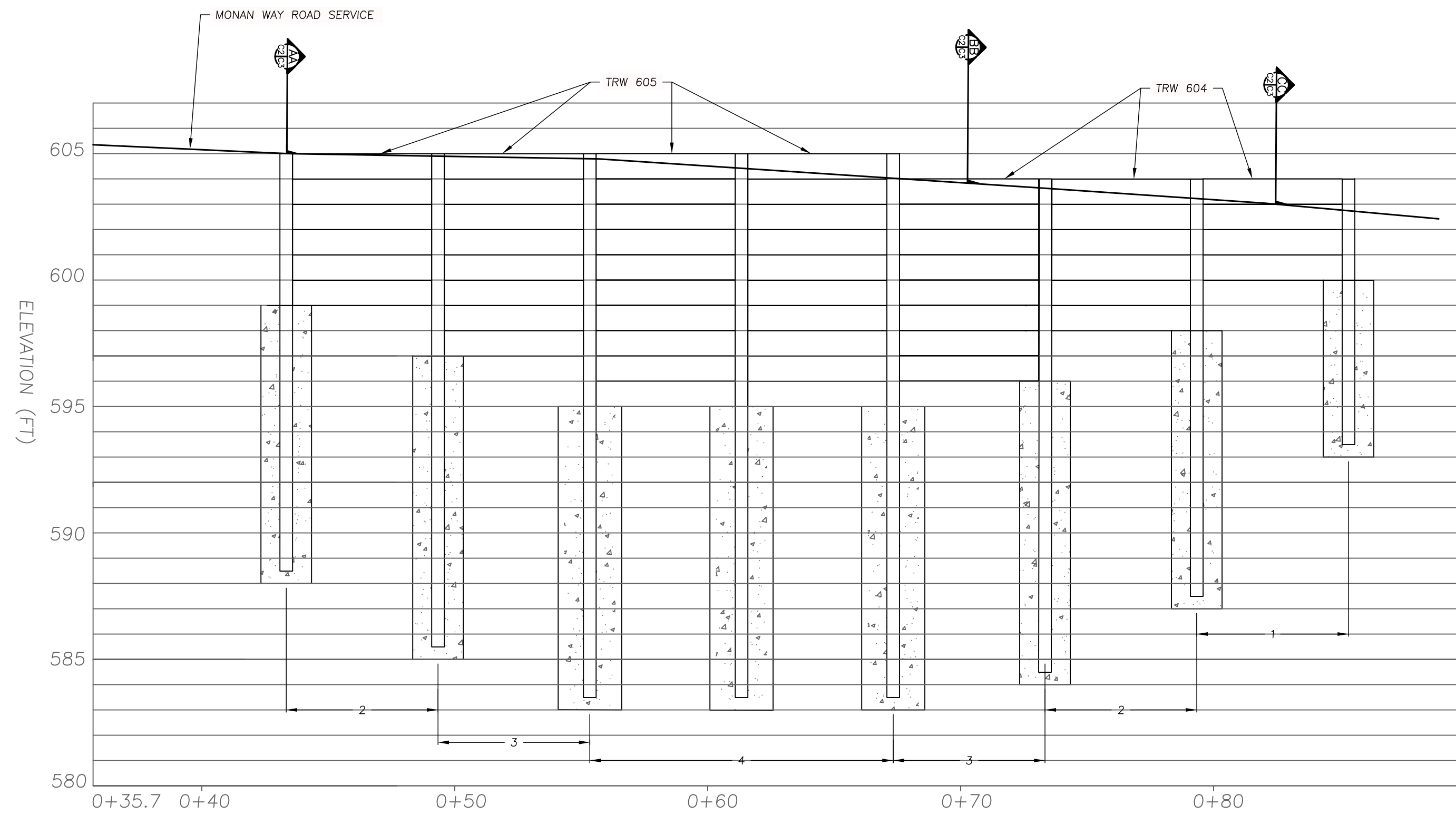
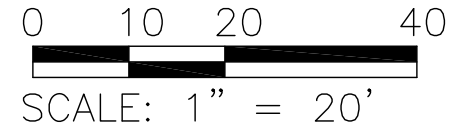

ROADWAY PROFILE
SCALE: 1" = 4'

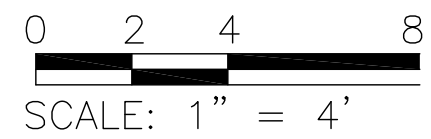

TYPICAL RETAINING WALL SCHEDULE

BAY	WALL HEIGHT (FT)	MAX. PIER SPACING (FT)	PIER DEPTH (FT)	DIAMETER (IN)	STEEL BEAM SHAPE ¹	WOOD LAGGING ^{2,3} (INCH)
1	4	6.0	7.0	24.0	W12x14	SEE SHEET C3
2	6	6.0	11.0	24.0	W12x16	
3	8	6.0	12.0	24.0	W14x26	
4	10	6.0	12.0	30.0	W18x40	

NOTES:
1) ASSUMES F_y = 50 ksi.
2) WOOD LAGGING SHOULD BE PRESSURE TREATED DOUGLAS FIR LARCH NO. 2. PRESSURE TREAT TO CONFORM WITH CALTRANS SECTION 58-1.02.
3) SEE SHEET C3.

TYPE A DIKE BELOW PER CALTRANS STANDARD DETAIL A77N4 AND A87B

BACKFILL WITH CLASS 1, TYPE A PERMEABLE MATERIAL COMPLYING WITH SECTION 68 OF CALTRANS STD. SPECIFICATIONS. CAP TOP OF BACKFILL WITH 12 INCHES OF ONSITE SOIL, HAND TAPPED.

4 INCH DIAMETER PERFORATED DRAIN PIPE (WITH PERFORATIONS DOWNWARD) INSTALLED WITHIN 4 INCHES OF BOTTOM OF GRANULAR BACKFILL.

EXCAVATED PIER. SEE RET. WALL SCHEDULE FOR DEPTH. 2500 PSI CONCRETE. SPACING PER PLAN (5FT MAX SPACING).

LAGGING SCHEDULE FOR ALL BAYS

ALL BAYS	
LAGGING DEPTH (FT)	LAGGING SIZE (IN)*
0-10	6x12
* NOMINAL	

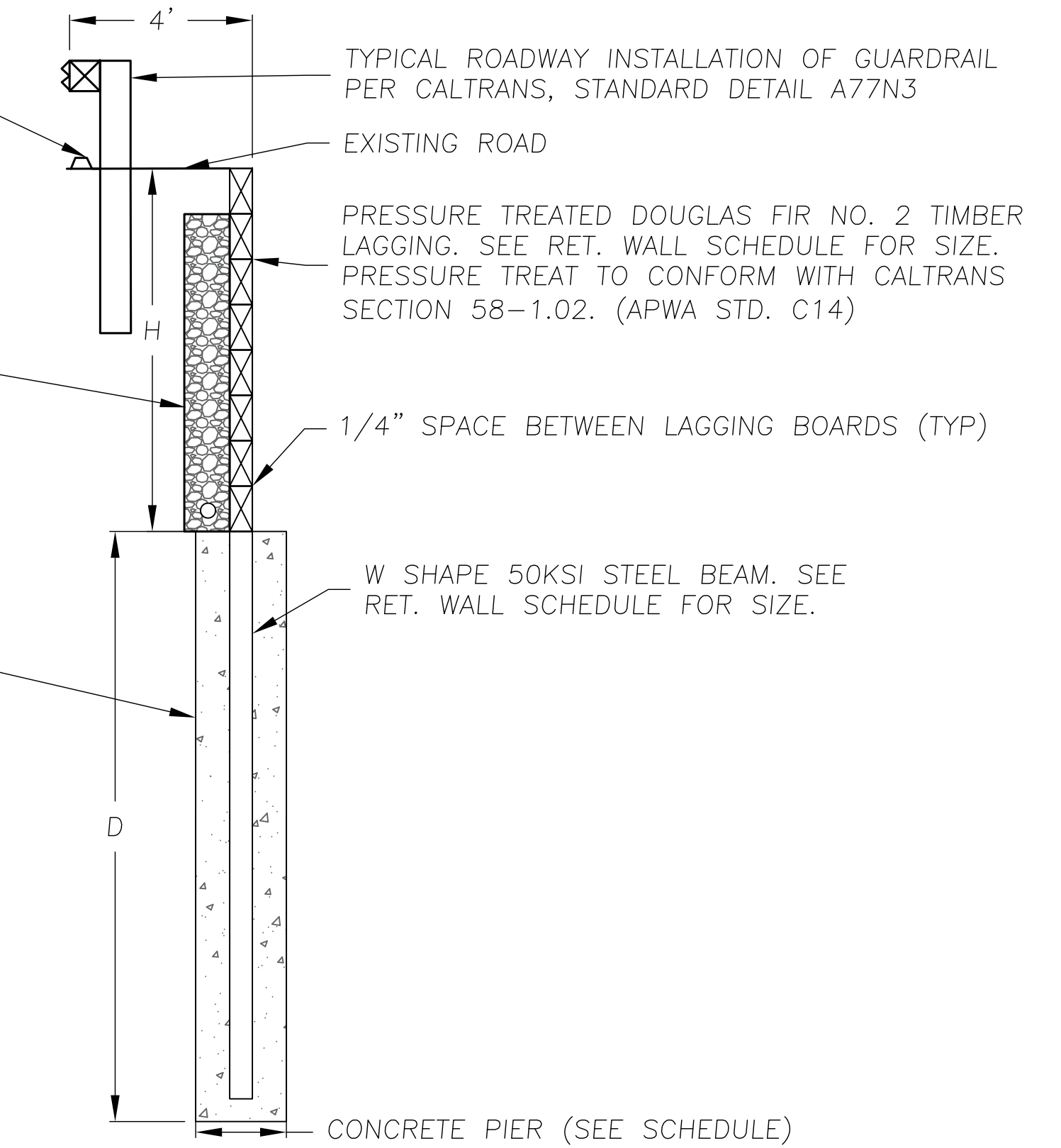

TYP. SOLDIER PILE SECTION
SCALE: 1" = 3'

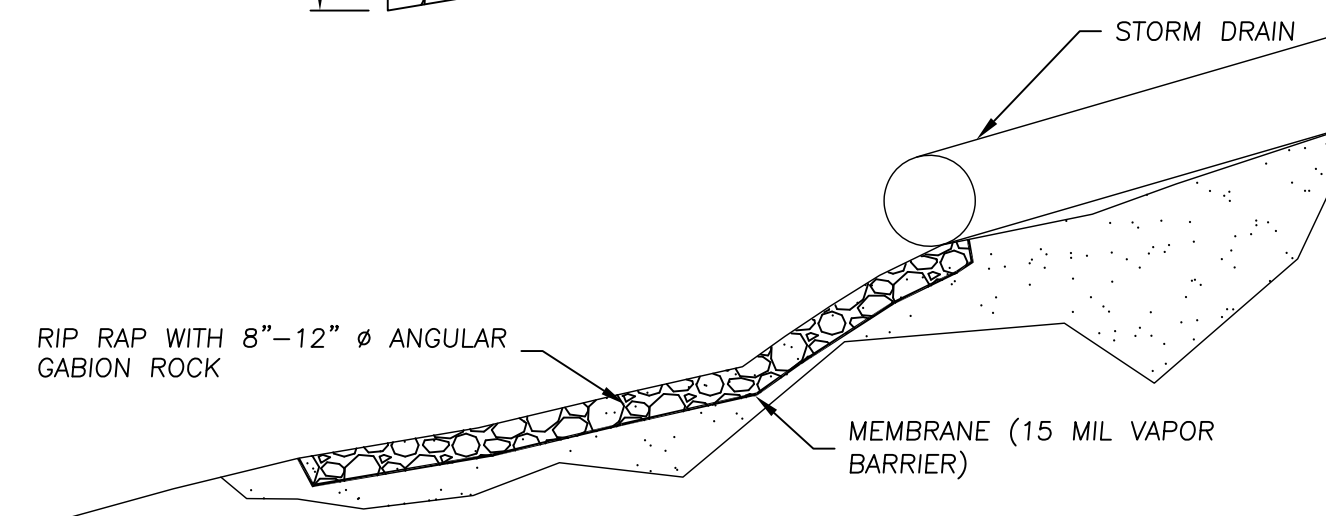
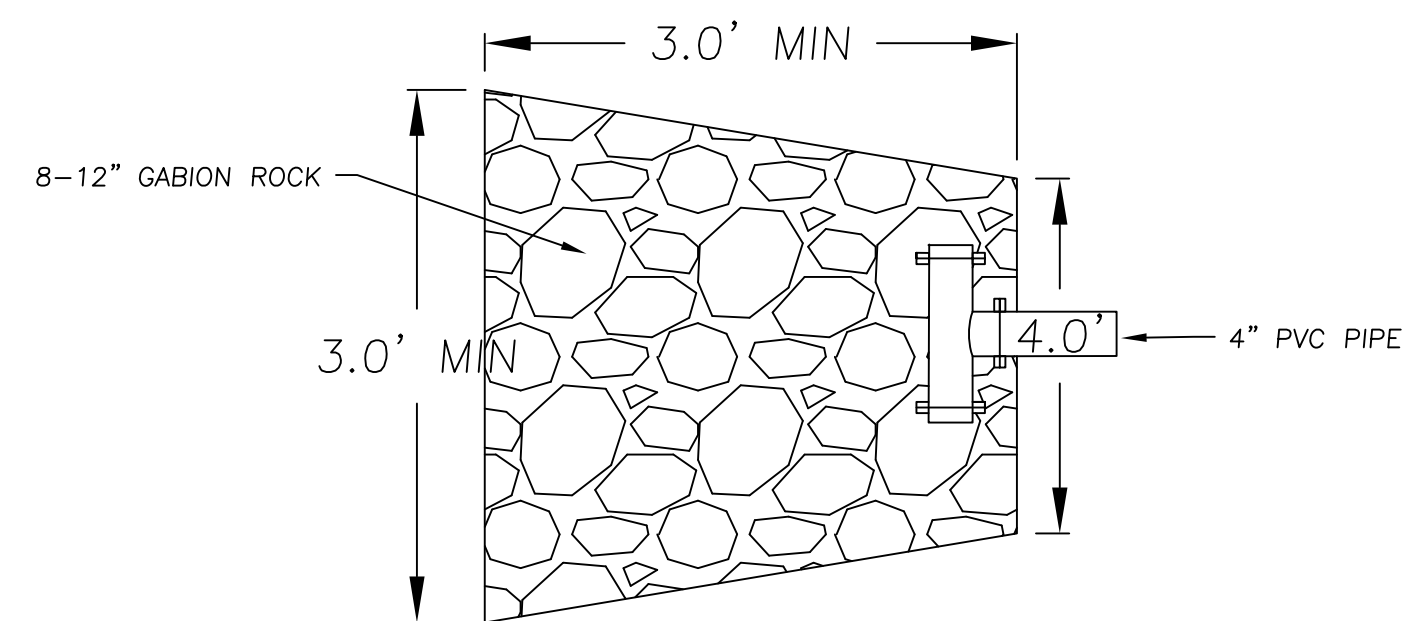

ENERGY DISSIPATOR DETAIL
SCALE: N.T.S.

BY	REVISION	DATE

HARO, KASUNICH & ASSOCIATES
GEOTECHNICAL AND COASTAL ENGINEERS
116 EAST LAKE AVENUE, WATSONVILLE, CALIFORNIA 95076
(831) 722-4175 PHONE AND (831) 722-3202 FAX

SOLDIER PILE WALL PROFILE AND CROSS SECTIONS
ALTA VIA DRIVE MAIN REPLACEMENT PROJECT
MONAN WAY
BOULDER CREEK, CALIFORNIA

PROJECT:	SC12326
DATE:	8/10/23
DESIGN:	TA + AB
DRAWN:	TA
SCALE:	AS SHOWN

C3





Alta Via Pipeline Replacement Project – Contract Change Order 4 (Monan Way Retaining Wall)

04/04/2024

Change Order No. 4

Contract No. 21/22-16

To: Anderson Pacific Engineering Construction, Inc.

This Change Order No. 4 for the San Lorenzo Valley Water District’s Alta Via Pipeline Replacement Project encompasses the following changes to Contract No. 21/22-16:

1. An Extra Cost adjustment encompassing costs for the proposed Retaining Wall along Monan Way, as shown in the Monan Way Retaining Wall Plans dated 10 Aug 2023.
2. This \$205,900.00 includes labor, materials, equipment, and payment to subcontractors.

Payment Adjustment at Agreed Lump Sum of \$205,900.00; Adjusted Contract Price is \$2,899,546.23.

By signing this change order all parties agree to the preceding changes to the plans, specifications, and contract documents.

Brian Frus, Interim General Manager
San Lorenzo Valley Water District

Date: _____

Michael P. Gossett, Project Manager
Anderson Pacific Engineering Construction, Inc.

Date: _____



October 24, 2023

San Lorenzo Valley Water District
13060 CA-9
Boulder Creek, CA 95006

Attn: Steve Yazalina, Sandis

Reference: **Alta Via Pipeline Replacement Project, Potential Change Order No. 4- Monan Way Retention Wall, Revision 1.**

Mr. Yazalina:

APEC is pleased to provide the following quotation for the proposed retaining wall on Monan Drive. Installation of the soldier pile and wood lagging retaining wall shall be constructed per drawings by Haro, Kasunich & Associates, dated August 10, 2023.

Additional information is requested for the following: 1) Please clarify at what depth the perforated 4" diameter PVC back drain is to be installed, as there are four different bay depths for concrete; 2) Confirming the steel soldier piles do not require coatings.

Exclusions: inspection and testing; all monitoring (including but not limited to vibration, sound and biological); permits; tree trimming/ removal; road subgrade repair/ replacement.

Monan Way Retaining Wall:

Labor:	\$21,879.00
Material:	\$29,835.00
Equipment:	\$9,945.00
Subcontractor:	\$144,241.00

TOTAL: \$205,900.00

If you have any questions, please do not hesitate to contact me.

Regards,

Michael P. Gossett

Michael P. Gossett
Project Manager

1370 Norman Avenue
Santa Clara, CA 95054
Lic. No. 245215

MEMO

DATE: April 4, 2024
TO: Board of Directors, San Lorenzo Valley Water District
FROM: Brian Frus, Interim General Manager
SUBJECT: Contract Change Orders 10 & 11 - Alta Via Pipeline Replacement Project

WRITTEN BY: Joel Scianna, Assistant Engineer
PRESENTED BY: Garrett Roffe, Engineering Manager

STAFF RECOMMENDATION

That the Board authorize the Interim General Manager to approve the attached Contract Change Orders 10 and 11 for payment to Anderson Pacific Engineering Construction, Inc. as part of the District's Alta Via Pipeline Replacement project.

RECOMMENDED MOTION

The Board:

I move that the Board authorize the Interim General Manager to approve Contract Change Orders 10 and 11 for payment to Anderson Pacific Engineering Construction, Inc. for the Alta Via Pipeline Replacement in the sum of \$123,667 increasing the not to exceed contract amount from \$2,569,979 to \$2,693,646.

BACKGROUND

The Alta Via Neighborhood in Brookdale (including Alta Via Drive, Monan Way, and Prospect Ave) was damaged by the 2020 CZU fires, destroying above ground water mains in the area as well as several homes. The District's currently ongoing project includes installation of a permanent pipeline beneath the roadway, which will replace the temporary fix that has been in place since 2020.

CCO 10 - Water Service Extensions

Contracted work on service connections between the water main and the customers' homes will typically stop at the water meter. This limit is reflected in the contract, however Rick Rogers, District Manager at the time, decided that this contract work should be extended to fully connect from the meter to the customer's home. A large number of meters needed to be relocated as the result of this project, some at significant distances from their previous meters, which was deemed an undue burden to place on the CZU-affected community.

This change order includes:

- Additional work to connect homes to their new meter locations
- Additional erosion control work at the cross country pipeline
- Emergency paving along Monan Way
- Tie-in work to connect to two existing 2" mains

The above work was negotiated to \$117,253.32.

CCO 11 - Steel Plate Rental for Temporary Bridge

Prior to the start of work in May 2023, Anderson Pacific Engineering Construction (APEC) submitted a request for information regarding a significant slope failure and roadway settling was found along Monan Way. These conditions occurred after the plans were created and were likely the result of the January/February 2023 storms, as well as a failed culvert nearby. A temporary bridge structure of steel plates and beams was constructed has been used during construction, but is not a permanent solution. This CCO covers rental fees incurred from November 2023 through January 2024.

These rental fees totaled to \$6,415.20.

ENVIRONMENTAL REQUIREMENTS

Pursuant to Title 14, the California Code of Regulations, Section 15301 of the California Environmental Quality Act (“CEQA”) guidelines, the proposed action by the District results in a minor alteration of existing public or private structures that will result in negligible or no expansion of use.

PRIOR COMMITTEE ACTION

Contract Change Order (CCO) 7 with Anderson Pacific Engineering Construction (APEC) for the Temporary Bridge Installation on Monan Way was brought to the Board of Directors on January 4, 2024.

FISCAL IMPACT

Item	Amount (\$)	Percent of Initial Bid
Initial Bid Amount	\$2,107,470	100%
CCO's approved to Date*	\$160,161.71	7.6%
CCO's 10 + 11	\$123,667.52	5.9%

*Excluding CCO 08 - Relocation of Water Main within Hwy 9 in Accordance to Caltrans Project 05-1G950, which will be funded through a different PO, and totals \$302,347.00

Based on current year-to-date expenses, there are sufficient funds in the project budget to cover the proposed increase. Thus, no budget amendment is proposed.

ATTACHMENTS

1. Contract Change Order 10
2. Contract Change Order 11



Alta Via Pipeline Replacement Project – Contract Change Order 10 (Water Service Extensions)

04/04/2024

Change Order No. 10

Contract No. 21/22-16

To: Anderson Pacific Engineering Construction, Inc.

This Change Order No. 10 for the San Lorenzo Valley Water District’s Alta Via Pipeline Replacement Project encompasses the following changes to Contract No. 21/22-16:

1. An Extra Cost adjustment encompassing additional work to connect relocated meters to customers’ homes, as well as additional erosion control, emergency paving along Monan Way, and additional work to tie into two existing water mains.
2. This \$117,253.32 includes expenses over 2 months (January 2024 and February 2024).

Payment Adjustment at Agreed Lump Sum of \$117,253.32; Adjusted Contract Price is \$2,687,231.03.

By signing this change order all parties agree to the preceding changes to the plans, specifications, and contract documents.

Brian Frus, Interim General Manager
San Lorenzo Valley Water District

Date: _____

Michael P. Gossett, Project Manager
Anderson Pacific Engineering Construction, Inc.

Date: _____



February 28, 2024

San Lorenzo Valley Water District
13060 CA-9
Boulder Creek, CA 95006

Attn: Steve Yazalina, Sandis

Reference: **Alta Via Pipeline Replacement Project, Potential Change Order No. 10- Water Service Extensions-Rev3.**

Mr. Yazalina:

APEC was directed to extend water services onto private property beyond the scope of contract work. This PCO includes Daily Extra Work Reports that covers additional labor, material and equipment to extend water services, as directed by the District.

Water Service Extension- January 2024:	\$60,931.39
Water Service Extension- February 2024:	\$58,194.73
Erosion Control Deduct:	(\$1,942.41)
TOTAL:	\$117,252.32

If you have any questions, please do not hesitate to contact me.

Regards,

Michael P. Gossett

Michael P. Gossett
Project Manager
Anderson Pacific Engineering Construction, Inc.

1370 Norman Avenue
Santa Clara, CA 95054
Lic. No. 245215

APEC Billing Summary Sheet

Bill To: SLVWD
Invoice #:
Billing Period: January, 2023

Job: 2202
Date:

Item#	Description	Date	Qty	Unit Price	% Billed	Price
1	PCO-10-01	1/15/2024	1	\$ 2,151.28	100%	\$ 2,151.28
2	PCO-10-02	1/16/2024	1	\$ 852.28	100%	\$ 852.28
3	PCO-10-03	1/15/2024	1	\$ 9,069.62	100%	\$ 9,069.62
4	PCO-10-04	1/16/2024	1	\$ 2,011.80	100%	\$ 2,011.80
5	PCO-10-05	1/17/2024	1	\$ 3,821.98	100%	\$ 3,821.98
6	PCO-10-06	1/17/2024	1	\$ 2,236.67	100%	\$ 2,236.67
7	PCO-10-07	1/18/2024	1	\$ 4,713.90	100%	\$ 4,713.90
8	PCO-10-08	1/18/2024	1	\$ 1,642.93	100%	\$ 1,642.93
9	PCO-10-08A	1/18/2024	1	\$ 2,138.49	100%	\$ 2,138.49
10	PCO-10-08B	1/19/2024	1	\$ 3,293.92	100%	\$ 3,293.92
11	PCO-10-09	1/23/2024	1	\$ 4,959.12	100%	\$ 4,959.12
12	PCO-10-10	1/25/2024	1	\$ 3,735.22	100%	\$ 3,735.22
13	PCO-10-11	1/26/2024	1	\$ 5,259.17	100%	\$ 5,259.17
14	PCO-10-12	1/29/2024	1	\$ 6,192.69	100%	\$ 6,192.69
15	PCO-10-13	1/30/2024	1	\$ 2,389.92	100%	\$ 2,389.92
16	PCO-10-14	1/30/2024	1	\$ 6,462.42	100%	\$ 6,462.42
17			1		100%	\$ -
18			1		100%	\$ -
19			1		100%	\$ -
20			1		100%	\$ -
21			1		100%	\$ -
22			1		100%	\$ -
23			1		100%	\$ -
24			1		100%	\$ -
25			1		100%	\$ -
26			1		100%	\$ -
27			1		100%	\$ -
28			1		100%	\$ -
29			1		100%	\$ -
30			1		100%	\$ -

Sub Total: \$ 60,931.39

Total \$ 60,931.39

Description of Work: Excavate and expose existing water meter, abandon and backfill; relocate water meter 33' to the East of current location @ 11654 Alta Via (Reference RFI No. 16)

EQUIP. NO.	EQUIPMENT	OT/Delay Factor	HOURS		HOURLY RATE	EXTENDED AMOUNTS	LABOR	HOURS		HOURLY RATE	EXTENDED AMOUNTS
			RT	OT				RT	OT		
1026	FORD F250 CREW TRUCK - UTILITY	1	5		\$ 42.39	\$ 211.95	13	5		\$ 99.79	\$ 498.95
7006	FORD F650 BOBTAIL DUMP TRUCK - 5 CY	1	5		\$ 73.34	\$ 366.70	41	5		\$ 76.50	\$ 382.50
3022	KOBELCO SK 45SRX-6E	1	5		\$ 48.03	\$ 240.15					
0		1								\$ 63.32	
0		1									
0		1									
0		1									
0		1									
0		1									
0		1									
0		1									
MATERIAL and/or TRUCKING											
Description		No. Units			Unit Cost	Amount					
Material	Ferguson- 63-0756460- fittings	1.00	LS		\$231.42	\$231.42			INCLUDED		\$ 881.45
		1.00	LS			\$0.00					
		1.00	LS			\$0.00			INCLUDED		
		1.00	LS			\$0.00					
		1.00	LS			\$0.00					
WORK DONE BY SUBCONTRACTOR and/or SPECIALISTS											
Description		No. Units			Unit Cost	Amount					
		1.00	LS			\$0.00					
		1.00	LS			\$0.00					
		1.00	LS			\$0.00					
TOTAL COST OF LABOR											
											\$ 881.45
											\$ 1,050.22
											\$ -
											\$ 114.59
											\$ 105.02
											\$ -
											\$ 2,151.28
TOTAL THIS REPORT											
13% MARK-UP ON LABOR COST											
10% MARK-UP ON EQUIPMENT, MATERIALS AND TRUCKING COST											
7% MARK-UP ON SUBCONTRACTOR AND SPECIALISTS COST											

RET DF1 16

ANDERSON PACIFIC

Engineering Construction, Inc.

BILLING INFORMATION:

NAME: Anderson Pacific
 ADDRESS: 1370 NORMAN AVE
 CITY/STATE/ZIP: SANTA CLARA, CA
 PHONE: 408-970-9900

108

DAILY EXTRA WORK REPORT

DATE PERFORMED 1/15/2024

WORK PERFORMED AT THE DIRECTION OF: SAN LORENZO WATER DISTRICT

CONTRACTOR JOB NO. 2202

CONTRACTOR REPORT NO.

DESCRIPTION OF WORK: DIG UP EXISTING WATER METER AND ABANDON AND BACKFILL

RELOCATE WATER METER 33' TO THE EAST OF EXISTING LOCATION 11654 BLDA VIA

EQUIP NO.	EQUIPMENT	HOURS	HOURLY/DAILY RATE	EXTENDED AMOUNTS	P.R. NO.	LABOR	HOURS	HOURLY RATE	EXTENDED AMOUNTS
1026	UTILITY TRUCK	5			03	TOMMY THORMAN			
7006	DUMP TRUCK	5				(DEVS)			
3022	ROLLER MINI	5			11	CHUY RAMOS			

DESCRIPTION	NO. UNIT	UNIT COST	EXTENDED	SUB-TOTAL	
				TOTAL COST OF LABOR	TOTAL A & B
MATERIAL AND/OR WORK DONE BY SPECIALISTS					
Focusus- 63-0751460 - fittings					
TOTAL COST OF EQUIPMENT, MATERIALS AND WORK					
					A
					B
ACCEPTED: <u>[Signature]</u> CONTRACTOR'S REPRESENTATIVE				TOTAL A & B MARKUP ON EQUIPMENT, MATERIAL AND WORK COST _____% TOTAL THIS REPORT	

OWNER/AGENT

INVOICE *1002*



235 River St
 Santa Cruz, CA 95060
 Credit Contact 831-420-2640
 Order Contact 831-426-1020

DELIVER	CUSTOMER NUMBER	JOB NUMBER	DOCUMENT NUMBER	DOCUMENT DATE
N	551913		63-0756460	01/15/24
DUE DATE	SALES CODE	SALES REP	DELIVERY DATE	REFERENCE NUMBER
02/10/24	25	40	01/15/24	2202
PLEASE REMIT TO:				
Builders FirstSource dba San Lorenzo Lumber PO Box 843909 Los Angeles CA 90084-3909				

RIVER STREET
 Sold To

Store 63

JOSE GOMEZ

Job:

ANDERSON PACIFIC ENG CONST INC
 1370 NORMAN AVE
 SANTA CLARA CA 95054-2056

General Account

PIECES	DESCRIPTION	SKU #	LINEAR FEET	BOARD SQ. FTG.	PRICE	U/M	EXTENDED AMOUNT
4	PVC PIPE SCH40 3/4" 9'11" LGTH	560449			11.49	EA	45.96
10	PVC BUSHING 1 X 3/4 ST	560124			2.29	EA	22.90
5	PVC BUSHING 1 X 3/4 SS	560107			2.29	EA	11.45
15	PVC 45 DEG. ELL 1" SS	560161			2.99	EA	44.85
6	PVC MALE ADAPTR 3/4X1" SXMIP	560502			3.99	EA	23.94
6	PVC FEMALE ADAPT 1" ST IMP	560096			1.29	EA	7.74
15	PVC 3/4" 45 ELL S X S	560090			1.79	EA	26.85
1	PVC 3/4" COUPLER SXS 10/BAG	561043			8.79	EA	8.79
1	PURPLE PVC PRIMER LO-VOC PINT	546339			14.79	EA	14.79
1	RED HOT PVC GLUE PINT A	543469			19.79	EA	19.79

RECEIVED
 FEB 05 2024
 APEC

Thank you for your business!
Payment must be received by the 10th.

TOTAL BOARD FT.	TOTAL SQUARE FT.	SUB-TOTAL	CARTAGE	TAX AMOUNT	INVOICE TOTAL
0	0	211.83	0.00	19.59	231.42

Customer Purchase Orders will be accepted for tracking purposes only, no additional obligation will be taken by San Lorenzo Lumber. San Lorenzo Lumber's credit terms and terms of sale prevail. ALL INVOICES FOR PURCHASE MADE ON OR BEFORE THE STATEMENT DATE ARE DUE AND PAYABLE ON THE 10TH DAY FOLLOWING THE STATEMENT DATE. A DELINQUENCY CHARGE OF 1.12% PER MONTH WILL BE IMPOSED ON BALANCE PAST DUE AS OF THE NEXT CLOSING DATE. CREDITS ALLOWED ON STOCK ITEMS RETURNED SUBJECT TO 15% HANDLING CHARGE. CARTAGE TO YARD AND CONDITION OF MATERIAL. SPECIAL ORDERS MAY NOT BE RETURNED.

Work Performed by:
Work Performed at the direction of:

ANDERSON PACIFIC ENGINEERING CONSTRUCTION, INC.
San Lorenzo Valley Water District

Description of Work:

Backfill trench with slurry @ 11654 Alta Via (Reference RFI 16)

APEC Job #: 2202
Date Performed: 1/16/2024
DEWR #: PCO-10-02

EQUIP. NO.	EQUIPMENT	OT/Delay Factor	HOURS		HOURLY RATE	EXTENDED AMOUNTS	LABOR	HOURS		HOURLY RATE	EXTENDED AMOUNTS
			RT	OT				RT	OT		
1018	FORD F150 PICKUP TRUCK	1	1		\$ 37.61	\$ 37.61	FOREMAN	1		\$ 105.82	\$ 105.82
94	FORD F150 PICKUP TRUCK	1			\$ 37.61		OPERATOR 3	1		\$ 99.79	\$ 99.79
7006	FORD F650 BOBTAIL DUMP TRUCK - 5 CY	1			\$ 73.34		LABORER 1	1		\$ 71.15	\$ 71.15
							J. Gomez				
3022	KOBELCO SK 45SRX-6E	1			\$ 48.03	\$ 48.03	LAB APP 3			\$ 63.32	
							D. Lizaola				
0		1			\$ -	\$ -	CONSTRUCTION SPECIALIST	1		\$ 71.93	\$ 71.93
							A. Flores				
0		1			\$ -	\$ -				\$ -	\$ -
										\$ -	\$ -
0		1			\$ -	\$ -				\$ -	\$ -
										\$ -	\$ -
0		1			\$ -	\$ -				\$ -	\$ -
										\$ -	\$ -
0		1			\$ -	\$ -				\$ -	\$ -
										\$ -	\$ -
0		1			\$ -	\$ -				\$ -	\$ -
										\$ -	\$ -
0		1			\$ -	\$ -				\$ -	\$ -
										\$ -	\$ -
MATERIAL and/or TRUCKING											
Description		No. Units			Unit Cost	Amount					
Material	Las Animas- 377799- 2 yds	1.00 LS			\$330.96	\$330.96	INCLUDED				\$
		1.00 LS			\$0.00	\$0.00	INCLUDED				\$
		1.00 LS			\$0.00	\$0.00					\$
		1.00 LS			\$0.00	\$0.00					\$
WORK DONE BY SUBCONTRACTOR and/or SPECIALISTS											
Description		No. Units			Unit Cost	Amount					
		1.00 LS			\$0.00	\$0.00					\$
		1.00 LS			\$0.00	\$0.00					\$
		1.00 LS			\$0.00	\$0.00					\$
TOTAL COST OF EQUIPMENT, MATERIALS AND TRUCKING											
TOTAL COST OF SUBCONTRACTOR AND SPECIALISTS											
											\$ 348.69
											\$ 416.60
											\$ -
											\$ 45.33
											\$ 41.66
											\$ -
TOTAL THIS REPORT											\$ 852.28

13% MARK-UP ON LABOR COST
10% MARK-UP ON EQUIPMENT, MATERIALS AND TRUCKING COST
7% MARK-UP ON SUBCONTRACTOR AND SPECIALISTS COST

DDL

LAS ANIMAS CONCRETE
P.O. BOX 507
Santa Cruz, CA 95061
831/426-7280

Sales Invoice 187554

Invoice Date: 01/18/2024

Due Date: 02/15/2024

Printed Date: 01/18/2024

Page: 1

Bill To:

Anderson Pacific
Attention: Accounts Payable
1370 Norman Avenue
Santa Clara, CA 95054

Ship To:

PROSPECT

RECEIVED
JAN 25 2024
APEC

Customer ID	Purchase Order	Terms	Ship Via	F.O.B.	Sales Person	Ship From	Source
AND2	PROSPECT	1% 15 Net 30			JF	WHSE	

Order Qty	U.O.M.	Description	Unit Price	Tax	Extended Price
8.00	YD	2.00 SK SAND SLURRY 377793	122.00000	Y	976.00
8.00	YD	Freight Chg - Bonny Doon, BC town 377793	20.00000	N	160.00
8.00	YD	2.00 SK SAND SLURRY 377799	122.00000	Y	976.00
8.00	YD	Freight Chg - Bonny Doon, BC town 377799	20.00000	N	160.00
90.00	EA	Standby Time	1.50000	N	135.00
2.00	YD	AB219	50.00000	N	100.00

2yd e 122⁰⁰
Tax 244⁰⁰
21.96

265.96
Freight 40⁰⁰
AB 219 25⁰⁰

\$330.96

Non Taxable Subtotal	555.00
Taxable Subtotal	1,952.00
Order Discount	0.00
Shipping/Handling	0.00
Tax	175.68
Order Total	2,682.68

IMPORTANT: SEE REVERSE FOR INFORMATION REGARDING MECHANICS LIEN LAWS, CREDIT SALE INFORMATION, & TERMS AND CONDITIONS OF SALE.

SOLD BY

Las Animas Concrete & Building Supply, Inc.

Agenda: 4.4.24
Item: 10c

Mailing Address: P.O. Box 507
Santa Cruz, CA 95061

Business Address:
146 ENCINAL STREET
SANTA CRUZ, CA 95060
831/426-7280

CAUTION: Freshly mixed concrete may cause skin irritation on prolonged exposure. Avoid direct contact where possible and wash exposed skin areas promptly with water. If any cementitious materials get into the eye, rinse immediately and repeatedly with water and get prompt medical attention. Keep out of reach of children.

SOLD TO:

SHIP TO:

ANDERSON PACIFIC

PROSPECT
SUNNY
BROOKDALE

*2 yds
POT-16*

TIME	MIX NO.	CU. YDS./METERS THIS LOAD	YDS./METERS ORD'D	USE	DRIVER/TRUCK	MAP COORDINATE	PLANT/TRANSACTION #
12:12 PM	003	1.00 yd	8.00 yd	PAVEMENT JOB			
DATE	NO. OF LOADS	ACCUM. YDS./METERS	BATCH #	WATER TRIM	SLUMP	TICKET NUMBER	
01/16/24	2	16.00 yd	2		3.00	1377	

NOTICE: MY SIGNATURE BELOW INDICATES THAT I HAVE READ THE HEALTH WARNING NOTICE AND SUPPLIER WILL NOT BE RESPONSIBLE FOR ANY DAMAGE CAUSED WHEN DELIVERING INSIDE CURB LINE.

WEIGHMASTER CERTIFICATE: THIS IS TO CERTIFY that the following described commodity was weighed, measured or counted by a weighmaster, whose signature is on this certificate, who is a recognized authority of accuracy, as prescribed by Chapter 7 (commencing with Section 12700) of Division 5 of the California Business and Professions Code, administered by the Division of Measurement Standards of the California Department of Food and Agriculture.

LAS ANIMAS CONCRETE & BUILDING SUPPLY, INC. AND DRIVER OF TRUCK are released from any responsibility of addition to colors due to variations in cement and aggregate materials or admixtures, and for damages which may be incurred in delivering materials across the curb or property line. Claims will not be allowed unless made at the time this material was delivered. **ADDITIONAL WATER ADDED TO THIS CONCRETE WILL REDUCE IT'S STRENGTH. ANY WATER ADDED IS AT CUSTOMER'S OWN RISK.**

JOB SITE CYLINDER TEST: YES NO
 Water Added _____ Gals. to full load YES
 On Job _____ Gals. to 2/3 load YES
 At Customer's Request _____ Gals. to 1/3 load YES

LAS ANIMAS CONCRETE & BUILDING SUPPLY, INC. WEIGHMASTER

WEIGHED AT: *

BY: _____ DEPU

CONCRETE IS A PERISHABLE COMMODITY AND BECOMES THE PROPERTY OF THE PURCHASER UPON LEAVING THE PLANT. ANY CHANGES OR CANCELLATION OF ORIGINAL INSTRUCTIONS MUST BE TELEPHONED TO OFFICE BEFORE LOADING STARTS

RECEIVED BY: **X**

AUTHORIZED BY:

X

QUANTITY	CODE	DESCRIPTION	PRICE CU. YD./METER	EXTENDED PRICE
1.00	ENV	ENVIRONMENTAL FEE		
1.00	FUEL	FUEL SURCHARGE		

LEAVE PLANT	ARRIVE JOB	START UNLOAD	FINISH UNLOAD	ARRIVE PLANT	TOTAL TIME
1235	1235	1220	320		

DELAY EXPLANATION/CYLINDER TEST TAKEN <input type="checkbox"/> JOB NOT READY <input type="checkbox"/> TRUCK BROKE DOWN <input type="checkbox"/> SLOW POUR OR PUMP <input type="checkbox"/> ACCIDENT <input type="checkbox"/> TRUCK AHEAD ON JOB <input type="checkbox"/> CITATION <input type="checkbox"/> CONTRACTOR BROKE DOWN <input type="checkbox"/> OTHER <input type="checkbox"/> ADDED WATER	Five (5) minutes per yd./meter free unloading time allowed. Additional unloading time charged at current hourly truck rate.	MINUTES STANDBY TIME:
		ADDITIONAL CHARGE 1. _____ ADDITIONAL CHARGE 2. _____ GRAND TOTAL ▶

CONTROL NO. 378799



DAILY EXTRA WORK REPORT

APEC Job #: 2202
Date Performed: 1/15/2024
DEWR #: PCO-10-03

ANDERSON PACIFIC ENGINEERING CONSTRUCTION, INC.
San Lorenzo Valley Water District

Work Performed by:
Work Performed at the direction of:

Description of Work: Trench for water meter connections- 12030 Alta Via, 11995 Alta Via, 11700 Alta Via, 11610 Alta Via

EQUIP. NO.	EQUIPMENT	OT/Delay Factor	HOURS		HOURLY RATE	EXTENDED AMOUNTS	LABOR	HOURS		HOURLY RATE	EXTENDED AMOUNTS
			RT	OT				RT	OT		
1018	FORD F150 PICKUP TRUCK	1	8		\$ 37.61	\$ 300.88	FOREMAN J. Swain	8		\$ 105.82	\$ 846.56
87	GMC SIERRA 1500 PICKUP TRUCK	1	8		\$ 37.61	\$ 300.88	CONSTRUCTION SPECIALIST A. Flores	8		\$ 71.93	\$ 575.44
7006	FORD F650 BOBTAIL DUMP TRUCK - 5 CY	1			\$ 73.34	-	LABORER 1 F. Flores	8		\$ 71.15	\$ 569.20
3022	KOBELCO SK 45SRX-6E	1			\$ 48.03	-	LAB APP 3 D. Lizaola Ramos	8		\$ 63.32	\$ 508.56
0		1			\$ -	-	LABORER 1 T. Etchison	8		\$ 71.15	\$ 569.20
0		1			\$ -	-	LABORER 1 G. Zavala	8		\$ 71.15	\$ 569.20
0		1			\$ -	-				\$ -	\$ -
0		1			\$ -	-				\$ -	\$ -
0		1			\$ -	-				\$ -	\$ -
0		1			\$ -	-				\$ -	\$ -
0		1			\$ -	-				\$ -	\$ -
0		1			\$ -	-				\$ -	\$ -
0		1			\$ -	-				\$ -	\$ -
0		1			\$ -	-				\$ -	\$ -
MATERIAL and/or TRUCKING											
Description		No. Units			Unit Cost	Amount					
Rental	Cresco- Pneumatic Piercing Tool- 6073406	1.00	LS		\$3,579.67	\$3,579.67		INCLUDED			\$ 3,636.16
Material	San Lorenzo Lumber- 63-0756460- fittings	1.00	LS		\$231.42	\$231.42					\$ -
Material	Scarborough Lumber- 628319/5	1.00	LS		\$14.66	\$14.66		INCLUDED			\$ -
Material	Ferguson- 1837293	1.00	LS		\$82.27	\$82.27					\$ -
		1.00	LS		\$0.00	\$0.00					\$ -
WORK DONE BY SUBCONTRACTOR and/or SPECIALISTS											
Description		No. Units			Unit Cost	Amount					
		1.00	LS			\$0.00					\$ -
		1.00	LS			\$0.00					\$ -
		1.00	LS			\$0.00					\$ -
TOTAL COST OF EQUIPMENT, MATERIALS AND TRUCKING											
TOTAL COST OF SUBCONTRACTOR AND SPECIALISTS											
											\$ 3,636.16
											\$ 4,509.78
											\$ -
											\$ 472.70
											\$ 450.98
											\$ -
											\$ 9,069.62

13% MARK-UP ON LABOR COST
 10% MARK-UP ON EQUIPMENT, MATERIALS AND TRUCKING COST
 7% MARK-UP ON SUBCONTRACTOR AND SPECIALISTS COST

TOTAL THIS REPORT

ANDERSON PACIFIC

Engineering Construction, Inc.

BILLING INFORMATION:

NAME: ANDERSON PACIFIC
 ADDRESS: 1370 NORMAN AVE
 CITY/STATE/ZIP: SANTA CLARA CA
 PHONE: 408-970-9900

115

DAILY EXTRA WORK REPORT

DATE PERFORMED 1/15/2024

WORK PERFORMED AT THE DIRECTION OF: SAN LUCAS WATER DISTRICT

CONTRACTOR JOB NO. 2202
 CONTRACTOR REPORT NO.

DESCRIPTION OF WORK: TRENCH FOR WATER METER CONNECTIONS

12030 ALTA VIA - 11995 ALTA VIA - 11700 ALTA VIA - 11610 ALTA VIA

EQUIP NO.	EQUIPMENT	HOURS	HOURLY/DAILY RATE	EXTENDED AMOUNTS	P.R. NO.	LABOR	HOURS	HOURLY RATE	EXTENDED AMOUNTS
1014	FORD F-150	8			F	JOE SWAIN	REG. 8		
87	GENC SIERRA	8			CS	ANA FLORES	REG. 8		
	HONDA GENERATOR	8			LA3	DANIEL RAMOS	REG. 8		
	ROTO HAMMER	8			L1	FRANCISCO AVILA-FLORES	REG. 8		
					L1	TIM ETELISSA	REG. 8		
					L1	GUILLERMO ZAVALA	REG. 8		
							O.T.		
							REG.		
							O.T.		
							REG.		
							O.T.		

MATERIAL AND/OR WORK DONE BY SPECIALISTS		NO. UNIT	UNIT COST	EXTENDED	SUB-TOTAL	
DESCRPTION						
Cresco - Mole 6073405					PAYROLL BURDEN AND/OR MARKUPS	
San Lorenzo Lumpur - 63-0756060 - PVC pipe pushings						
Scarborough Building Supply - 628 3/19/5 - three seal tape						
Ferguson - 1837553 - 1" poly line						
TOTAL COST OF EQUIPMENT, MATERIALS AND WORK					TOTAL COST OF LABOR	
					A	
					B	

ACCEPTED: _____

CONTRACTOR'S REPRESENTATIVE

OWNER/AGENT

TOTAL A & B

MARKUP ON EQUIPMENT, MATERIAL AND WORK COST _____%

TOTAL THIS REPORT



**RENTAL RETURN
SCL**

**PAGE: 1
OUT: GIL**

Remit to: PO Box 2359 Livermore, CA 94551
Billing inquiries: (925)-961-0130 FAX (925) 456-9827
Customer service: 1 (800) 649-6629

**CUSTOMER: ANDERSON-PACIFIC ENGINEERING C
1370 NORMAN AVE
SANTA CLARA, CA 95054**

P.O. #: 2202
ORDERED BY: ANDON
JOB LOCATION: WILL CALL ALTA VIA DR & PROSPECT
JOB #: 2202

Invoice#	Date
6073406-0002	2/06/24
Date and Time Out	By
1/15/24 12:30 PM	GILBERTT
Date and Time In	By
1/30/24 4:00 PM	SALVADORT
Phone#	Alt Phone/Cell
408-970-9900	
Account #	Fax#
2000	408-970-9975
Drivers Lic	Payment Method

QTY	RENTAL ITEMS	DESCRIPTION	MINIMUM	RENTAL RATES			AMOUNT CHARGED
				DAY	WEEK	4 WEEKS	
1	30544003	2*PNEUMATIC PIERCING TOOL (MOLE) Make: DITCHWITCH Model: 21722 Serial #: 146917		300.00	885.00	2495.00	2370.00

SALES ITEMS		DESCRIPTION	UNIT	PRICE	DISC. %	DISC. \$	AMOUNT CHARGED
QTY	ITEM NUMBER						
1	BH82000	COMBO PINTLE/BALL HITCH 2" 16K#	EA	164.280			164.28
1	PM87	PINTLE MOUNT, COMBO HITCH/10K# (BH82000)	EA	77.175			77.18
3	ET20210	STRIKER RING	EA	26.300			78.90
1	ET20717	CONTROL SLEEVE	EA	99.200			99.20
1	ET20727	EXTERNAL WHIP	EA	89.300			89.30

**RECEIVED
FEB 06 2024
APEC**

CONTINUED...

TOTAL RENTAL AMOUNT	DELIVERY	PICK-UP	FUEL	TOTAL SALES ITEMS	SUB TOTAL	TAX	EQUIPMENT PROTECT PLAN	MISC	LABOR WEAR
									TOTAL CHARGES
									DEPOSIT RECEIVED
									AMOUNT DUE OR < REFUND >

CREDIT/DEBIT CARDS
I agree to pay the amount shown according to the card issuer agreement.

SIGNING PERSONALLY AND FOR THE CUSTOMER

X _____



**RENTAL RETURN
SCL**

Remit to: PO Box 2359 Livermore, CA 94551
Billing inquiries: (925)-961-0130 FAX (925) 456-9827
Customer service: 1 (800) 649-8629

**CUSTOMER: ANDERSON-PACIFIC ENGINEERING C
1370 NORMAN AVE
SANTA CLARA, CA 95054**

P.O. #: 2202
ORDERED BY: ANDON
JOB LOCATION: WILL CALL ALTA VIA DR & PROSPECT
JOB #: 2202

Invoice#	Date
6073406-0002	2/06/24
Date and Time Out	By
1/15/24 12:30 PM	GILBERTT
Date and Time In	By
1/30/24 4:00 PM	SALVADORT
Phone#	Alt Phone/Cell
408-970-9900	
Account #	Fax#
2000	408-970-9975
Drivers Lic	Payment Method

SALES ITEMS		DESCRIPTION	UNIT	PRICE	DISC. %	DISC. \$	AMOUNT CHARGED
QTY	ITEM NUMBER						
2	ET21717	VALVE RING	EA	71.200			142.40
1	LABOR-OUTSIDE	VENDOR LABOR DONE BY OUTSIDE VENDOR-BTC REQUEST FOR INSPECTON AND REPAIR OF THIR R OWN 2" PIERCING TOOL. DISASSEMBLED AND REPLACED WEAR RINGS AND SEALS. ALOS REP LACE SHORT HOSE WHIP ON THE END OF THE T OOL. TESTED ALL OKAY AT THIS TIME.	EA	217.500			217.50
1	DELIVERY/FRT B	DEL/FRT TO CUSTOMER OUTSIDE CARRIER (B)	EA	43.470			43.47
1	PROPTAX	CACC 1656.5 PROP TAX RECOVERY FEE(.75%)	EA	17.775			17.78

TOTAL RENTAL AMOUNT	DELIVERY	PICK-UP	FUEL	TOTAL SALES ITEMS	SUB TOTAL	TAX	EQUIPMENT PROTECT/PLAN	MISC	LABOR WEAR	
2370.00				651.26	3238.76	9.125 279.66		61.25	217.50	
									TOTAL CHARGES	3579.67
									DEPOSIT RECEIVED	
									AMOUNT DUE OR < REFUND >	

CREDIT/DEBIT CARDS
I agree to pay the amount shown according to the card issuer agreement.

SIGNING PERSONALLY AND FOR THE CUSTOMER:

X _____



**Equipment Rentals
& Affiliates**

RENTAL OUT

GILROY STORE
6390 Automall Parkway
Gilroy, CA 95020
(408) 846-1830
Mon-Fri 7-5

Agenda: 4.4.24
Item: 10c
PAGE: 1
OUT: GIL
REP: 15

Billing inquiries: (925)-961-0130 FAX (925) 456-9827
Customer service: 1 (800) 649-6629

CUSTOMER: **ANDERSON-PACIFIC ENGINEERING C**
1370 NORMAN AVE
SANTA CLARA, CA 95054

P.O. #: 2202
ORDERED BY: ANDON
JOB LOCATION: WILL CALL ALTA VIA DR & PROSPECT
JOB #: 2202

Contract#	Date
6073406	1/15/24
Date and Time Out	By
1/15/24 12:30 PM	GILBERTT
Date and Time In	By
Phone#	Alt Phone/Cell
408-970-9900	
Account #	Fax#
2000	408-970-9975
Drivers Lic	Payment Method



QTY	RENTAL ITEMS	DESCRIPTION	MINIMUM	RENTAL RATES			ESTIMATED AMOUNT
				DAY	WEEK	4 WEEKS	
1	12999006	3"PNEUMATIC PIERCING TOOL (MOLE) Make: DITCHWITCH Model: 30822 Serial #: 145483		375.00	1185.00	3120.00	

SALES ITEMS		DESCRIPTION	UNIT	PRICE	DISC. %	DISC. \$	ESTIMATED AMOUNT
QTY	ITEM NUMBER						
1	PROPTAX	CACC 1656.5 PROP TAX RECOVERY FEE (.75%)	EA	8.888			
1	ENVIRONMENTAL	CHARGE EPA CHARGE/WASTE FEES	EA				
		DELIVERY INSTRUCTIONS: POC is Andon 408 316 4835					

9909

WHEN OPERATED IN CALIFORNIA, ANY OFF-ROAD DIESEL VEHICLE MAY BE SUBJECT TO THE CALIFORNIA AIR RESOURCES BOARD (CARB) OFF-ROAD 5 MINUTE IDLING PROVISION. PLEASE VISIT THE CALIFORNIA AIR RESOURCES BOARD WEBSITE AT WWW.ARB.CA.GOV/MSPROG/ORDIESEL/ORDIESEL.HTM.

TOTAL RENTAL AMOUNT	DELIVERY	PICK-UP	FUEL	TOTAL SALES ITEMS	SUB TOTAL	TAX	EQUIPMENT PROTECTION PLAN	MISC	LABOR/WEAR
						9.125			
ACCEPTS	DECLINES	EQUIPMENT PROTECTION PLAN: For an additional fee of 14 % of the total rental on equipment (including vehicles), Cresco Equipment Rentals agrees to waive claims for damages to equipment as specified on the back of the rental agreement. EQUIPMENT PROTECTION PLAN IS NOT INSURANCE.				INITIALS	INSTRUCTIONS: I have received adequate instructions to operate or allow rented equipment to be operated or used.		ESTIMATED CHARGES
									DEPOSIT RECEIVED
									EST. DUE OR <REFUND>

I have read, discussed and understand the terms and conditions of the Agreement and agree to be bound thereto. Credit/Debit Cards - Pursuant to the terms of this Cresco Rental Agreement, I promise to pay all credit/debit card charges to my account without the necessity of my signing or receiving a transaction statement.

SIGNING PERSONALLY AND FOR THE CUSTOMER:

X _____

Cresco Equipment Rentals agrees to be bound by the terms and conditions of the Agreement.
CRESCO EQUIPMENT RENTALS:

BY:

RENTAL AGREEMENT

CUSTOMER COPY

235 RIVER ST
SANTA CRUZ CA 95060-2720 (831) 426-1020

ANDERSON PACIFIC ENG CONST INC
1370 MORGAN AVE
SANTA CLARA CA 95054-0000

PHONE #: 408-970-9900

119

S O L D T O

DOCUMENT TYPE
CHARGE SALE

General Account

J
O
B



PC	CUSTOMER NUMBER	JOB NUMBER	DOCUMENT NUMBER	DOCUMENT DATE
02	551913		63-0756660	1/15/24

ORDERED BY		CUSTOMER REFERENCE/PO NUMBER	
JOSE GOMEZ		2202	

DL NUMBER	CC NUMBER	DELIVER	DELIVERY DATE	SALES CODE	SALES REP
	0000000	N	1/15/24	25	40

QTY	DESCRIPTION	MFG. #	SKU	UPC	LINEAL FEET	BOARD/SQUARE	PRICE	U/M	EXTENDED AMOUNT
4	PVC PIPE SCH40 3/4" 9'11" LGTH	070435	560449	752606-200499			11.49	EA	45.96
10	PVC BUSHING 1 X 3/4 ST	365131	560124	049081-134464			2.29	EA	20.61
5	PVC BUSHING 1 X 3/4 SS	368131	560107	049081-133108			2.29	EA	10.31
15	PVC 45 DEG. ELL 1" SS	365010	560161	049081-140267			2.99	EA	40.37
6	PVC MALE ADAPTR 3/4X1" SMP	367131	560096	049081-130527			3.99	EA	21.55
6	PVC FEMALE ADAPT 1" ST IMP	368010	560090	049081-140243			1.29	EA	6.97
15	PVC 3/4" 45 ELL S X S	365007	561043	012871-636172			1.79	EA	24.17
1	PVC 3/4" COUPLER SXS 10/BAG	119526	561043	012871-636172			8.79	EA	8.79
1	PURPLE PVC PRIMER LO-VOC PINT	360059	546339	054647-080105			14.79	EA	13.31
1	RED HOT PVC BLUE PINT	360402	543469	044752-110167			19.79	EA	19.79

990A

Customer Purchase Orders will be accepted for tracking purposes only, no additional obligation will be taken by Builders FirstSource. BFS's credit terms and terms of sale prevail.

CHECKED BY	DELIVERED BY	TOTAL BOARD FEET	TOTAL SQ. FEET	SUB-TOTAL	CARTAGE	TAX AMOUNT	DOCUMENT TOTAL
				211.83	.00	19.59	231

THE UNDERSIGNED AGREES TO THE ADDITIONAL TERMS AND CONDITIONS ON THE REVERSE SIDE. FOR MORE INFORMATION REGARDING HAZARDOUS MATERIAL, PLEASE REFER TO THE REVERSE SIDE. THE ABOVE DESCRIBED MATERIAL CHECKED & RECEIVED IN GOOD CONDITION.

BY **X Jose Gomez**

MILLING/SPECIAL ORDERED - PLEASE READ

CUSTOMER AGREES THAT THIS ORDER LISTED ABOVE IS CORRECT IN EVERY DETAIL IF THIS ORDER IS CANCELLED OR IF CUSTOMER FAILS TO PICK UP MATERIAL WITHIN 14 DAYS AFTER NOTIFICATION. CUSTOMER AGREES TO PAY ALL HANDLING CHARGES FOR MATERIALS RETURNED TO SUPPLIER AND FURTHER AGREES TO PAY ENTIRE PURCHASE PRICE IF MATERIAL CANNOT BE RETURNED.

CUSTOMER SIGNATURE _____

APPROX DATE REC _____ DATE NOTIFIED _____

P.O. _____

NON REFUNDABLE RETURN CHARGE _____

CUSTOMER COPY

SCARBOROUGH BUILDING SUPPLY
12990 HWY 9, BOULDER CREEK
MAIL: P.O. BOX 66599
SCOTT'S VALLEY, CA 95067
PHONE: (831) 338-6467

30 DAYS** + RECEIPT REQUIRED ON
 ALL RETURNS / EXCHANGES

120

Customer No. 12617	Job No.	Purchase Order No. 2202	Reference BROOKDALE	Terms 1% 10TH, NET 11TH,	Clerk SMC	Date 1/15/24	Time 10:17
-----------------------	---------	----------------------------	------------------------	-----------------------------	--------------	-----------------	---------------

Sold To
 * ANDERSON PACIFIC ENGINEERING
 1370 NORMAN AVE.
 SANTA CLARA, CA 95054
 (408) 970-9900

Ship To

DOC# 628319/5

 * INVOICE *

 SLSPR: 00 DEFAULT
 TAX : 500 SALES TAX: S CRUZ COU

SHIPPED	ORDERED	UM	SKU	DESCRIPTION	UNITS	PRICE/PER	EXTENSION	
2		EA	4237624	THREAD SEAL TAPE1/2X260	2	1.49 /EA	2.98	
4		EA	4312641	THREAD SEAL TAPE3/4X520	4	2.99 /EA	11.96	
							14.66	
** AMOUNT CHARGED TO STORE ACCOUNT **								
(GOMEZ, JOSE)								
							14.94	
							0.00	
							14.94	
							-1.49	
							1.21	
							14.66	

X *José Gomez*
 Received By

FERGUSON
WATERWORKS
 66 TARP CIRCLE
 SALINAS, CA 93901-3717

INVOICE NUMBER	TOTAL DUE	CUSTOMER	PAGE
1837293	\$82.27	450404	1 of 1

**PLEASE REFER TO INVOICE NUMBER WHEN
 MAKING PAYMENT AND REMIT TO:**

FERGUSON WATERWORKS #1423
 PO BOX 740827
 LOS ANGELES, CA 90074-0827

Please contact with Questions: 916-381-6100

MASTER ACCOUNT NUMBER: 165276

SHIP TO:

COUNTER PICK UP
 66 TARP CIRCLE
 SALINAS, CA 93901-3717

ANDERSON PACIFIC ENG CONST INC
 1390 NORMAN AVENUE
 BOULDER CREEK WWTP JON NO
 SANTA CLARA, CA 95054

SHIP WHSE.	SELL WHSE.	TAX CODE	CUSTOMER ORDER NUMBER	SALESMAN	JOB NAME	INVOICE DATE	BATCH
3306	3306	CA27SL	2202	SCC	BOULDER CREEK WWTP JON NO	01/17/24	IO 91801

ORDERED	SHIPPED	ITEM NUMBER	DESCRIPTION	UNIT PRICE	UM	AMOUNT
100	100	AX41250100B	1X100 CTS 250 PSI NSF BLK	0.753	FT	75.30
			INVOICE SUB-TOTAL			75.30
			TAX	Monterey/Salinas		6.97

LEAD LAW WARNING: IT IS ILLEGAL TO INSTALL PRODUCTS THAT ARE NOT "LEAD FREE" IN ACCORDANCE WITH US FEDERAL OR OTHER APPLICABLE LAW IN POTABLE WATER SYSTEMS ANTICIPATED FOR HUMAN CONSUMPTION PRODUCTS WITH *NP IN THE DESCRIPTION ARE NOT LEAD FREE AND CAN ONLY BE INSTALLED IN NON-POTABLE APPLICATIONS. BUYER IS SOLELY RESPONSIBLE FOR PRODUCT SELECTION.

WATER FLOW RATE NOTICE: LAVATORY FAUCETS WITH FLOW RATES OVER 0.5 GPM ARE NOT ALLOWED FOR 'PUBLIC USE' IN CALIFORNIA.

RECEIVED
 JAN 18 2024
 APEC

Looking for a more convenient way to pay your bill?
 Log in to [Ferguson.com](https://www.ferguson.com) and request access to Online Bill Pay.



TERMS: NET 10TH PROX	ORIGINAL INVOICE	TOTAL DUE	\$82.27
----------------------	------------------	-----------	---------

All past due amounts are subject to a service charge of 1.5% per month, or the maximum allowed by law, if lower. If Buyer fails to pay within terms, then in addition to other remedies, Buyer agrees to pay Seller all costs of collection, including reasonable attorney fees. Complete terms and conditions are available upon request or at <https://www.ferguson.com/content/website-info/terms-of-sale>, incorporated by reference. Seller may convert checks to ACH.



FERGUSON WATERWORKS #3306
66 TARP CIRCLE
SALINAS, CA 93901-3717

122

ORDER NO. 1937293
REQUIRED DATE 01/15/24
SHIP WHS. 3306
SELL WHS. 3306

STOCK SALES ORDER

ACCEPT B/O = N
SHOWROOM = N
SOURCE = SOE
IB RT = N 0.00
OP SHP = N 0.00
16 JAN 2024 18:50:28

WRITER SALESMAN
SD SCC/JPL
TAG PO. NO.

CUSTOMER NO. 450604
CUSTOMER ALPHA ANDERSONP
CONTRACT NO.
ANDERSON PACIFIC ENG CONST INC
1290 NORMAN AVENUE
BOULDER CREEK WATP JON NO
SANTA CLARA, CA 95054

ORDER DATE 01/15/24
ORDERED BY DANIEL
SHIP TO
COUNTER PICK UP
66 TARP CIRCLE
SALINAS, CA 93901-3717

INSTRUCTIONS
CPU COUNTER PICK-UP

CUSTOMER PO. NO. 2202
JOB NAME BOULDER CREEK WATP JON NO

ATTN:

SHIP VIA
CPU COUNTER PICK-UP

LINE	ORDER QTY	SHIP QTY	ITEM CODE	DESCRIPTION	UNIT PRICE	U/M	TOTAL	DELIVERED BY	PACKED BY	PO. NO.	PO. NO.	AISE LOC
1	100	100	U AX4125U100Y	EX100 C15 25U P51 NSF BK				CPU	[Signature]	0-2 1D		015-02
<p>***** END LAW WARNING: IT IS ILLEGAL TO INSTALL PRODUCTS THAT ARE NOT "LEAD FREE" IN ACCORDANCE WITH US FEDERAL OR OTHER APPLICABLE LAW IN POTABLE WATER SYSTEMS ANTICIPATED FOR HUMAN CONSUMPTION. PRODUCTS WITH SNF IN THE DESCRIPTION ARE NOT LEAD FREE AND CAN ONLY BE INSTALLED IN NON-POTABLE APPLICATIONS. BUYER IS SOLELY RESPONSIBLE FOR PRODUCT SELECTION. ***** WATER FLOW RATE NOTICE: Lavatory faucets with flow rates over 0.5 GPM are not allowed for public use in California. *****</p>												
					SUBTOTAL							
					TAX							
					OUTBOUND SHIPPING							
					INBOUND FREIGHT							
					LESS DEPOSIT							
					TOTAL DUE							

CUSTOMER'S SIGNATURE: *Daniel Lizaola* DATE: 1/16/24

TERMS: CUSTOMER COPY

Agenda: 4.4.24
Item: 10c

Description of Work: Trench, install and backfill water meter connections

EQUIP. NO.	EQUIPMENT	OT/Delay Factor	HOURS		HOURLY RATE	EXTENDED AMOUNTS	LABOR		HOURLY RATE	EXTENDED AMOUNTS
			RT	OT			RT	OT		
1018	FORD F150 PICKUP TRUCK	1	4		\$ 37.61	\$ 150.44	49	FOREMAN	\$ 105.82	\$ 423.28
					\$ -	\$ -		J. Swain	\$ -	\$ -
87	GMC SIERRA 1500 PICKUP TRUCK	1			\$ 37.61	\$ -		0	\$ -	\$ -
					\$ -	\$ -		A. Flores	\$ -	\$ -
7006	FORD F650 BOBTAIL DUMP TRUCK - 5 CY	1			\$ 73.34	\$ -	1	LABORER 1	\$ 71.15	\$ 284.60
					\$ -	\$ -		F. Flores	\$ -	\$ -
3022	KOBELCO SK 45SRX-6E	1			\$ 48.03	\$ -	LA3	LAB APP 3	\$ 63.32	\$ 253.28
					\$ -	\$ -		D. Lizaola Ramos	\$ -	\$ -
0		1			\$ -	\$ -	1	LABORER 1	\$ 71.15	\$ -
					\$ -	\$ -		T. Etchison	\$ -	\$ -
0		1			\$ -	\$ -	1	LABORER 1	\$ 71.15	\$ 284.60
					\$ -	\$ -		G. Zavala	\$ -	\$ -
0		1			\$ -	\$ -		0	\$ -	\$ -
					\$ -	\$ -		0	\$ -	\$ -
0		1			\$ -	\$ -		0	\$ -	\$ -
					\$ -	\$ -		0	\$ -	\$ -
0		1			\$ -	\$ -		0	\$ -	\$ -
					\$ -	\$ -		0	\$ -	\$ -
0		1			\$ -	\$ -		0	\$ -	\$ -
					\$ -	\$ -		0	\$ -	\$ -
0		1			\$ -	\$ -		0	\$ -	\$ -
					\$ -	\$ -		0	\$ -	\$ -
MATERIAL and/or TRUCKING										
Description		No. Units			Unit Cost	Amount				
Material	Core & Main- U237874	1.00 LS			\$339.42	\$0.00			INCLUDED	\$
Material	San Lorenzo Lumber- 63-075684	1.00 LS			\$59.31	\$59.31			INCLUDED	\$
		1.00 LS			\$0.00	\$0.00				
		1.00 LS			\$0.00	\$0.00				
WORK DONE BY SUBCONTRACTOR and/or SPECIALISTS										
Description		No. Units			Unit Cost	Amount				
		1.00 LS			\$0.00	\$0.00				
		1.00 LS			\$0.00	\$0.00				
		1.00 LS			\$0.00	\$0.00				
TOTAL COST OF LABOR										
										\$ 1,245.76
TOTAL COST OF EQUIPMENT, MATERIALS AND TRUCKING										\$ 549.17
TOTAL COST OF SUBCONTRACTOR AND SPECIALISTS										\$ -
13% MARK-UP ON LABOR COST										\$ 161.95
10% MARK-UP ON EQUIPMENT, MATERIALS AND TRUCKING COST										\$ 54.92
7% MARK-UP ON SUBCONTRACTOR AND SPECIALISTS COST										\$ -
TOTAL THIS REPORT										\$ 2,011.80

ANDERSON PACIFIC

Engineering Construction, Inc.

BILLING INFORMATION:
 NAME: ANDERSON PACIFIC
 ADDRESS: 370 NORMAN AVE
 CITY/STATE/ZIP: SANTA CLARA, CA
 PHONE: 408.970.9900

DAILY EXTRA WORK REPORT

DATE PERFORMED 1/16/2024

WORK PERFORMED AT THE DIRECTION OF: SAN LORENZO WATER DISTRICT

CONTRACTOR JOB NO. 2202

DESCRIPTION OF WORK: TRENCH, INSTALL & BACKFILL WATER METER CONNECTION

CONTRACTOR REPORT NO.

EQUIP NO.	EQUIPMENT	HOURS	HOURLY/DAILY RATE	EXTENDED AMOUNTS	P.R. NO.	LABOR	HOURS	HOURLY RATE	EXTENDED AMOUNTS	SUB-TOTAL	
										TOTAL COST OF LABOR	MARKUP ON EQUIPMENT, MATERIAL AND WORK COST %
1018	Ford F-150	4			F	JOE SWANW	REG. 4				
					LAP	DANIEL RAMOS	REG. 4				
					LI	FRANCISCO AVILA FLORES	REG. 4				
					LI	GUILLERMO ZAVALEA	REG. 4				
							O.T.				
							REG.				
							O.T.				
							REG.				
							O.T.				
							REG.				
							O.T.				
MATERIAL AND/OR WORK DONE BY SPECIALISTS											
	Core & Man - 4237874 - 1" poly line										
	San Lorenzo Lumber - 63-075684 - reducer, pipe gas										
TOTAL COST OF EQUIPMENT, MATERIALS AND WORK											A
TOTAL A & B											B
MARKUP ON EQUIPMENT, MATERIAL AND WORK COST %											
TOTAL THIS REPORT											

ACCEPTED: [Signature]

CONTRACTOR'S REPRESENTATIVE

OWNER/AGENT



INVOICE

1830 Craig Park Court
St. Louis, MO 63146

Invoice # U237874
Invoice Date 1/18/24
Account # 209395
Sales Rep ROBERT BARTHOLOMEW
Phone # 831-663-3741
Branch #285 Salinas, CA
Total Amount Due \$339.42

Remit To:
CORE & MAIN LP
PO BOX 46911
ST. LOUIS, MO 63146

ANDERSON PACIFIC ENGINEERING 000/0000
1370 NORMAN AVE 00000
SANTA CLARA CA 95054-2056

Shipped To:
CUSTOMER PICK-UP

CUSTOMER JOB- SCOTTSV SCOTTS VALLEY O BOULDER CREEK

Thank you for the opportunity to serve you! We appreciate your prompt payment.

Date Ordered	Date Shipped	Customer PO #	Job Name	Job #	Bill of Lading	Shipped Via	Invoice#
1/16/24	1/17/24	2202	SCOTTS VALLEY O	SCOTTSV		WILL CALL	U237874

Product Code	Description	Quantity		B/O	Price	UM	Extended Price
		Ordered	Shipped				

0910E250C1	1X100 CTS PE TUBING 250PSI PE 4710 NSF SDR-9 D2737 BLACK	500	500		.63000 FT		315.00
------------	---	-----	-----	--	-----------	--	--------

RECEIVED
JAN 19 2024
APEC

2202

Freight Delivery Handling Restock Misc

Subtotal: 315.00
Other: .00
Tax: 24.42

Terms: 2% 30 DAYS If paid by 2/17, deduct \$6.30
Ordered By: DANNY

Invoice Total: \$339.42

This transaction is governed by and subject to Core & Main's standard terms and conditions, which are incorporated by reference and accepted.
To review these terms and conditions, please visit: <http://tandc.coreandmain.com/>

125

PROMISED: 1/16/24
 FILLED BY: *TC*
 CHECKED BY:
 REVIEWED BY:
 ENTERED BY: TYCHE CARVEIRO - 285



PICK TICKET U237874

SALINAS CA Branch - 285 831 El Camino Real North CA 93907 PHONE # 831 663 3741		01/16/2024 03:29 PM PAGE 1	
ANDERSON PACIFIC ENGINEERING STOCK - UNION CITY 1370 NORMAN AVE SANTA CLARA CA 95054-2056 CUS PH# 408 970 9900		CUSTOMER PICKUP ANDERSON PACIFIC ENGINEERING Branch - 285 831 El Camino Real North Salinas CA 93907	
BRANCH NO. 285	DATE ORDERED 1/16/24	DATE SHIPPED 1/16	PURCHASE ORDER NO. 2202
BIN LOCATION Y09 1 A		PRODUCT CODE 0910E250C1	

BIN LOCATION	DATE ORDERED	DATE SHIPPED	PURCHASE ORDER NO.	JOB NUMBER	DELIVERY METHOD			QTY ORDERED	QTY SHIPPED	BACK ORDERED	UNIT PRICE	PER	AMOUNT
					OUR TRUCK	CUSTOMER PICKUP	DIRECT						
Y09 1 A	1/16/24	1/16	2202				X	500	500		FT		
DANNY 1X100 CTS PE TUBING 250PSI PE 4710 NSF SDR-9 D2737 BLACK *REF 5.00 LB RL * WEIGHT: .2410 LB TOTAL WEIGHT: 120.50													
ORDERED BY: 0910E250C1													
BOULDER CREEK DESCRIPTION													
RESTOCKING HANDLING DELIVERY FREIGHT TAX AMOUNT TAX													
MERCHANDISE SUBTOTAL END OF ORDER													

Agenda: 4.4.24
 Item: 10c

RECEIVED BY SIGNATURE: _____
 PRINT NAME HERE: _____

U237874209395

This transaction is governed by and subject to Core & Main's standard terms and conditions, which are incorporated by reference and accepted. To review these terms and conditions, please visit <http://tandc.coreandmain.com/>.



235 RIVER ST
SANTA CRUZ CA 95060-2720 (831) 426-1020

ANDERSON PACIFIC ENG CONST INC
1370 NORMAN AVE
SANTA CLARA CA 95054-0000

PHONE #: 408-970-9900

DOCUMENT TYPE
CHARGE SALE

RAIL TRAIL SEG7-PH2 #2208
110 CALIFORNIA ST S.C.

J
O
B



FC	CUSTOMER NUMBER	JOB NUMBER	DOCUMENT NUMBER	DOCUMENT DATE	
02	551913	11	63-0756684	1/16/24	
ORDERED BY: JOSE					
CUSTOMER REFERENCE NO. NUMBER: 228					
DL NUMBER	CC NUMBER	DELIVERED	DELIVERY DATE	SALES CODE	SALES REF
	0000000	N	1/16/24	25	40

QTY	DESCRIPTION	MFG. #	SKU	UPC	LINEAL FEET	BOARD SQUARE	PRICE	U/M	EXTENDED AMOUNT
9	GALV BELL RED 1 X 3/4	440121	551056	054374-023994			4.79	EA	38.80
1	BERNZONATIC HAPP PRO 14 OZ	332477	572377	014045-324779			15.49	EA	15.49
<i>2026</i>									
Customer Purchase Orders will be accepted for tracking purposes only, no additional obligation will be taken by Builders FirstSource. BFS's credit terms and terms of sale prevail.									
CHECKED BY		DELIVERED BY		TOTAL BOARD FEET	TOTAL SQ. FEET	SUB-TOTAL	CARTAGE	TAX AMOUNT	DOCUMENT TOTAL
		<i>Jose</i>				54.29		5.02	59.31

THE UNDERSIGNED AGREES TO THE ADDITIONAL TERMS AND CONDITIONS ON THE REVERSE SIDE.
BY *Jose*

FOR MORE INFORMATION REGARDING HAZARDOUS MATERIAL, PLEASE REFER TO THE REVERSE SIDE. THE ABOVE DESCRIBED MATERIAL CHECKED & RECEIVED IN GOOD CONDITION.

MILLING/SPECIAL ORDERED - PLEASE READ UP MATERIAL WITHIN 14 DAYS AFTER NOTIFICATION. CUSTOMER AGREES TO PAY ALL HANDLING CHARGES FOR MATERIALS RETURNED TO SUPPLIER. AND FURTHER AGREES TO PAY ENTIRE PURCHASE PRICE IF MATERIAL CANNOT BE RETURNED.

CUSTOMER AGREES THAT THIS ORDER LISTED ABOVE IS CORRECT IN EVERY DETAIL. IF THIS ORDER IS CANCELLED OR IF CUSTOMER FAILS TO PICK UP MATERIAL WITHIN 14 DAYS AFTER NOTIFICATION, CUSTOMER AGREES TO PAY ALL HANDLING CHARGES FOR MATERIALS RETURNED TO SUPPLIER.

CUSTOMER SIGNATURE: _____ APPROX. DATE REC: _____ DATE NOTIFIED: _____

NON REFUNDABLE: % RETURN CHARGE: _____

ORDERED BY: _____ P.O. _____ APPROX. DATE REC: _____ DATE NOTIFIED: _____

127 OLD TO

Agenda: 4.4.24
Item: 10c

Work Performed by:
Work Performed at the direction of:

ANDERSON PACIFIC ENGINEERING CONSTRUCTION, INC.
San Lorenzo Valley Water District

APEC Job #: **2202**
Date Performed: **1/17/2024**
DEWR #: **PCO-10-05**

Description of Work:

Hand trench downhill @11654 Alta Via, install 1" poly line, backfill

EQUIP. NO.	EQUIPMENT	OT/Delay Factor	HOURS		HOURLY RATE	EXTENDED AMOUNTS	LABOR	HOURS		HOURLY RATE	EXTENDED AMOUNTS
			RT	OT				RT	OT		
1018	FORD F150 PICKUP TRUCK	1	4		\$ 37.61	\$ 150.44	FOREMAN J. Swain	4		\$ 105.82	\$ 423.28
87	GMC SIERRA 1500 PICKUP TRUCK	1			\$ 37.61	-	CONSTRUCTION SPECIALIST M. Johns	8		\$ 71.93	\$ 575.44
7006	FORD F650 BOBTAIL DUMP TRUCK - 5 CY	1			\$ 73.34	-	LABORER 1 F. Flores	8		\$ 71.15	\$ 569.20
3022	KOBELCO SK 45SRX-6E	1			\$ 48.03	-	LAB APP 3 D. Lizola Ramos	4		\$ 63.32	\$ 253.28
0		1			\$ -	-	LABORER 1 T. Etchison	4		\$ 71.15	\$ 284.60
0		1			\$ -	-	LABORER 1	8		\$ 71.15	\$ 569.20
0		1			\$ -	-	LABORER 1 G. Zavala	0		\$ -	\$ -
0		1			\$ -	-		0		\$ -	\$ -
0		1			\$ -	-		0		\$ -	\$ -
0		1			\$ -	-		0		\$ -	\$ -
0		1			\$ -	-		0		\$ -	\$ -
0		1			\$ -	-		0		\$ -	\$ -
0		1			\$ -	-		0		\$ -	\$ -
0		1			\$ -	-		0		\$ -	\$ -
0		1			\$ -	-		0		\$ -	\$ -
MATERIAL and/or TRUCKING											
Description		No. Units			Unit Cost	Amount					
Material	Iconix- U2416001918	1.00	LS		\$462.37	\$462.37			INCLUDED		\$ 2,675.00
Material	Scarborough Lumber- 419078/2	1.00	LS		\$75.96	\$75.96					\$ -
Material	Scarborough Lumber- 628363/5	1.00	LS		\$37.80	\$37.80			INCLUDED		\$ -
		1.00	LS		\$0.00	\$0.00					\$ -
		1.00	LS		\$0.00	\$0.00					\$ -
WORK DONE BY SUBCONTRACTOR and/or SPECIALISTS											
Description		No. Units			Unit Cost	Amount					
		1.00	LS		\$0.00	\$0.00					\$ -
		1.00	LS		\$0.00	\$0.00					\$ -
		1.00	LS		\$0.00	\$0.00					\$ -
TOTAL COST OF EQUIPMENT, MATERIALS AND TRUCKING											
TOTAL COST OF SUBCONTRACTOR AND SPECIALISTS											
TOTAL THIS REPORT											
											\$ 2,675.00
											\$ 726.57
											\$ -
											\$ 347.75
											\$ 72.66
											\$ -
											\$ 3,821.98

13% MARK-UP ON LABOR COST
10% MARK-UP ON EQUIPMENT, MATERIALS AND TRUCKING COST
7% MARK-UP ON SUBCONTRACTOR AND SPECIALISTS COST

ANDERSON PACIFIC

Engineering Construction, Inc.

BILLING INFORMATION:

NAME: Anderson Pacific
 ADDRESS: 1370 NORMAN AVE
 CITY/STATE/ZIP: SANTA CLARA, CA
 PHONE: 408.970.9900

129

DAILY EXTRA WORK REPORT

DATE PERFORMED 1/17/2024

WORK PERFORMED AT THE DIRECTION OF: SAN LORENZO WATER DISTRICT CONTRACTOR JOB NO. 2202

DESCRIPTION OF WORK: HAND TRENCH DOWNHILL @ 11654 ALTA VIA CONTRACTOR REPORT NO. _____

INSTALL 1" POLY LINE - BACKFILL

EQUIP NO.	EQUIPMENT	HOURS	HOURLY/DAILY RATE	EXTENDED AMOUNTS	P.R. NO.	LABOR	HOURS	HOURLY RATE	EXTENDED AMOUNTS
1018	Folds F-150	4			L1	FRANCISCO ANICA FLORES	REG. 8 O.T.		
					L1	GUILERMO ZAVALA	REG. 8 O.T.		
					CS	MIKE JOHN S	REG. 8 O.T.		
					F	JOE SWAIN	REG. 4 O.T.		
					LA3	DANIEL DAMOS	REG. 4 O.T.		
					LI	TIM ERNISON	REG. 4 O.T.		

MATERIAL AND/OR WORK DONE BY SPECIALISTS			EXTENDED
DESCRIPTION	NO. UNIT	UNIT COST	EXTENDED
TECNIX - UTA 16001918 - comp/lms			
SAN LORENZO WATER - 419 0718/2 - supplies / carrying			
SAN LORENZO WATER - 628043/5 - bushings, elbows,			
CONTRACTOR - #337854 - 1/2 poly			
TOTAL COST OF EQUIPMENT, MATERIALS AND WORK			A

PAYROLL BURDEN AND/OR MARKUPS		EXTENDED
		EXTENDED
TOTAL COST OF LABOR		B
TOTAL A & B		
MARKUP ON EQUIPMENT, MATERIAL AND WORK COST _____ %		
TOTAL THIS REPORT		

ACCEPTED: _____
 CONTRACTOR'S REPRESENTATIVE

OWNER/AGENT _____

WJL

ICONIX Waterworks (US) Inc.
 1359 DAYTON ST BLDG A
 Salinas, CA 93901-4404
 USA
 Tel: 831-757-7776
 Fax: 831-757-7832
 www.iconixww.com

INVOICE



Invoice Number: U2416001918
Invoice Date: 01/18/24
Page: 1

RECEIVED
 JAN 19 2024
APEC

Bill To: ANDERSON PACIFIC
 1370 NORMAN AVENUE
 SANTA CLARA, CA 95054
 USA

Ship To: ICONIX Waterworks (US) Inc.
 1359 DAYTON ST BLDG A
 SALINAS, CA 93901-4404
 USA

Cust No.	ANDPAC	Ship Via		P.O. Date	01/17/24
Terms	Net 30 daysA	Ship Date	01/17/24	P.O. Number	2202
Due Date	02/17/24	SalesPerson	Chad Tackel	Our Order No.	U2412002132
PST Exempt No.		Creator	SALNSPOS2	Cust Job Name	BOULDER CREEK
GST Exempt No.		Posted By	LDAVILA	Ordered By:	DANIEL

Item No.	Customer Item	Description	Unit	Order Qty	Quantity	Unit Price	Total Price
WWC8444GNL		1 FORD MIP X GJ CTS CPLG NL	EACH	14	14	30.23	423.22

Taxable Amount	Tax Exempt Amount	Subtotal:	423.22
423.22	0.00	Invoice Discount:	0.00
		Total Sales Tax:	39.15
		Total:	462.37

Please remit payment to: ICONIX Waterworks (US) Inc.
PO BOX 1516
SNOHOMISH, WA 98291
USA

Interest is charged at 2% per month on all overdue amounts

DELIVERY TIMES AND PRICING FOR ALL GOODS AND SERVICES ORDERED HEREIN ARE SUBJECT TO CHANGE. PAYMENT TERMS FOR ALL GOODS AND SERVICES WILL BE NET 30 DAYS FROM THE INVOICE DATE. INTEREST IS CHARGED AT 2% ON ALL OVERDUE AMOUNTS. ANY GOODS OR SERVICES PROVIDED BY ICONIX WILL BE SUBJECT TO A LIMITED WARRANTY PROVIDED THAT WHERE ICONIX IS NOT THE MANUFACTURER OF GOODS. CUSTOMER'S SOLE RECOURSE FOR DEFECTIVE GOODS WILL BE TO THE MANUFACTURER'S EXPRESS WARRANTY, IF ANY. EXCEPT AS OTHERWISE SET OUT HEREIN ALL GOODS AND SERVICES DESCRIBED HEREIN WILL BE PROVIDED SUBJECT TO ICONIX'S TERMS AND CONDITIONS WHICH SHALL SUPERSEDE AND TAKE PRECEDENCE OVER ANY OTHER TERMS AND CONDITIONS. THE ICONIX SALE TERMS AND CONDITIONS ARE AVAILABLE ON REQUEST OR ONLINE AT WWW.ICONIXWW.COM/UNITED-STATES/TERMS-AND-CONDITIONS-OF-SALE/

ICONIX Waterworks (US) Inc.

1359 DAYTON ST BLDG A
Salinas, CA 93901-4404
USA
Tel: 831-757-7776
Fax: 831-757-7832
www.iconixww.com

SALES SHIPMENT

COPY



Shipment Number: U2414002072

Shipment Date: 01/17/24

Page: 1

Bill To: ANDERSON PACIFIC
1370 NORMAN AVENUE
SANTA CLARA, CA 95054
USA
Tel: 408-970-9900

Ship To: ICONIX Waterworks (US) Inc.
1359 DAYTON ST BLDG A
SALINAS, CA 93901-4404
USA

Customer ID	ANDPAC	SalesPerson	Chad Tackel	P.O. Date	01/17/24
Ship Via	Customer Pickup	Sales Tel No.	831-737-5310	P.O. Number	2202
Ordered By	DANIEL	Inside Sales	Bill Nichols	Our Order No.	U2412002132
Shipping Payment Type	Freight Collect	Creator	SALNSPOS2	Cust Job No.	BOULDER CREEK
Ship. Agent Svc	WILLCALL	Posted By	SALNSPOS2	Job Desc	
Bill of Lading No.					

Item No.	Customer Item	Description	Unit	Ship Weight	Ordered	Shipped	Back Ordered
WWC8444GNL		1 FORD MIP X GJ CTS CPLG NL	EACH	12.10	14	14	

Qty 9909

Ship Weight: 12.10 (Pounds) 5.50 (KGs)

RECEIVED BY: _____
(PRINT NAME)

(SIGN HERE)

DATE: _____

DELIVERY TIMES AND PRICING FOR ALL GOODS AND SERVICES ORDERED HEREIN ARE SUBJECT TO CHANGE. PAYMENT TERMS FOR ALL GOODS AND SERVICES WILL BE NET 30 DAYS FROM THE INVOICE DATE. INTEREST IS CHARGED AT 2% ON ALL OVERDUE AMOUNTS. ANY GOODS OR SERVICES PROVIDED BY ICONIX WILL BE SUBJECT TO A LIMITED WARRANTY PROVIDED THAT WHERE ICONIX IS NOT THE MANUFACTURER OF GOODS, CUSTOMER'S SOLE RECOURSE FOR DEFECTIVE GOODS WILL BE TO THE MANUFACTURER'S EXPRESS WARRANTY, IF ANY. EXCEPT AS OTHERWISE SET OUT HEREIN, ALL GOODS AND SERVICES DESCRIBED HEREIN WILL BE PROVIDED SUBJECT TO ICONIX'S TERMS AND CONDITIONS WHICH SHALL SUPERSEDE AND TAKE PRECEDENCE OVER ANY OTHER TERMS AND CONDITIONS. THE ICONIX SALE TERMS AND CONDITIONS ARE AVAILABLE ON REQUEST OR ONLINE AT ICONIXWWW.COM/UNITED-STATES/TERMS-AND-CONDITIONS-OF-SALE/

SCARBOROUGH HOME CENTER, INC.
9470 HIGHWAY 9, BEN LOMOND 95005
MAIL: P.O. BOX 66599
SCOTT'S VALLEY, CA 95067
PHONE: (831) 336-5142

30 DAYS** + RECEIPT REQUIRED ON
 ALL RETURNS / EXCHANGES

132

Customer No. 12617	Job No. 2202	Purchase Order No. 2202	Reference BROOKDALE	Terms 1% 10TH, NET 11TH,	Clerk DEH	Date 1/17/24	Time 2:21
-----------------------	-----------------	----------------------------	------------------------	-----------------------------	--------------	-----------------	--------------

Sold To
 * ANDERSON PACIFIC ENGINEERING
 1370 NORMAN AVE.
 SANTA CLARA, CA 95054
 (408) 970-9900

Ship To

DOC# 419078/2

 * INVOICE *

 SLSPR: 00 DEFAULT
 TAX : 200 SALES TAX: S CRUZ COU

TERM#567

SHIPPED	ORDERED	UM	SKU	DESCRIPTION	UNITS	PRICE/PER	EXTENSION
1		EA	4124376	NIPPLE GALV 3/4"x8"	1	4.99 /EA	4.99
1		EA	4124285	NIPPLE GALV 3/4"x5.5"	1	3.79 /EA	3.79
1		EA	406151	3/4"DRESSER COUPLING	1	61.79 /EA	61.79 *

9969
See

67

** AMOUNT CHARGED TO STORE ACCOUNT **
 (GOMEZ, JOSE)

TAXABLE	70.57
NON-TAXABLE	0.00
SUBTOTAL	70.57
TD DISCOUNT	-0.88
TAX AMOUNT	6.27
TOTAL AMOUNT	75.96

X
Asi Gomez

Received By

SCARBOROUGH BUILDING SUPPLY
12990 HWY 9, BOULDER CREEK
MAIL: P.O. BOX 66599
SCOTT'S VALLEY, CA 95067
PHONE: (831) 338-6467

30 DAYS** + RECEIPT REQUIRED ON
 ALL RETURNS / EXCHANGES

133

Customer No. 12617	Job No.	Purchase Order No. 2202	Reference BROOKDALE	Terms 1% 10TH, NET 11TH,	Clerk ELM	Date 1/17/24	Time 9:20
-----------------------	---------	----------------------------	------------------------	-----------------------------	--------------	-----------------	--------------

Sold To
 * ANDERSON PACIFIC ENGINEERING
 1370 NORMAN AVE.
 SANTA CLARA, CA 95054
 (408) 970-9900

Ship To

DOC# 628363/5

 * INVOICE *

 TERM#582
 SLSPR: 00 DEFAULT
 TAX : 500 SALES TAX: S CRUZ COU

SHIPPED	ORDERED	UM	SKU	DESCRIPTION	UNITS	PRICE/PER	EXTENSION
2		EA	47769	90 DEG ELBOW GALV 1X1"	2	4.79 /EA	9.58
1		EA	47810	HEX BUSHINGS 1X3/4" GLV	1	4.99 /EA	4.99
2		EA	47778	ELBOW GLV 1" 90 DEG ST	2	4.99 /EA	9.98
2		EA	4066452	ELBOW 45DEG 1"GALV	2	6.99 /EA	13.98

83	** AMOUNT CHARGED TO STORE ACCOUNT **	37.80	TAXABLE	38.53
	(GOMEZ, JOSE)		NON-TAXABLE	0.00
			SUBTOTAL	38.53
			TD DISCOUNT	-3.85
			TAX AMOUNT	3.12
			TOTAL AMOUNT	37.80

X *José Gomez*
 Received By

Work Performed by:
Work Performed at the direction of:

Description of Work: Trench for 2" hot tap, saddle, gate valve on street approx. 150' NE of 12030 Alta Via; trench approx. 40' downhill

EQUIP. NO.	EQUIPMENT	OT/Delay Factor	HOURS		HOURLY RATE	EXTENDED AMOUNTS	LABOR	HOURS		HOURLY RATE	EXTENDED AMOUNTS
			RT	OT				RT	OT		
1018	FORD F150 PICKUP TRUCK	1	RT	4	\$ 37.61	\$ 150.44	FOREMAN	RT	4	\$ 105.82	\$ 423.28
87	GMC SIERRA 1500 PICKUP TRUCK	1	RT		\$ -	\$ -	J. Swain	OT		\$ -	\$ -
7006	FORD F650 BOBTAIL DUMP TRUCK - 5 CY	1	RT	4	\$ 73.34	\$ 293.36	OPERATOR 3	RT	4	\$ 99.79	\$ 399.16
3022	KOBELCO SK 45SRX-6E	1	RT	4	\$ 48.03	\$ 192.12	T. Thurman	OT		\$ -	\$ -
0		1	RT	4	\$ -	\$ -	LABORER 1	RT	4	\$ 71.15	\$ 284.60
0		1	OT		\$ -	\$ -	F. Flores	OT		\$ -	\$ -
0		1	RT	4	\$ -	\$ -	LAB APP 3	RT	4	\$ 63.32	\$ 253.28
0		1	OT		\$ -	\$ -	D. Lizaola Ramos	OT		\$ -	\$ -
0		1	RT	4	\$ -	\$ -	LABORER 1	RT	4	\$ 71.15	\$ 284.60
0		1	OT		\$ -	\$ -	T. Etchison	OT		\$ -	\$ -
0		1	RT	4	\$ -	\$ -	LABORER 1	RT	4	\$ 71.15	\$ 284.60
0		1	OT		\$ -	\$ -	G. Zavala	OT		\$ -	\$ -
0		1	RT	4	\$ -	\$ -	0	RT	4	\$ -	\$ -
0		1	OT		\$ -	\$ -	0	OT		\$ -	\$ -
0		1	RT	4	\$ -	\$ -	0	RT	4	\$ -	\$ -
0		1	OT		\$ -	\$ -	0	OT		\$ -	\$ -
0		1	RT	4	\$ -	\$ -	0	RT	4	\$ -	\$ -
0		1	OT		\$ -	\$ -	0	OT		\$ -	\$ -
0		1	RT	4	\$ -	\$ -	0	RT	4	\$ -	\$ -
0		1	OT		\$ -	\$ -	0	OT		\$ -	\$ -
MATERIAL and/or TRUCKING											
Description	No. Units	Unit Cost	Amount								
	1.00 LS	\$0.00	\$0.00								
	1.00 LS	\$0.00	\$0.00								
	1.00 LS	\$0.00	\$0.00								
	1.00 LS	\$0.00	\$0.00								
WORK DONE BY SUBCONTRACTOR and/or SPECIALISTS											
Description	No. Units	Unit Cost	Amount								
	1.00 LS	\$0.00	\$0.00								
	1.00 LS	\$0.00	\$0.00								
	1.00 LS	\$0.00	\$0.00								
TOTAL COST OF EQUIPMENT, MATERIALS AND TRUCKING											
TOTAL COST OF SUBCONTRACTOR AND SPECIALISTS											
											\$ 1,360.32
											\$ 635.92
											\$ -
											\$ 176.84
											\$ 63.59
											\$ -
TOTAL THIS REPORT											\$ 2,236.67

13% MARK-UP ON LABOR COST
10% MARK-UP ON EQUIPMENT, MATERIALS AND TRUCKING COST
7% MARK-UP ON SUBCONTRACTOR AND SPECIALISTS COST

Description of Work: Finish excavation for 2" hot tap/ saddle/ gate valve; install saddle/ gate valve and approx. 40' of poly tube; set trench plates and cold mix

EQUIP. NO.	EQUIPMENT	OT/Delay Factor	HOURS		HOURLY RATE	EXTENDED AMOUNTS	LABOR	HOURS		HOURLY RATE	EXTENDED AMOUNTS
			RT	OT				RT	OT		
1018	FORD F150 PICKUP TRUCK	1	8		\$ 37.61	\$ 300.88	FOREMAN J. Swain	8		\$ 105.82	\$ 846.56
1020	FORD F250 CREW TRUCK - UTILITY	1	2		\$ 42.39	\$ 84.78	OPERATOR 3 T. Thurman	8		\$ 99.79	\$ 798.32
7006	FORD F650 BOBTAIL DUMP TRUCK - 5 CY	1	4		\$ 73.34	\$ 293.36	TEAMSTER 1 J. Ramos	4		\$ 76.50	\$ 306.00
3022	KOBELCO SK 45SRX-6E	1	8		\$ 48.03	\$ 384.24	LAB APP 3 D. Lizaola Ramos	8		\$ 63.32	\$ -
0		1			\$ -	\$ -	LABORER 1 T. Etchison	5		\$ 71.15	\$ 355.75
0		1			\$ -	\$ -	CONSTRUCTION SPECIA A. Flores	8		\$ 71.93	\$ 575.44
0		1			\$ -	\$ -	CONSTRUCTION SPECIA J. Gomez	2		\$ 71.93	\$ 143.86
0		1			\$ -	\$ -	0		\$ -	\$ -	\$ -
0		1			\$ -	\$ -	0		\$ -	\$ -	\$ -
0		1			\$ -	\$ -	0		\$ -	\$ -	\$ -
0		1			\$ -	\$ -	0		\$ -	\$ -	\$ -
0		1			\$ -	\$ -	0		\$ -	\$ -	\$ -
0		1			\$ -	\$ -	0		\$ -	\$ -	\$ -
MATERIAL and/or TRUCKING											
Description	No. Units	Unit Cost		Amount							
Material	1.00 LS	\$40.24		\$40.24							
Material	1.00 LS	\$73.41		\$73.41							
	1.00 LS	\$0.00		\$0.00							
	1.00 LS	\$0.00		\$0.00							
WORK DONE BY SUBCONTRACTOR and/or SPECIALISTS											
Description	No. Units	Unit Cost		Amount							
	1.00 LS	\$0.00		\$0.00							
	1.00 LS	\$0.00		\$0.00							
	1.00 LS	\$0.00		\$0.00							
TOTAL COST OF LABOR											
											\$ 3,025.93
Sub-Total Labor RT											\$ -
Labor Surcharge RT											\$ -
Sub-Total Labor OT											\$ -
Labor Surcharge OT											\$ -
Subsistence											\$ -
TOTAL COST OF EQUIPMENT, MATERIALS AND TRUCKING											
											\$ 3,025.93
TOTAL COST OF SUBCONTRACTOR AND SPECIALISTS											
											\$ 1,176.91
TOTAL THIS REPORT											
											\$ 4,713.90

13% MARK-UP ON LABOR COST
10% MARK-UP ON EQUIPMENT, MATERIALS AND TRUCKING COST
7% MARK-UP ON SUBCONTRACTOR AND SPECIALISTS COST

ANDERSON PACIFIC

Engineering Construction, Inc.

BILLING INFORMATION:
 NAME: ANDERSON PACIFIC
 ADDRESS: 137B NORWOOD AVE
 CITY/STATE/ZIP: CAJITA CLAY, CA
 PHONE: 408.970.9900

136

DAILY EXTRA WORK REPORT

DATE PERFORMED 1/18/2024

WORK PERFORMED AT THE DIRECTION OF: SAN LORENZO WATER DISTRICT

2202

DESCRIPTION OF WORK: FINISH EXCAVATION FOR 2" HOT TAP/SADDLE/GATE VALVE
INSTALL SADDLE/GATE VALVE AND APPROX 40' OF POLY PIPE - SET TRENCH PLATE/COLD MIX

CONTRACTOR JOB NO. _____
 CONTRACTOR REPORT NO. _____

EQUIP NO.	EQUIPMENT	HOURS	HOURLY/DAILY RATE	EXTENDED AMOUNTS	P.R. NO.	LABOR	HOURS	HOURLY RATE	EXTENDED AMOUNTS
1018	FORD F150	8			F	JOE SWAIN	REG. 8		
3022	KOBELCO MINI	8					O.T.		
7006	DUMP TRUCK	4			03	TOMMY THURMAN	REG. 8		
	HONDA GENERATOR	4			11	(TOMMY) FLOY RAMOS	O.T.		
	PORT HAMMER	2			05	AJA FLORES	REG. 2		
	PORT UTILITY TRUCK				11	TIM ETALISON	O.T.		
					05	JOSÉ GOMEZ	REG. 2		
							O.T.		
							REG.		
							O.T.		
							REG.		
							O.T.		

MATERIAL AND/OR WORK DONE BY SPECIALISTS		SUB-TOTAL	
DESCRIPTION	NO. UNIT	UNIT COST	EXTENDED
<u>Screening Lumber - 4/9/12/2 - Nipley, elbow, bushing</u>			
<u>Screening Lumber - 4/9/11/2 - Nipley, elbow, caplock, base</u>			
TOTAL COST OF EQUIPMENT, MATERIALS AND WORK			
TOTAL COST OF LABOR			A
TOTAL A & B			B

ACCEPTED: _____ CONTRACTOR'S REPRESENTATIVE

OWNER/AGENT _____

MARKUP ON EQUIPMENT, MATERIAL AND WORK COST _____ %

TOTAL THIS REPORT

SCARBOROUGH HOME CENTER, INC.
9470 HIGHWAY 9, BEN LOMOND 95005
MAIL: P.O. BOX 66599
SCOTT'S VALLEY, CA 95067
PHONE: (831) 336-5142

30 DAYS** + RECEIPT REQUIRED ON
 ALL RETURNS / EXCHANGES

137

Customer No. 12617	Job No.	Purchase Order No. 2202	Reference BROOKDALE	Terms 1 & 10TH, NET 11TH,	Clerk CTB	Date 1/18/24	Time 10:17
-----------------------	---------	----------------------------	------------------------	------------------------------	--------------	-----------------	---------------

Sold To
 * ANDERSON PACIFIC ENGINEERING
 1370 NORMAN AVE.
 SANTA CLARA, CA 95054
 (408) 970-9900

Ship To

DOC# 419112/2

 * INVOICE *

 TERM#568
 SLSPR: 00 DEFAULT
 TAX : 200 SALES TAX: S CRUZ COU

SHIPPED	ORDERED	UM	SKU	DESCRIPTION	UNITS	PRICE/PER	EXTENSION
1		EA	4124756	NIPPLE GALV 1"X10"	1	7.99 /EA	7.99
1		EA	4124780	NIPPLE GALV 1"X12"	1	8.99 /EA	8.99
2		EA	47769	90 DEG ELBOW GALV 1X1"	2	4.79 /EA	9.58
1		EA	4124558	NIPPLE GALV 1"X4"	1	2.99 /EA	2.99
1		EA	4124574	NIPPLE GALV 1"X5"	1	3.99 /EA	3.99
1		EA	4124160	NIPPLE GALV 3/4"X2"	1	2.49 /EA	2.49
1		EA	47810	HEX BUSHINGS 1X3/4" GLV	1	4.99 /EA	4.99

** AMOUNT CHARGED TO STORE ACCOUNT **		40.24	TAXABLE	41.02
(GOMEZ, JOSE)			NON-TAXABLE	0.00
			SUBTOTAL	41.02
			TD DISCOUNT	-4.10
			TAX AMOUNT	3.32
			TOTAL AMOUNT	40.24

Josie Gomez

X

Received By

SCARBOROUGH HOME CENTER, INC.
9470 HIGHWAY 9, BEN LOMOND 95005
MAIL: P.O. BOX 66599
SCOTT'S VALLEY, CA 95067
PHONE: (831) 336-5142

30 DAYS** + RECEIPT REQUIRED ON
 ALL RETURNS / EXCHANGES

Customer No. 12617	Job No.	Purchase Order No. 2202	Reference BROOKDALE	Terms 1% 10TH, NET 11TH,	Clerk CTB	Date 1/18/24	Time 3:28
-----------------------	---------	----------------------------	------------------------	-----------------------------	--------------	-----------------	--------------

Sold To
 * ANDERSON PACIFIC ENGINEERING
 1370 NORMAN AVE.
 SANTA CLARA, CA 95054
 (408) 970-9900

Ship To

DOC# 419141/2

 * INVOICE *

 TERM#568
 SLSPR: 00 DEFAULT
 TAX : 200 SALES TAX: S CRUZ COU

SHIPPED	ORDERED	UM	SKU	DESCRIPTION	UNITS	PRICE/PER	EXTENSION
1		EA	41644	GALV NIPPLE 1X9	1	9.99 /EA	9.99 *
1		EA	4124780	NIPPLE GALV 1 "X12"	1	8.99 /EA	8.99
1		EA	4124699	NIPPLE GALV 1 "X6"	1	4.99 /EA	4.99
1		EA	47815	UNION GLV IRON 1X1"	1	17.99 /EA	17.99
1		EA	4067385	HEX BUSHING GLV 2X1"	1	8.99 /EA	8.99
1		EA	47769	90 DEG ELBOW GALV 1X1"	1	4.79 /EA	4.79
1		EA	47783	TEE GLV 1X1X1"	1	7.99 /EA	7.99
1		EA	47833	COUPLNG GLV 2X2"	1	9.99 /EA	9.99

37	** AMOUNT CHARGED TO STORE ACCOUNT **	73.41	TAXABLE	73.72
	(GOMEZ, JOSE)		NON-TAXABLE	0.00
			SUBTOTAL	73.72
			TD DISCOUNT	-6.37
			TAX AMOUNT	6.06
			TOTAL AMOUNT	73.41

Jose Gomez

X

Received By

Description of Work: Backfill water meter trenches

EQUIP. NO.	EQUIPMENT	OT/Delay Factor	HOURS		HOURLY RATE	EXTENDED AMOUNTS	LABOR		HOURS	HOURLY RATE	EXTENDED AMOUNTS
			RT	OT			LABORER	OT			
1018	FORD F150 PICKUP TRUCK	1	RT	OT	\$ 37.61	\$ -	49	FOREMAN	RT	\$ 105.82	\$ -
					\$ -	\$ -		J. Swain	OT	\$ -	\$ -
87	GMC SIERRA 1500 PICKUP TRUCK	1	RT	OT	\$ 37.61	\$ -	1	LABORER 1	RT	\$ 71.15	\$ 355.75
					\$ -	\$ -		F. Flores	OT	\$ -	\$ -
7006	FORD F650 BOBTAIL DUMP TRUCK - 5 CY	1	RT	OT	\$ 73.34	\$ -	1	LABORER 1	RT	\$ 71.15	\$ 355.75
					\$ -	\$ -		M. Johns	OT	\$ -	\$ -
3022	KOBELCO SK 45SRX-6E	1	RT	OT	\$ 48.03	\$ -	LA3	LAB APP 3	RT	\$ 63.32	\$ 316.60
					\$ -	\$ -		D. Lizaola Ramos	OT	\$ -	\$ -
0		1	RT	OT	\$ -	\$ -	1	LABORER 1	RT	\$ 71.15	\$ -
					\$ -	\$ -		T. Etchison	OT	\$ -	\$ -
0		1	RT	OT	\$ -	\$ -	1	LABORER 1	RT	\$ 71.15	\$ 355.75
					\$ -	\$ -		G. Zavala	OT	\$ -	\$ -
0		1	RT	OT	\$ -	\$ -		0	RT	\$ -	\$ -
					\$ -	\$ -		0	OT	\$ -	\$ -
0		1	RT	OT	\$ -	\$ -		0	RT	\$ -	\$ -
					\$ -	\$ -		0	OT	\$ -	\$ -
0		1	RT	OT	\$ -	\$ -		0	RT	\$ -	\$ -
					\$ -	\$ -		0	OT	\$ -	\$ -
0		1	RT	OT	\$ -	\$ -		0	RT	\$ -	\$ -
					\$ -	\$ -		0	OT	\$ -	\$ -
MATERIAL and/or TRUCKING											
Description	No. Units	Unit Cost	Amount								
Material	1.00 LS	\$71.98	\$71.98		INCLUDED						
	1.00 LS	\$0.00	\$0.00								
	1.00 LS	\$0.00	\$0.00		INCLUDED						
	1.00 LS	\$0.00	\$0.00								
	1.00 LS	\$0.00	\$0.00								
WORK DONE BY SUBCONTRACTOR and/or SPECIALISTS											
Description	No. Units	Unit Cost	Amount								
	1.00 LS	\$0.00	\$0.00								
	1.00 LS	\$0.00	\$0.00								
	1.00 LS	\$0.00	\$0.00								
TOTAL COST OF LABOR											
											\$ 1,383.85
Sub-Total Labor RT											\$ -
Labor Surcharge RT											\$ -
Sub-Total Labor OT											\$ -
Labor Surcharge OT											\$ -
Subsistence											\$ -
TOTAL COST OF EQUIPMENT, MATERIALS AND TRUCKING											
											\$ 179.90
TOTAL COST OF SUBCONTRACTOR AND SPECIALISTS											
											\$ 7.20
TOTAL THIS REPORT											
											\$ 1,642.93

13% MARK-UP ON LABOR COST
10% MARK-UP ON EQUIPMENT, MATERIALS AND TRUCKING COST
7% MARK-UP ON SUBCONTRACTOR AND SPECIALISTS COST

ANDERSON PACIFIC

Engineering Construction, Inc.

BILLING INFORMATION:

NAME: Anderson Pacific
 ADDRESS: 1390 NORMAN AVE
 CITY/STATE/ZIP: SANTA CLARITA CA
 PHONE: 408.970.9900

140

DAILY EXTRA WORK REPORT

DATE PERFORMED: 1/18/2024
 WORK PERFORMED AT THE DIRECTION OF: SAN LORENZO WATER DISTRICT

CONTRACTOR JOB NO. 2202

CONTRACTOR REPORT NO.

DESCRIPTION OF WORK: Buckfill WATER METER TRENCHES

EQUIP NO.	EQUIPMENT	HOURS	HOURLY/DAILY RATE	EXTENDED AMOUNTS	P.R. NO.	LABOR	HOURS	HOURLY RATE	EXTENDED AMOUNTS	MATERIAL AND/OR WORK DONE BY SPECIALISTS	
										NO. UNIT	UNIT COST
					LI	FRANCISCO ANIKA FLORES	REG. 5				
					LI	MIKE JOHNS	REG. 5				
					LI	GUILLERMO ZAVALLA	REG. 5				
					LI	DANIEL RAMOS	REG. 5				
							O.T.				
							REG.				
							O.T.				
							REG.				
							O.T.				
							REG.				
							O.T.				
										SUB-TOTAL	
										PAYROLL BURDEN AND/OR MARKUPS	
										TOTAL COST OF LABOR	
										A	
										B	
										TOTAL A & B	
										MARKUP ON EQUIPMENT, MATERIAL AND WORK COST _____%	
										TOTAL THIS REPORT	

CONTRACTOR'S REPRESENTATIVE

ACCEPTED:

OWNER/AGENT

INVOICE



PLEASE MAIL REMITTANCE TO:

Granite Construction Company
PO Box 742478
Los Angeles, CA 90074-2478

INVOICE DATE: 1/18/2024

Bill To:

ANDERSON PACIFIC ENGINEERING CONSTRUCT
1370 NORMAN AVENUE
SANTA CLARA CA 95054-2056
AP@ANDPAC.COM

ORDER NO.	CUSTOMER NO.	PLANT	INVOICE NO.
282857	120862	FELTON RAP 100323	2842611
ORIGINAL INVOICE #		JOB ADDRESS	DATE OF SALE
		SLVWD ALTA VIA PIPELINE REPLACEMENT ALTA VIA BROOKDALE CA 95007	1/18/2024
			PO #
			2202

A LATE FEE OF 1.5% PER MONTH (18% PER ANNUM) WILL BE APPLIED ON PAST DUE BALANCES

A CREDIT CARD FEE OF 2.3% WILL BE APPLIED TO ALL CREDIT CARD PAYMENTS MADE MORE THAN 10 BUSINESS DAYS AFTER THE INVOICE DATE ABOVE

TICKET NUMBER	TICKET DATE	MATERIAL DESCRIPTION	QTY	UNIT PRICE	EXTENDED AMOUNT	FOB	TAX RATE AREA
31634460	1/18/2024	1823 - 3/4"RECYCLED AGGREGATE BASE	5.080 TN	13.000	\$66.04	P	V050870000
TOTAL:		1823 - 3/4"RECYCLED AGGREGATE BASE	5.080 TN		\$66.04		

RECEIVED
JAN 22 2024
APEC

TERMS: A/R Net 30 Days

The prevailing party shall be entitled to reasonable attorney's fees and costs in any action to collect the amounts due hereunder.
Note: If haul charges are indicated separately above, then the title passage of materials is at the plant, with delivery provided for customers.
The environmental fee is not a tax, surcharge, or fee mandated by or remitted to any governmental or regulatory agency but used to recover direct and indirect costs for Granite and its subsidiaries operations to be conducted in an environmentally sustainable manner.
For any question regarding this billing, please call (831)768-4002.

TOTAL FREIGHT	.00
MATERIAL	66.04
FEES	.00
SALES TAX	5.94

FOB: P=PLANT J=JOB

FOR OFFICIAL USE ONLY

INVOICE TOTAL

WARNING: THIS PRODUCT CONTAINS A CHEMICAL KNOWN TO THE STATE OF CALIFORNIA TO CAUSE CANCER, BIRTH DEFECTS OR OTHER REPRODUCTIVE HARM. MSDS SHEETS AVAILABLE AT WWW.GRANITECONSTRUCTION.COM/MSDS OR BY CONTACTING YOUR LOCAL OFFICE.

\$71.98

Description of Work: Additional erosion control for cross country section

EQUIP. NO.	EQUIPMENT	OT/Delay Factor	HOURS		HOURLY RATE	EXTENDED AMOUNTS	LABOR		HOURS	HOURLY RATE	EXTENDED AMOUNTS
			RT	OT			LABORER	OT			
1018	FORD F150 PICKUP TRUCK	1	RT	OT	\$ 37.61	\$ -	LABORER 1 Jesus Ramos	RT	3	\$ 71.15	\$ 213.45
87	GMC SIERRA 1500 PICKUP TRUCK	1	RT	OT	\$ 37.61	\$ -	LABORER 1 G. Zavala	RT	3	\$ 71.15	\$ 213.45
7006	FORD F650 BOBTAIL DUMP TRUCK - 5 CY	1	RT	OT	\$ 73.34	\$ -	LABORER 1 M. Johns	RT	3	\$ 71.15	\$ 213.45
3022	KOBELCO SK 45SRX-6E	1	RT	OT	\$ 48.03	\$ -	LAB APP 3 D. Lizaola Ramos	RT	3	\$ 63.32	\$ 189.96
0		1	RT	OT	\$ -	\$ -	LABORER 1 T. Etchison	RT	3	\$ 71.15	\$ 213.45
0		1	RT	OT	\$ -	\$ -	LABORER 1 F. Flores	RT	3	\$ 71.15	\$ 213.45
0		1	RT	OT	\$ -	\$ -		RT		\$ -	\$ -
0		1	RT	OT	\$ -	\$ -		RT		\$ -	\$ -
0		1	RT	OT	\$ -	\$ -		RT		\$ -	\$ -
0		1	RT	OT	\$ -	\$ -		RT		\$ -	\$ -
0		1	RT	OT	\$ -	\$ -		RT		\$ -	\$ -
0		1	RT	OT	\$ -	\$ -		RT		\$ -	\$ -
0		1	RT	OT	\$ -	\$ -		RT		\$ -	\$ -
0		1	RT	OT	\$ -	\$ -		RT		\$ -	\$ -
MATERIAL and/or TRUCKING											
Description		No. Units			Unit Cost	Amount					
Material	San Lorenzo Builders- 61-0242178	1.00	LS		\$266.49	\$266.49		INCLUDED			\$ 1,257.21
Material	Reed & Graham- 073579	1.00	LS		\$386.09	\$386.09		INCLUDED			\$ -
		1.00	LS		\$0.00	\$0.00					\$ -
		1.00	LS		\$0.00	\$0.00					\$ -
		1.00	LS		\$0.00	\$0.00					\$ -
WORK DONE BY SUBCONTRACTOR and/or SPECIALISTS											
Description		No. Units			Unit Cost	Amount					
		1.00	LS		\$0.00	\$0.00					\$ -
		1.00	LS		\$0.00	\$0.00					\$ -
		1.00	LS		\$0.00	\$0.00					\$ -
TOTAL COST OF LABOR											\$ 1,257.21
TOTAL COST OF EQUIPMENT, MATERIALS AND TRUCKING											\$ 652.58
TOTAL COST OF SUBCONTRACTOR AND SPECIALISTS											\$ -
13% MARK-UP ON LABOR COST											\$ 163.44
10% MARK-UP ON EQUIPMENT, MATERIALS AND TRUCKING COST											\$ 65.26
7% MARK-UP ON SUBCONTRACTOR AND SPECIALISTS COST											\$ -
TOTAL THIS REPORT											\$ 2,138.49

INVOICE

1002



235 River St
Santa Cruz, CA 95060
Credit Contact: 831-420-2640
Order Contact: 831-335-4423

DELIVER	CUSTOMER NUMBER	JOB NUMBER	DOCUMENT NUMBER	DOCUMENT DATE
N	551913		61-0242117	01/17/24
DUE DATE	SALES CODE	SALES REP	DELIVERY DATE	REFERENCE NUMBER
02/10/24	104	3	01/17/24	2202
PLEASE REMIT TO:				
Builders FirstSource dba San Lorenzo Lumber PO Box 843909 Los Angeles CA 90084-3909				

FELTON
Sold To:

Store: 61

JUNIOR

Job:

ANDERSON PACIFIC ENG CONST INC
1370 NORMAN AVE
SANTA CLARA CA 95054-2056

General Account
2202
BOULDER CREEK

PIECES	DESCRIPTION	SKU #	LINEAR FEET	BOARD SQ. FTG.	PRICE	U/M	EXTENDED AMOUNT				
3	DIXIELINE/SAN LORENZO BUCKET 5G	390662			4.99	EA	14.97				
4	RICE STRAW WATTLE ROLL 9"X25'	711666			31.99	EA	10% 115.16				
1	20X50 4MIL CLR VISQUEEN	411252			59.99	EA	10% 53.99				
<p>RECEIVED FEB 05 2024 APEC</p> <p>169.15 + 17 ----- 183.12</p>											
<p>Thank you for your business! Payment must be received by the <u>10th</u>.</p>											
TOTAL BOARD FT.		TOTAL SQUARE FT.		SUB-TOTAL		CARTAGE		TAX AMOUNT		INVOICE TOTAL	
0		0		184.12		0.00		16.57		200.69	

Customer Purchase Orders will be accepted for tracking purposes only, no additional obligation will be taken by San Lorenzo Lumber. San Lorenzo Lumber's credit terms and terms of sale prevail. ALL INVOICES FOR PURCHASE MADE ON OR BEFORE THE STATEMENT DATE ARE DUE AND PAYABLE ON THE 10TH DAY FOLLOWING THE STATEMENT DATE. A DELINQUENCY CHARGE OF 1 1/2% PER MONTH WILL BE IMPOSED ON BALANCE PAST DUE AS OF THE NEXT CLOSING DATE. CREDITS ALLOWED ON STOCK ITEMS RETURNED SUBJECT TO 15% HANDLING CHARGE. CARTAGE TO YARD. AND CONDITION OF MATERIAL. SPECIAL ORDERS MAY NOT BE RETURNED

8.2565

INVOICE *202*



235 River St
Santa Cruz, CA 95060
Credit Contact: 831-420-2640
Order Contact: 831-335-4423

DELIVER	CUSTOMER NUMBER	JOB NUMBER	DOCUMENT NUMBER	DOCUMENT DATE
N	551913		61-0242178	01/17/24
DUE DATE	SALES CODE	SALES REP	DELIVERY DATE	REFERENCE NUMBER
02/10/24	104	34	01/17/24	2202
PLEASE REMIT TO:				
Builders FirstSource dba San Lorenzo Lumber PO Box 843909 Los Angeles CA 90084-3909				

FELTON
Sold To:

Store: 61 JR

Job:

ANDERSON PACIFIC ENG CONST INC
1370 NORMAN AVE
SANTA CLARA CA 95054-2056

General Account
BOULDER CREEK

PIECES	DESCRIPTION	SKU #	LINEAR FEET	BOARD SQ. FTG.	PRICE	U/M	EXTENDED AMOUNT
1	20X50 6MIL CLR VISQUEEN	411218			84.99	EA	76.49
6	BLACK TOP PATCH COMM GRADE 50#	680158			19.49	EA	116.94
<div style="display: flex; justify-content: space-between; align-items: center;"> <div style="border: 1px solid black; padding: 10px; width: 30%;"> <p style="color: red; font-weight: bold; font-size: 1.2em;">RECEIVED</p> <p style="color: red; font-weight: bold;">FEB 05 2024</p> <p style="color: red; font-weight: bold; font-size: 1.2em;">APEC</p> </div> <div style="width: 30%; text-align: center;"> <p style="font-size: 1.5em; color: blue;">76.49</p> <p style="font-size: 1.5em; color: blue;">+ TX</p> <hr style="width: 50%; margin: 0 auto;"/> <p style="font-size: 1.5em; color: blue;">\$83.37</p> </div> </div>							
<p><i>Thank you for your business!</i></p> <p>Payment must be received by the <u>10th</u>.</p>							
TOTAL BOARD FT.	TOTAL SQUARE FT.	SUB-TOTAL	CARTAGE	TAX AMOUNT	INVOICE TOTAL		
0	0	193.43	0.00	17.41	210.84		

Customer Purchase Orders will be accepted for tracking purposes only, no additional obligation will be taken by San Lorenzo Lumber. San Lorenzo Lumber's credit terms and terms of sale prevail. ALL INVOICES FOR PURCHASE MADE ON OR BEFORE THE STATEMENT DATE ARE DUE AND PAYABLE ON THE 10TH DAY FOLLOWING THE STATEMENT DATE. A DELINQUENCY CHARGE OF 1 1/2% PER MONTH WILL BE IMPOSED ON BALANCE PAST DUE AS OF THE NEXT CLOSING DATE. CREDITS ALLOWED ON STOCK ITEMS RETURNED SUBJECT TO 15% HANDLING CHARGE. CARTAGE TO YARD. AND CONDITION OF MATERIAL. SPECIAL ORDERS MAY NOT BE RETURNED.

8.2579

Please return this portion with your payment.

**REED &
GRAHAM
INC.**

Mail payment to: REED & GRAHAM, INC.
PO BOX 5940
SAN JOSE CA 95150-5940

INVOICE NUMBER: 073579
INVOICE DATE: 01/19/2024
PAYMENT DUE DATE: 02/18/2024
TOTAL DUE THIS INVOICE: \$386.09

CUSTOMER NO.: 001650

ANDERSON PACIFIC ENGINEERING
CONSTRUCTION, INC
1370 NORMAN AVENUE
SANTA CLARA, CA 95054

AMOUNT ENCLOSED: \$

NDL

REED & GRAHAM INC.	ASPHALT MIXES * EMULSIONS * ROAD OILS * TRUCKING RECEIVED JAN 25 2024 APEC	690 SUNOL STREET * SAN JOSE, CALIFORNIA 95126 * TELEPHONE (408) 287-1400 * FAX (408) 294-3696 ANDERSON PACIFIC ENGINEERING CONSTRUCTION, INC 1370 NORMAN AVENUE SANTA CLARA, CA 95054
	INVOICE NO. 073579	PAGE 1 OF 1

CUSTOMER NO.	INVOICE DATE	DATE OF SALE	P.O. NUMBER	OUR EQUIP. #	SALE SITE
001650	01/19/2024	01/18/2024	2202		SJ

JOB: 2202 - 2202

WEIGHT CERTIFICATE NOS.
PS158248

DESCRIPTION	U/M	QUANTITY	UNIT PRICE	EXTENSION
JUTE 4'X225'/100 SY	RL	2.00	107.0000	214.00
STAPLES 6X1X6 9GA "500/BOX"	BOX	1.00	54.0000	54.00
STAPLES 8X1X8 8GA 500/BOX SQUARE HEAD	BOX	1.00	85.0000	85.00

STATE FUEL TAX	EXCISE TAX	SALES TAX	AMOUNT TAXED	TOTAL INVOICE AMOUNT
0.00	0.00	9.3750%	33.09	386.09

ATTORNEY FEES AND INTEREST: If court action be instituted on this invoice, purchaser promises to pay reasonable attorney fees. Interest charged at 1 1/2% per month on all over-due accounts
APR - 18%.

NOTICE: Your attention is directed to Section 1183 (c) California Code of Civil Procedure which requires us to notify you that if bills are not paid in full for labor, services, equipment or materials furnished, or to be furnished, the improved property may be subject to mechanic's liens.

Description of Work: Additional erosion control for cross country section

EQUIP. NO.	EQUIPMENT	OT/Delay Factor	HOURS		HOURLY RATE	EXTENDED AMOUNTS	LABOR	HOURS		HOURLY RATE	EXTENDED AMOUNTS
			RT	OT				RT	OT		
1026	FORD F250 CREW TRUCK - UTILITY	1	4		\$ 42.39	\$ 169.56	FOREMAN	4		\$ 105.82	\$ 423.28
87	GMC SIERRA 1500 PICKUP TRUCK	1			\$ 37.61	-	A. Proost			-	-
7006	FORD F650 BOBTAIL DUMP TRUCK - 5 CY	1			\$ 73.34	-	LABORER 1	4		\$ 71.15	\$ 284.60
3022	KOBELCO SK 45SRX-6E	1			\$ 48.03	-	J. Gomez	4		-	-
0		1			\$ -	-	LABORER 1	4		\$ 71.15	\$ 284.60
0		1			\$ -	-	A. Flores	4		-	-
0		1			\$ -	-	LAB APP 3	4		\$ 63.32	\$ 253.28
0		1			\$ -	-	D. Lizaola Ramos	4		-	-
0		1			\$ -	-	LABORER 1	4		\$ 71.15	\$ 284.60
0		1			\$ -	-	T. Thurman	4		-	-
0		1			\$ -	-	LABORER 1	4		\$ 71.15	\$ 284.60
0		1			\$ -	-	Jesus Ramos	4		-	-
0		1			\$ -	-	LABORER 1	4		\$ 71.15	\$ 284.60
0		1			\$ -	-	G. Zavala	4		-	-
0		1			\$ -	-	LABORER 1	4		\$ 71.15	\$ 284.60
0		1			\$ -	-	F. Flores	4		-	-
0		1			\$ -	-	LABORER 1	4		\$ 71.15	\$ 284.60
0		1			\$ -	-	T. Etchison	4		-	-
0		1			\$ -	-	0			-	-
0		1			\$ -	-	0			-	-
MATERIAL and/or TRUCKING											
Description		No. Units			Unit Cost	Amount					
Material	San Lorenzo Builders- 61-0242329	1.00 LS			\$83.37	\$83.37	INCLUDED				\$ 2,668.76
		1.00 LS				\$0.00	INCLUDED				\$ -
		1.00 LS				\$0.00	INCLUDED				\$ -
		1.00 LS				\$0.00	INCLUDED				\$ -
		1.00 LS				\$0.00	INCLUDED				\$ -
WORK DONE BY SUBCONTRACTOR and/or SPECIALISTS											
Description		No. Units			Unit Cost	Amount					
		1.00 LS				\$0.00					\$ 2,668.76
		1.00 LS				\$0.00					\$ 252.93
		1.00 LS				\$0.00					\$ -
TOTAL COST OF EQUIPMENT, MATERIALS AND TRUCKING											
TOTAL COST OF SUBCONTRACTOR AND SPECIALISTS											
13% MARK-UP ON LABOR COST											
10% MARK-UP ON EQUIPMENT, MATERIALS AND TRUCKING COST											
7% MARK-UP ON SUBCONTRACTOR AND SPECIALISTS COST											
TOTAL THIS REPORT											\$ 3,293.92

4910



BIDDING INFORMATION:

NAME: _____
ADDRESS: _____
CITY/STATE/ZIP: _____
PHONE: _____

DAILY EXTRA WORK REPORT

DATE PERFORMED 1-19-23

WORK PERFORMED AT THE DIRECTION OF: SLVWD

DESCRIPTION OF WORK: Erosion Control install (Cross Country)

CONTRACTOR JOB NO. 2202
CONTRACTOR REPORT NO. 2202-

EQUIP NO.	EQUIPMENT	HOURS	HOURLY/DAILY RATE	EXTENDED AMOUNTS	P.A. NO.	LABOR	HOURS	HOURLY RATE	EXTENDED AMOUNTS	MATERIAL AND/OR WORK DONE BY SPECIALISTS	
										NO. UNIT	UNIT COST
1026	Tool Tract	4									
					F	Arden Probst	REG. 4				
					L1	Jose Gomez	REG. 4				
					L1	Anastasio Flores	REG. 4				
					L1	Tom Thurman	REG. 4				
					L1	Jesus Ramos	REG. 4				
					L1	Guerrero Zavala	REG. 4				
					L1	Daniel Ramos	REG. 4				
					L1	Francisco Avila	REG. 4				
					L1	Tim Echison	REG. 4				
										PAYROLL BURDEN AND/OR MARKUPS	
										TOTAL COST OF LABOR	
										TOTAL A & B	
										MARKUP ON EQUIPMENT, MATERIAL AND WORK COST _____ %	
										TOTAL THIS REPORT	
										A	
										B	

ACCEPTED: _____
CONTRACTOR'S REPRESENTATIVE

OWNER/AGENT

INVOICE

2102



235 River St
Santa Cruz, CA 95060
Credit Contact: 831-420-2640
Order Contact: 831-335-4423

DELIVER	CUSTOMER NUMBER	JOB NUMBER	DOCUMENT NUMBER	DOCUMENT DATE
N	551913		61-0242329	01/19/24
DUE DATE	SALES CODE	SALES REP	DELIVERY DATE	REFERENCE NUMBER
02/10/24	104	36	01/19/24	2202
PLEASE REMIT TO:				
Builders FirstSource dba San Lorenzo Lumber PO Box 843909 Los Angeles CA 90084-3909				

FELTON
Sold To:

Store: 61

DANIEL

Job:

ANDERSON PACIFIC ENG CONST INC
1370 NORMAN AVE
SANTA CLARA CA 95054-2056

General Account

PIECES	DESCRIPTION	SKU #	LINEAR FEET	BOARD SQ. FTG.	PRICE	U/M	EXTENDED AMOUNT				
1	20X50 6MIL CLR VISQUEEN	411218			84.99	EA	10% 76.49				
<p>RECEIVED FEB 05 2024 APEC</p>											
<p><i>Thank you for your business!</i> Payment must be received by the <u>10th</u>.</p>											
TOTAL BOARD FT.		TOTAL SQUARE FT.		SUB-TOTAL		CARTAGE		TAX AMOUNT		INVOICE TOTAL	
0		0		76.49		0.00		6.88		83.37	

Customer Purchase Orders will be accepted for tracking purposes only, no additional obligation will be taken by San Lorenzo Lumber. San Lorenzo Lumber's credit terms and terms of sale prevail. ALL INVOICES FOR PURCHASE MADE ON OR BEFORE THE STATEMENT DATE ARE DUE AND PAYABLE ON THE 10TH DAY FOLLOWING THE STATEMENT DATE. A DELINQUENCY CHARGE OF 1-1/2% PER MONTH WILL BE IMPOSED ON BALANCE PAST DUE AS OF THE NEXT CLOSING DATE. CREDITS ALLOWED ON STOCK ITEMS RETURNED SUBJECT TO 15% HANDLING CHARGE. CARTAGE TO YARD, AND CONDITION OF MATERIAL. SPECIAL ORDERS MAY NOT BE RETURNED

8.252450

Description of Work:

Remove trench plates and set up mole directional bore; move directional bore from mainline pipt to new water meter location; install 1" poly line and meter box

EQUIP. NO.	EQUIPMENT	OT/Delay Factor	HOURS		HOURLY RATE	EXTENDED AMOUNTS	LABOR		HOURS	HOURLY RATE	EXTENDED AMOUNTS
			RT	OT							
1018	FORD F150 PICKUP TRUCK	1	8		\$ 37.61	\$ 300.88	FOREMAN		8	\$ 105.82	\$ 846.56
							J. Swain				
1026	FORD F250 CREW TRUCK - UTILITY	1	8		\$ 42.39	\$ 339.12	OPERATOR 3		8	\$ 99.79	\$ 798.32
							F. Flores				
1020	FORD F250 CREW TRUCK - UTILITY	1	8		\$ 42.39	\$ 339.12	CONSTRUCTION SPECIALIST		8	\$ 71.93	\$ 575.44
							J. Gomez				
3022	KOBELCO SK 45SRX-6E	1	8		\$ 48.03	\$ 384.24	LAB APP 3		8	\$ 63.32	\$ 506.56
							D. Lizaola Ramos				
571	SULLAIR 185 48HP COMPRESSOR	1	8		\$ 28.53	\$ 228.24	LABORER 1		8	\$ 71.15	\$ 569.20
							A. Ferreira				
0		1	RT				LABORER 1				
							G. Zavala				
0		1	RT								
0		1	RT								
0		1	RT								
0		1	RT								
0		1	RT								
MATERIAL and/or TRUCKING											
Description	No. Units		Unit Cost		Amount						
Material	Hose Shop- 456753	1.00	LS	\$31.49	\$31.49		INCLUDED				\$ 2,789.52
Material	Sacaborough Lumber- 419154/2	1.00	LS	\$19.60	\$19.60		INCLUDED				\$
		1.00	LS		\$0.00						
		1.00	LS		\$0.00						
		1.00	LS		\$0.00						
WORK DONE BY SUBCONTRACTOR and/or SPECIALISTS											
Description	No. Units		Unit Cost		Amount						
		1.00	LS		\$0.00						
		1.00	LS		\$0.00						
		1.00	LS		\$0.00						
TOTAL COST OF EQUIPMENT, MATERIALS AND TRUCKING											
TOTAL COST OF SUBCONTRACTOR AND SPECIALISTS											
											\$ 2,789.52
											\$ 1,642.69
											\$ -
											\$ 362.64
											\$ 164.27
											\$ -
TOTAL THIS REPORT											\$ 4,959.12

13% MARK-UP ON LABOR COST
10% MARK-UP ON EQUIPMENT, MATERIALS AND TRUCKING COST
7% MARK-UP ON SUBCONTRACTOR AND SPECIALISTS COST

9909

Agenda: 4.4.24
Item: 10c



Sales Invoice

Invoice #: 456753

Invoice Date: 1/23/2024

Packing Slip #: 251893

Shipped from 01

Entered By: CTR2

121 INGALLS STREET, SANTA CRUZ, CA 95060

Phone: 831.425.4673

Fax: 831.425.1280

Acct #: 15160

Bill To: ANDERSON PACIFIC ENGINEER
1370 NORMAN AVENUE
SANTA CLARA, CA 95054--204
USA

Ship To: ANDERSON PACIFIC ENGINEER
1370 NORMAN AVENUE
SANTA CLARA, CA 95054--204
USA

Fax No: 4089709975

Contact: ANTHONY FERREIRA

Order Date	Terms of Sale	Purchase Order	Shipment Method	Tracking #
1/23/2024	N30 - NET 30 DAYS	#2202 ALTA VIA PIPELINE	WILL CALL WILL CALL	

Line	Qty	Item Number	Description	Invoiced	UOM	Unit Price	UOM	Item Total
1	1.00	HOSEKIT	HOSE ASY.	1.00	EA	\$28.8200	EA	\$28.82
----- Consisting Of -----								
	Item Number	Item Description	Required	UM	Commit	B/O	Built	
S	UCHS75	3/4" SHANK CLAW COUPLER	1.00	EA	0.00	0.00	1.00	
S	JS204	1-1/4X1/2" SS CLAMP	2.00	EA	0.00	0.00	2.00	
V	INSTALLATIONS	INSTALL FITTINGS/COUPLINGS ON CUSTOMER HOSE(S) ***NO WARRANTY***	1.00	EA	0.00	0.00	1.00	
SubTotal								\$28.82
Freight (includes Shipping & Handling)								\$0.00
Surcharges								\$0.00
Tax								\$2.67
Total								\$31.49

SCARBOROUGH HOME CENTER, INC.
9470 HIGHWAY 9, BEN LOMOND 95005
MAIL: P.O. BOX 66599
SCOTT VALLEY, CA 95067
PHONE: (831) 336-5142

30 DAYS** + RECEIPT REQUIRED ON
 ALL RETURNS / EXCHANGES

153

Customer No. 12617	Job No.	Purchase Order No. 2202	Reference BROOKDALE	Terms 1% 10TH, NET 11TH,	Clerk JEM	Date 1/19/24	Time 8:11
-----------------------	---------	----------------------------	------------------------	-----------------------------	--------------	-----------------	--------------

Sold To
 * ANDERSON PACIFIC ENGINEERING
 1370 NORMAN AVE.
 SANTA CLARA, CA 95054
 (408) 970-9900

Ship To

DOC# 419154/2

 * INVOICE *

 SLSPR: 00 DEFAULT
 TAX : 200 SALES TAX: S CRUZ COU

SHIPPED	ORDERED	UM	SKU	DESCRIPTION	UNITS	PRICE/PER	EXTENSION
2		EA	4537130	VALVE ACCESS BX7"W/COVER <i>gpo</i>	2	9.99 /EA	19.98

02	** AMOUNT CHARGED TO STORE ACCOUNT **	19.60	TAXABLE	19.98
	(GOMEZ, JOSE)		NON-TAXABLE	0.00
			SUBTOTAL	19.98
			TD DISCOUNT	-2.00
			TAX AMOUNT	1.62
			TOTAL AMOUNT	19.60

Josi Gomez

X
 Received By

Description of Work: Hand trench downhill, install 1" poly line; complete new water line meter connection, backfill @ 11550 Alta Via

EQUIP. NO.	EQUIPMENT	OT/Delay Factor	HOURS		HOURLY RATE	EXTENDED AMOUNTS	LABOR	HOURS		HOURLY RATE	EXTENDED AMOUNTS
			RT	OT				RT	OT		
1018	FORD F150 PICKUP TRUCK	1	8		\$ 37.61	\$ 300.88	FOREMAN	8		\$ 105.82	\$ 846.56
							J. Swain				
1026	FORD F250 CREW TRUCK - UTILITY	1			\$ 42.39		OPERATOR 3			\$ 99.79	
							F. Flores				
1020	FORD F250 CREW TRUCK - UTILITY	1	8		\$ 42.39	\$ 339.12	CONSTRUCTION SPECIAL	8		\$ 71.93	\$ 575.44
							J. Gomez				
3022	KOBELCO SK 45SRX-6E	1			\$ 48.03		LAB APP 3	8		\$ 63.32	\$ 506.56
							D. Lizaola Ramos				
571	SULLAIR 185 49HP COMPRESSOR	1			\$ 28.53		LABORER 1			\$ 71.15	
							A. Ferreira				
0		1					LABORER 1			\$ 71.15	
							G. Zavala				
0		1					0				
0		1					0				
0		1					0				
0		1					0				
0		1					0				
0		1					0				
0		1					0				
MATERIAL and/or TRUCKING											
Description		No. Units			Unit Cost	Amount					
Material	Ferguson- 1838513	1.00	LS		\$260.81	\$260.81	Sub-Total Labor RT		INCLUDED		\$ 1,928.56
Material	Ferguson- 1838507	1.00	LS		\$513.69	\$513.69	Labor Surcharge RT				
		1.00	LS		\$0.00	\$0.00	Sub-Total Labor OT		INCLUDED		\$
		1.00	LS		\$0.00	\$0.00	Labor Surcharge OT				
		1.00	LS		\$0.00	\$0.00	Subsistence				
WORK DONE BY SUBCONTRACTOR and/or SPECIALISTS											
Description		No. Units			Unit Cost	Amount					
		1.00	LS		\$0.00	\$0.00					
		1.00	LS		\$0.00	\$0.00					
		1.00	LS		\$0.00	\$0.00					
TOTAL COST OF LABOR											
											\$ 1,928.56
											\$ 1,414.50
											\$
											\$ 250.71
											\$ 141.45
											\$
											\$ 3,735.22
TOTAL COST OF EQUIPMENT, MATERIALS AND TRUCKING											
TOTAL COST OF SUBCONTRACTOR AND SPECIALISTS											
13% MARK-UP ON LABOR COST											
10% MARK-UP ON EQUIPMENT, MATERIALS AND TRUCKING COST											
7% MARK-UP ON SUBCONTRACTOR AND SPECIALISTS COST											
TOTAL THIS REPORT											

RWT

FERGUSON
WATERWORKS
66 TARP CIRCLE
SALINAS, CA 93901-3717

INVOICE NUMBER	TOTAL DUE	CUSTOMER	PAGE
1838513	\$260.81	454161	1 of 1

PLEASE REFER TO INVOICE NUMBER WHEN MAKING PAYMENT AND REMIT TO:

FERGUSON WATERWORKS #1423
PO BOX 740827
LOS ANGELES, CA 90074-0827

MASTER ACCOUNT NUMBER: 165276

SHIP TO:

COUNTER PICK UP
66 TARP CIRCLE
SALINAS, CA 93901-3717

RECEIVED
JAN 25 2024
APEC

Please contact with Questions: 916-381-6100

ANDERSON PACIFIC ENG CONST INC
1390 NORMAN AVENUE
ALTA VIA PIPELINE REPALCE
SANTA CLARA, CA 95054

SHIP WHSE.	SELL WHSE.	TAX CODE	CUSTOMER ORDER NUMBER	SALESMAN	JOB NAME	INVOICE DATE	BATCH IO	
3306	3306	CA27SL	2202	KXC	ALTA VIA PIPELINE REPALCE	01/24/24	91899	
ORDERED	SHIPPED	ITEM NUMBER	DESCRIPTION		UNIT PRICE	UM	AMOUNT	
500	500	TW10SLDTHHNBL500	10GA SLD COP THHN WIRE BLUE 500		477.460	M	238.73	
INVOICE SUB-TOTAL								238.73
TAX							Monterey/Salinas	22.06
<p>LEAD LAW WARNING: IT IS ILLEGAL TO INSTALL PRODUCTS THAT ARE NOT "LEAD FREE" IN ACCORDANCE WITH US FEDERAL OR OTHER APPLICABLE LAW IN POTABLE WATER SYSTEMS ANTICIPATED FOR HUMAN CONSUMPTION. PRODUCTS WITH "NP" IN THE DESCRIPTION ARE NOT LEAD FREE AND CAN ONLY BE INSTALLED IN NON-POTABLE APPLICATIONS. BUYER IS SOLELY RESPONSIBLE FOR PRODUCT SELECTION.</p> <p>WATER FLOW RATE NOTICE: LAVATORY FAUCETS WITH FLOW RATES OVER 0.5 GPM ARE NOT ALLOWED FOR "PUBLIC USE" IN CALIFORNIA.</p>								

Looking for a more convenient way to pay your bill?

Log in to [Ferguson.com](https://www.ferguson.com) and request access to Online Bill Pay.



TERMS: NET 10TH PROX	ORIGINAL INVOICE	TOTAL DUE	\$260.81
----------------------	------------------	-----------	----------

All past due amounts are subject to a service charge of 1.5% per month, or the maximum allowed by law, if lower. If Buyer fails to pay within terms, then in addition to other remedies, Buyer agrees to pay Seller all costs of collection, including reasonable attorney fees. Complete terms and conditions are available upon request or at <https://www.ferguson.com/content/website-info/terms-of-sale>, incorporated by reference. Seller may convert checks to ACH.



FERGUSON WATERWORKS #3306
66 TARP CIRCLE
SALINAS, CA 93901-3717

157

ORDER NO. 1928513
REQUIRED DATE 01/24/24
SHIP WHS. 3306
SELL WHS. 3306

STOCK SALES ORDER

ACCEPT B/O = N
SHOWROOM = N
SOURCE = SOE
IB FRT = N 0.00
OP SHP = N 0.00
24 JAN 2024 12:52:54

WRITER SALESMAN
SD KXC/JPL
TAG PO. NO.

CUSTOMER NO. 454161
CUSTOMER ALPHA ANDERSONP
CONTRACT NO.

ANDERSON PACIFIC ENG CONST INC
1390 NORMAN AVENUE
ALTA VIA PIPELINE REPALCE
SANTA CLARA, CA 95054

COUNTER PICK UP
66 TARP CIRCLE
SALINAS, CA 93901-3717

CUST PH: 408-970-9900

CUSTOMER PO. NO. 2202
JOB NAME ALTA VIA PIPELINE REPALCE

ATTN:

SHIP VIA CPU COUNTER PICK-UP

INSTRUCTIONS

OML CONTACT Steven Drew

VENDOR

VENDOR PO. NO.

ROUTE NO.

RUN NO.

DEPART TIME

ROUTE DESC.

PACKED BY

CHECKED BY

P.O. NO.

aisle loc 016-E3-02

LINE	ORDER QTY.	SHIP QTY.	RO QTY.	ITEM CODE	DESCRIPTION	U/M	UNIT PRICE	TOTAL	
1	500	500	0	01W105LPTHRWLS00	10GA SLD COP THIN WIRE BLUE 500				
<p>***** END LAW WARNING: IT IS ILLEGAL TO INSTALL PRODUCTS THAT ARE NOT "LEAD FREE" IN ACCORDANCE WITH US FEDERAL OR OTHER APPLICABLE LAW IN POTABLE WATER SYSTEMS ANTICIPATED FOR HUMAN CONSUMPTION. PRODUCTS WITH "MP 10" ON DESCRIPTION ARE NOT LEAD FREE AND CAN ONLY BE INSTALLED IN NON-POTABLE APPLICATIONS. BUYER IS SOLELY RESPONSIBLE FOR PRODUCT SELECTION. WATER FLOW RATE NOTICE: Lavatory faucets with flow rates over 0.5 GPM are not allowed for public use in California. *****</p>									
							TAX	LESS DEPOSIT	TOTAL DUE

CUSTOMER'S SIGNATURE: *Sose Gomez*
DATE: _____

TERMS: CUSTOMER COPY

Agenda: 4.4.24
Item: 10c

Agenda: 4.4.24
Item: 10c
202

FERGUSON
WATERWORKS
66 TARP CIRCLE
SALINAS, CA 93901-3717

INVOICE NUMBER	TOTAL DUE	CUSTOMER	PAGE
1838507	\$513.69	454161	1 of 1

PLEASE REFER TO INVOICE NUMBER WHEN MAKING PAYMENT AND REMIT TO:

FERGUSON WATERWORKS #1423
PO BOX 740827
LOS ANGELES, CA 90074-0827

MASTER ACCOUNT NUMBER: 185276

SHIP TO:

COUNTER PICK UP
66 TARP CIRCLE
SALINAS, CA 93901-3717

Please contact with Questions: 916-381-6100

RECEIVED
JAN 25 2024
APEC

ANDERSON PACIFIC ENG CONST INC
1390 NORMAN AVENUE
ALTA VIA PIPELINE REPALCE
SANTA CLARA, CA 95054

SHIP WHSE.	SELL WHSE.	TAX CODE	CUSTOMER ORDER NUMBER	SALESMAN	JOB NAME	INVOICE DATE	BATCH
3306	3306	CA27SL	2202	KXC	ALTA VIA PIPELINE REPALCE	01/24/24	IO 91889
ORDERED	SHIPPED	ITEM NUMBER	DESCRIPTION		UNIT PRICE	UM	AMOUNT
600 10	600 10	AX41250300B FINSERT52	1X300 CTS 250 PSI NSF BLK 1 CTS PET / HDPE DRG INS STFNR		0.753 1.840	FT EA	451.80 18.40
					INVOICE SUB-TOTAL		470.20
					TAX		43.49
					Monterey/Salinas		
					NOTICE		
					<> WARNING: Cancer and Reproductive Harm. www.P65Warnings.ca.gov		
<p>LEAD LAW WARNING: IT IS ILLEGAL TO INSTALL PRODUCTS THAT ARE NOT "LEAD FREE" IN ACCORDANCE WITH US FEDERAL OR OTHER APPLICABLE LAW IN POTABLE WATER SYSTEMS ANTICIPATED FOR HUMAN CONSUMPTION. PRODUCTS WITH "NP" IN THE DESCRIPTION ARE NOT LEAD FREE AND CAN ONLY BE INSTALLED IN NON-POTABLE APPLICATIONS. BUYER IS SOLELY RESPONSIBLE FOR PRODUCT SELECTION.</p> <p>WATER FLOW RATE NOTICE: LAVATORY FAUCETS WITH FLOW RATES OVER 0.5 GPM ARE NOT ALLOWED FOR 'PUBLIC USE' IN CALIFORNIA.</p>							

Looking for a more convenient way to pay your bill?
Log in to **Ferguson.com** and request access to Online Bill Pay.



TERMS: NET 10TH PROX	ORIGINAL INVOICE	TOTAL DUE	\$513.69
----------------------	------------------	-----------	----------

All past due amounts are subject to a service charge of 1.5% per month, or the maximum allowed by law, if lower. If Buyer fails to pay within terms, then in addition to other remedies, Buyer agrees to pay Seller all costs of collection, including reasonable attorney fees. Complete terms and conditions are available upon request or at <https://www.ferguson.com/content/website-info/terms-of-sale>, incorporated by reference. Seller may convert checks to ACH.

ERGUSON WATERWORKS

ERGUSON WATERWORKS #3306
 66 TARP CIRCLE
 SALINAS, CA 93901-3717

159

PHONE: 831-424-3330 FAX: 831-421-3384
 REQUIRED DATE: 01/24/24 SHIP WHS: 3306
 ORDER NO. 1938507 CUSTOMER ALPHA: ANDERSONP CONTRACT NO.

CUSTOMER NO. 454161
 ANDERSON PACIFIC ENG CONST INC
 1390 NORMAN AVENUE
 ALTA VIA PIPELINE REPALCE
 SANTA CLARA, CA 95054

CUSTOMER P.O. NO. 2202
 JOB NAME: ALTA VIA PIPELINE REPALCE

INSTRUCTIONS: STOCK SALE ORDER 9909
 ORDER DATE: 01/24/24
 ORDERED BY: 305E
 SHIP TO: 66 TARP CIRCLE, SALINAS, CA 93901-3717

ATTN: 9909

SHOWROOM = N
 SOURCE = SOE
 IB FRI = N
 OF SHP = N
 24 JAN 2024 12:44:47
 SALESMAN: KXC/JPL
 WRITER: SDJ
 TAG PO. NO.
 OML CONTACT: Steven Drew
 VENDOR
 VENDOR PO. NO.
 RUN NO. DEPART T
 ROUTE NO.
 ROUTE DESC.
 CHECKED BY
 AISLE LOC

9909

Agenda: 4.4.24
 Item: 10c

LINE	ORDER QTY	SHIP QTY	ITEM CODE	DESCRIPTION	U/M	DELIVERED BY				TOTAL	PO. NO.	AISLE LOC
						PCS	BAGS	BOXES	CRATES			
1	800	800	0441203003	ALTA VIA PIPELINE REPALCE								
2	10	10	0441203002	ALTA VIA PIPELINE REPALCE								
3				DESCRIPTION								
4				I CIS PET / HOPE DRY INS SIFTK								
5				NOTICE								
6				ALTA VIA PIPELINE REPALCE								
7				ALTA VIA PIPELINE REPALCE								
8				ALTA VIA PIPELINE REPALCE								
9				ALTA VIA PIPELINE REPALCE								
10				ALTA VIA PIPELINE REPALCE								
11				ALTA VIA PIPELINE REPALCE								
12				ALTA VIA PIPELINE REPALCE								
13				ALTA VIA PIPELINE REPALCE								
14				ALTA VIA PIPELINE REPALCE								
15				ALTA VIA PIPELINE REPALCE								
16				ALTA VIA PIPELINE REPALCE								
17				ALTA VIA PIPELINE REPALCE								
18				ALTA VIA PIPELINE REPALCE								
19				ALTA VIA PIPELINE REPALCE								
20				ALTA VIA PIPELINE REPALCE								
21				ALTA VIA PIPELINE REPALCE								
22				ALTA VIA PIPELINE REPALCE								
23				ALTA VIA PIPELINE REPALCE								
24				ALTA VIA PIPELINE REPALCE								
25				ALTA VIA PIPELINE REPALCE								
26				ALTA VIA PIPELINE REPALCE								
27				ALTA VIA PIPELINE REPALCE								
28				ALTA VIA PIPELINE REPALCE								
29				ALTA VIA PIPELINE REPALCE								
30				ALTA VIA PIPELINE REPALCE								
31				ALTA VIA PIPELINE REPALCE								
32				ALTA VIA PIPELINE REPALCE								
33				ALTA VIA PIPELINE REPALCE								
34				ALTA VIA PIPELINE REPALCE								
35				ALTA VIA PIPELINE REPALCE								
36				ALTA VIA PIPELINE REPALCE								
37				ALTA VIA PIPELINE REPALCE								
38				ALTA VIA PIPELINE REPALCE								
39				ALTA VIA PIPELINE REPALCE								
40				ALTA VIA PIPELINE REPALCE								
41				ALTA VIA PIPELINE REPALCE								
42				ALTA VIA PIPELINE REPALCE								
43				ALTA VIA PIPELINE REPALCE								
44				ALTA VIA PIPELINE REPALCE								
45				ALTA VIA PIPELINE REPALCE								
46				ALTA VIA PIPELINE REPALCE								
47				ALTA VIA PIPELINE REPALCE								
48				ALTA VIA PIPELINE REPALCE								
49				ALTA VIA PIPELINE REPALCE								
50				ALTA VIA PIPELINE REPALCE								
51				ALTA VIA PIPELINE REPALCE								
52				ALTA VIA PIPELINE REPALCE								
53				ALTA VIA PIPELINE REPALCE								
54				ALTA VIA PIPELINE REPALCE								
55				ALTA VIA PIPELINE REPALCE								
56				ALTA VIA PIPELINE REPALCE								
57				ALTA VIA PIPELINE REPALCE								
58				ALTA VIA PIPELINE REPALCE								
59				ALTA VIA PIPELINE REPALCE								
60				ALTA VIA PIPELINE REPALCE								
61				ALTA VIA PIPELINE REPALCE								
62				ALTA VIA PIPELINE REPALCE								
63				ALTA VIA PIPELINE REPALCE								
64				ALTA VIA PIPELINE REPALCE								
65				ALTA VIA PIPELINE REPALCE								
66				ALTA VIA PIPELINE REPALCE								
67				ALTA VIA PIPELINE REPALCE								
68				ALTA VIA PIPELINE REPALCE								
69				ALTA VIA PIPELINE REPALCE								
70				ALTA VIA PIPELINE REPALCE								
71				ALTA VIA PIPELINE REPALCE								
72				ALTA VIA PIPELINE REPALCE								
73				ALTA VIA PIPELINE REPALCE								
74				ALTA VIA PIPELINE REPALCE								
75				ALTA VIA PIPELINE REPALCE								
76				ALTA VIA PIPELINE REPALCE								
77				ALTA VIA PIPELINE REPALCE								
78				ALTA VIA PIPELINE REPALCE								
79				ALTA VIA PIPELINE REPALCE								
80				ALTA VIA PIPELINE REPALCE								
81				ALTA VIA PIPELINE REPALCE								
82				ALTA VIA PIPELINE REPALCE								
83				ALTA VIA PIPELINE REPALCE								
84				ALTA VIA PIPELINE REPALCE								
85				ALTA VIA PIPELINE REPALCE								
86				ALTA VIA PIPELINE REPALCE								
87				ALTA VIA PIPELINE REPALCE								
88				ALTA VIA PIPELINE REPALCE								
89				ALTA VIA PIPELINE REPALCE								
90				ALTA VIA PIPELINE REPALCE								
91				ALTA VIA PIPELINE REPALCE								
92				ALTA VIA PIPELINE REPALCE								
93				ALTA VIA PIPELINE REPALCE								
94				ALTA VIA PIPELINE REPALCE								
95				ALTA VIA PIPELINE REPALCE								
96				ALTA VIA PIPELINE REPALCE								
97				ALTA VIA PIPELINE REPALCE								
98				ALTA VIA PIPELINE REPALCE								
99				ALTA VIA PIPELINE REPALCE								
100				ALTA VIA PIPELINE REPALCE								

NO RETURNS ALLOWED WITHOUT PROPER AUTHORIZATION. RETURNED MATERIALS SUBJECT TO HANDLING CHARGES. SEE REVERSE SIDE FOR IMPORTANT TERMS AND CONDITIONS OF SALE AND LIMITATIONS OF WARRANTY.

CUSTOMERS

DATE: _____
 CUSTOMERS: _____

TERMS:

INBOUNDED FREIGHT	OUTBOUND SHIPPING	TAX	LESS DEPOSIT	TOTAL DUE

A16 DT0237 (09/16)

Hand trench/ clear and grub downhill from new meter to residence; install 1"poly line

Description of Work:

EQUIP. NO.	EQUIPMENT	OT/Delay Factor	HOURS		HOURLY RATE	EXTENDED AMOUNTS	LABOR	HOURS		HOURLY RATE	EXTENDED AMOUNTS
			RT	OT				RT	OT		
1018	FORD F150 PICKUP TRUCK	1	8		\$ 37.61	\$ 300.88	FOREMAN	8		\$ 105.82	\$ 846.56
							J. Swain				
1026	FORD F250 CREW TRUCK - UTILITY	1			\$ 42.39	\$ -	LABORER 1	8		\$ 71.15	\$ 569.20
							A. Flores				
1020	FORD F250 CREW TRUCK - UTILITY	1			\$ 42.39	\$ -	CONSTRUCTION SPECIA	2		\$ 71.93	\$ 143.86
							J. Gomez				
3022	KOBELCO SK 45SRX-6E	1			\$ 48.03	\$ -	LAB APP 3	8		\$ 63.32	\$ 506.56
							D. Lizaola Ramos				
571	SULLAIR 185 49HP COMPRESSOR	1			\$ 28.53	\$ -	LABORER 1	8		\$ 71.15	\$ 569.20
							F. Flores				
0		1			\$ -	\$ -	LABORER 1	8		\$ 71.15	\$ 569.20
							T. Etchison				
0		1			\$ -	\$ -	LABORER 1	8		\$ 71.15	\$ 569.20
							C. Guidotti				
0		1			\$ -	\$ -	0			\$ -	\$ -
							0			\$ -	\$ -
0		1			\$ -	\$ -	0			\$ -	\$ -
							0			\$ -	\$ -
0		1			\$ -	\$ -	0			\$ -	\$ -
							0			\$ -	\$ -
MATERIAL and/or TRUCKING											
Description		No. Units			Unit Cost	Amount					
Material	San Lorenzo Lumber - 63-0758200	1.00 LS			\$224.45	\$224.45	INCLUDED				\$ 3,773.78
Material	Granite- 31634652	1.00 LS			\$253.75	\$253.75					\$ -
Material	Scarborough Lumber- 419451/2	1.00 LS			\$125.28	\$125.28	INCLUDED				\$ -
		1.00 LS			\$0.00	\$0.00					\$ -
		1.00 LS			\$0.00	\$0.00					\$ -
WORK DONE BY SUBCONTRACTOR and/or SPECIALISTS											
Description		No. Units			Unit Cost	Amount					
		1.00 LS			\$0.00	\$0.00					\$ -
		1.00 LS			\$0.00	\$0.00					\$ -
		1.00 LS			\$0.00	\$0.00					\$ -
TOTAL COST OF LABOR											
											\$ 3,773.78
											\$ 904.36
											\$ -
											\$ 490.59
											\$ 90.44
											\$ -
											\$ 5,259.17
TOTAL COST OF EQUIPMENT, MATERIALS AND TRUCKING											
TOTAL COST OF SUBCONTRACTOR AND SPECIALISTS											
13% MARK-UP ON LABOR COST											
10% MARK-UP ON EQUIPMENT, MATERIALS AND TRUCKING COST											
7% MARK-UP ON SUBCONTRACTOR AND SPECIALISTS COST											
TOTAL THIS REPORT											

9909

ANDERSON PACIFIC
Engineering Construction, Inc.

BILLING INFORMATION:
16 NAME: ANDERSON PACIFIC
ADDRESS: 1370 NORMAN AVE
CITY/STATE/ZIP: SANTA CLARA, CA
PHONE: 408.970.9900

DAILY EXTRA WORK REPORT

DATE PERFORMED 1/26/2024

WORK PERFORMED AT THE DIRECTION OF: SAN LORENZO WATER DISTRICT CONTRACTOR JOB NO. 2202
DESCRIPTION OF WORK: HAND TRENCH/CLEAR & GRAVE DOWNHILL FROM NEW WATER METER TO RESURGENCE - INSTALL 1" Poly CONTRACTOR REPORT NO.

EQUIP NO.	EQUIPMENT	HOURS	HOURLY/DAILY RATE	EXTENDED AMOUNTS	P.R. NO.	LABOR	HOURS	HOURLY RATE	EXTENDED AMOUNTS
1009	FORD F-550	8			L1	CHANCE GUIDOFFI	REG. 8 O.T.		
					L1	TIM ERHISON	REG. 8 O.T.		
					L1	FRANCISCO FLORES	REG. 8 O.T.		
					L3	DAVID RAMOS	REG. 8 O.T.		
					F	JOE SWAIN	REG. 8 O.T.		
					L1	ANNA FLORES	REG. 2 O.T.		
					CS	JOSG GOMEZ	REG. O.T.		

MATERIAL AND/OR WORK DONE BY SPECIALISTS			NO. UNIT	UNIT COST	EXTENDED	SUB-TOTAL		
SAN LORENZO	63-0758200					PAYROLL BURDEN AND/OR MARKUPS		
CEMENT - C&G MIX	3639452					TOTAL COST OF LABOR		
SCARABAWITH LUMBER	4194512					A		
TOTAL COST OF EQUIPMENT, MATERIALS AND WORK						B		

ACCEPTED: _____ CONTRACTOR'S REPRESENTATIVE
TOTAL A & B _____
MARKUP ON EQUIPMENT, MATERIAL AND WORK COST _____ %
TOTAL THIS REPORT _____

OWNER/AGENT

235 RIVER ST
SANTA CRUZ CA 95060-2720 (831) 426-1020

ANDERSON PACIFIC ENG CONST INC
1370 MORTMAN AVE
SANTA CLARA CA 95054-0000

PHONE #: 408-970-9900

162

DOCUMENT TYPE
CHARGE SALE

J
O
B

General Account
ALTA VIA
WATER MAIN



PC 581913
CUSTOMER NUMBER 63-0758200
JOB NUMBER 63-0758200
DOCUMENT NUMBER 1/25/24
DOCUMENT DATE 1/25/24

ORDERED BY JOSE
CUSTOMER REFERENCE # 2202

DL NUMBER 000000
CC NUMBER H
DELIVER DATE 1/25/24
DELIVERY DATE 25
SALES CODE 39
SALES REF

QTY	DESCRIPTION	MPG. #	SKU	UPC	LINEAL FEET	BOARD SQUARE	PRICE	D/M	EXTENDED AMOUNT	
1	PRO DOPE THREAD SEALANT 8OZ.	481065	541101	032628-154209			7.79	EA 10%	7.01	
2	BLACK NIPPLE 3/4 X 2"	435020	590612	054374-018376			1.79	EA 10%	3.22	
4	GALV 3/4" SHORT NIPPLE	445015	590747	054374-043521			1.79	EA 10%	6.44	
3	GALV 45 DEG EL 1"	440026	590952	054374-022700			4.99	EA 10%	13.47	
1	TRIE TEMP OHDL 16" DRAIN SPADE	2540700	102436	049206-665136			47.99	EA 10%	43.19	
1	LH ROUND POINT SHOVEL	154300	100281	049206-155435			16.99	EA 10%	16.99	
4	SHOVEL LH ROUND POINT FIBERGLSS	LH002	102874	034613-000027			19.99	EA 10%	71.96	
3	18" MACHETE W/SHEATH	JLD-006-H3L	17611	045734-987425			15.99	EA 10%	43.17	
Customer Purchase Orders will be accepted for tracking purposes only, no additional obligation will be taken by Builders FirstSource. BFS's credit terms and terms of sale prevail.										
CHECKED BY					TOTAL BOARD FEET	TOTAL SQ. FEET	SUB-TOTAL	CARTAGE	TAX AMOUNT	DOCUMENT TOTAL
							205.45	.00	19.00	224.45

THE UNDERSIGNED AGREES TO THE ADDITIONAL TERMS AND CONDITIONS ON THE REVERSE SIDE.
BY Jose Jones

CUSTOMER AGREES THAT THIS ORDER LISTED ABOVE IS CORRECT IN EVERY DETAIL. IF THIS ORDER IS CANCELLED OR IF CUSTOMER FAILS TO PICK UP MATERIAL WITHIN 14 DAYS AFTER NOTIFICATION, CUSTOMER AGREES TO PAY ALL HANDLING CHARGES FOR MATERIALS RETURNED TO SUPPLIER AND FURTHER AGREES TO PAY ENTIRE PURCHASE PRICE IF MATERIAL CANNOT BE RETURNED.

CUSTOMER SIGNATURE _____
P.O. _____
APPROX DATE REC. _____
DATE NOTIFIED _____
% RETURN CHARGE _____

INVOICE



PLEASE MAIL REMITTANCE TO:
 Granite Construction Company
 PO Box 742478
 Los Angeles, CA 90074-2478

INVOICE DATE: 1/26/2024

Bill To:

ANDERSON PACIFIC ENGINEERING CONSTRUCT
 1370 NORMAN AVENUE
 SANTA CLARA CA 95054-2056
 AP@ANDPAC.COM

ORDER NO.	CUSTOMER NO.	PLANT	INVOICE NO.
282857	120862	FELTON A C PLANT 100321	2647399
ORIGINAL INVOICE #		JOB ADDRESS	DATE OF SALE
		SLVWD ALTA VIA PIPELINE REPLACEMENT ALTA VIA BROOKDALE CA 95007	1/26/2024
			PO #
			2202

A LATE FEE OF 1.5% PER MONTH (18% PER ANNUM) WILL BE APPLIED ON PAST DUE BALANCES

A CREDIT CARD FEE OF 2.3% WILL BE APPLIED TO ALL CREDIT CARD PAYMENTS MADE MORE THAN 10 BUSINESS DAYS AFTER THE INVOICE DATE ABOVE

TICKET NUMBER	TICKET DATE	MATERIAL DESCRIPTION	QTY	UNIT PRICE	EXTENDED AMOUNT	FOB	TAX RATE AREA
31634652	1/26/2024	1705 - 3/8" CMASC250	1.980	TN 110.000	\$217.80	P	V050870000
		TOTAL: 1705 - 3/8" CMASC250	1.980	TN	\$217.80		
		3786 - ENVIRONMENTAL FEE A	1.0000	LD	\$15.00		

RECEIVED
 JAN 31 2024
 APEC

TERMS: A/R Net 30 Days

The prevailing party shall be entitled to reasonable attorney's fees and costs in any action to collect the amounts due hereunder.
 Note: If haul charges are indicated separately above, then the title passage of materials is at the plant, with delivery provided for customers.
 The environmental fee is not a tax, surcharge, or fee mandated by or remitted to any governmental or regulatory agency but used to recover direct and indirect costs for Granite and its subsidiaries operations to be conducted in an environmentally sustainable manner.
 For any question regarding this billing, please call (831)768-4002.

TOTAL FREIGHT	.00
MATERIAL	217.80
FEES	15.00
SALES TAX	20.95

FOB P=PLANT J=JOB Thank You for your business. WARNING: THIS PRODUCT CONTAINS A CHEMICAL KNOWN TO THE STATE OF CALIFORNIA TO CAUSE CANCER, BIRTH DEFECTS OR OTHER REPRODUCTIVE HARM. MSDS SHEETS AVAILABLE AT WWW.GRANITECONSTRUCTION.COM/MSDS OR BY CONTACTING YOUR LOCAL OFFICE.	INVOICE TOTAL \$253.75
--	---

101

SCARBOROUGH HOME CENTER, INC.
9470 HIGHWAY 9, BEN LOMOND 95005
MAIL: P.O. BOX 66599
SCOTT'S VALLEY, CA 95067
PHONE: (831) 336-5142

PAGE NO 1

30 DAYS** + RECEIPT REQUIRED ON
ALL RETURNS / EXCHANGES

Customer No. 12617	Job No. 2202	Purchase Order No. 2202	PO # 2202	Reference	Terms	Clerk	Date	Time
				13 10TH, NET 11TH,		JEM	1/26/24	8:23

Sold To
* ANDERSON PACIFIC ENGINEERING
1370 NORMAN AVE.
SANTA CLARA, CA 95054
(408) 970-9900

Ship To
[Blank Box]

DOC# 419451/2

* INVOICE *

SLSPR: 00 DEFAULT
TAX : 200 SALES TAX: S CRUZ COU

SHIPPED	ORDERED	UM	SKU	DESCRIPTION	UNITS	PRICE/PER	EXTENSION
1	EA	7595499		PICK 36" 5 LB	1	59.99 /EA	59.99 *
1	EA	1025306		Microfiber 12 pack	1	13.99 /EA	13.99 *
1	EA	87133		SIMPLE GREEN 24OZ.	1	5.99 /EA	5.99 *
1	EA	7798903		GLOVES LTHR PALM LG 3PK	1	16.99 /EA	16.99 *
2	EA	6355952		ACE LATEX GLOVE LRG 3PK	2	9.99 /EA	19.98
<p>RECEIVED JAN 26 2024 APEC</p>							
** AMOUNT CHARGED TO STORE ACCOUNT **						125.28	
(PROOST, ANDON)							
						TAXABLE	116.94
						NON-TAXABLE	0.00
						SUBTOTAL	116.94
						TD DISCOUNT	-2.00
						TAX AMOUNT	10.34
						TOTAL AMOUNT	125.28

521

X
Received By

DAILY EXTRA WORK REPORT

Work Performed by: ANDERSON PACIFIC ENGINEERING CONSTRUCTION, INC.
Work Performed at the direction of: San Lorenzo Valley Water District

APEC Job #: 2202
Date Performed: 1/29/2024
DEWR #: PCO-10-12

Description of Work: Cross country trench and install poly line; backfill and complete new water meter connections @ 11540, 11570, 11545 Alta Via

EQUIP. NO.	EQUIPMENT	OT/Delay Factor	HOURS		HOURLY RATE	EXTENDED AMOUNTS	LABOR	HOURS		HOURLY RATE	EXTENDED AMOUNTS
			RT	OT				RT	OT		
1018	FORD F150 PICKUP TRUCK	1	8		\$ 37.61	\$ 300.88	49 FOREMAN J. Swain	8 RT		\$ 105.82	\$ 846.56
1026	FORD F250 CREW TRUCK - UTILITY	1			\$ 42.39	\$ -	LABORER 1 A. Flores	RT OT		\$ 71.15	\$ -
1020	FORD F250 CREW TRUCK - UTILITY	1	8		\$ 42.39	\$ 339.12	CONSTRUCTION SPECIA J. Gomez	8 RT		\$ 71.93	\$ 575.44
3022	KOBELCO SK 45SRX-6E	1			\$ 48.03	\$ -	LAB APP 3 D. Lizaola Ramos	RT OT		\$ 63.32	\$ 506.56
571	SULLAIR 185 49HP COMPRESSOR	1			\$ 28.53	\$ -	LABORER 1 F. Flores	8 RT		\$ 71.15	\$ 569.20
0		1			\$ -	\$ -	LABORER 1 T. Etchison	8 RT		\$ 71.15	\$ 569.20
0		1			\$ -	\$ -	LABORER 1 C. Guidotti	8 RT		\$ 71.15	\$ 569.20
0		1			\$ -	\$ -	LABORER 1 J. Ramos	8 RT		\$ 71.15	\$ 569.20
0		1			\$ -	\$ -	LABORER 1 G. Zavala	8 RT		\$ 71.15	\$ 569.20
0		1			\$ -	\$ -	0	RT OT		\$ -	\$ -
0		1			\$ -	\$ -	0	RT OT		\$ -	\$ -
MATERIAL and/or TRUCKING											
Description		No. Units			Unit Cost	Amount					
		1.00 LS				\$0.00			INCLUDED		\$ 4,774.56
		1.00 LS				\$0.00					
Material	Scarborough Lumber- 419594/2	1.00 LS			\$84.94	\$84.94			INCLUDED		\$ -
		1.00 LS				\$0.00					
		1.00 LS				\$0.00					
WORK DONE BY SUBCONTRACTOR and/or SPECIALISTS											
Description		No. Units			Unit Cost	Amount					
		1.00 LS				\$0.00					
		1.00 LS				\$0.00					
		1.00 LS				\$0.00					
TOTAL COST OF EQUIPMENT, MATERIALS AND TRUCKING											
TOTAL COST OF SUBCONTRACTOR AND SPECIALISTS											
TOTAL THIS REPORT											
											\$ 4,774.56
											\$ 724.94
											\$ -
											\$ 620.69
											\$ 72.49
											\$ -
											\$ 6,192.69

13% MARK-UP ON LABOR COST
10% MARK-UP ON EQUIPMENT, MATERIALS AND TRUCKING COST
7% MARK-UP ON SUBCONTRACTOR AND SPECIALISTS COST



REPORT OF INVESTIGATION
 DATE: August 1, 2024
 PROJECT: 17th WARDMAN DRIVE
 LOCATION: SAVING CLAY, CA
 NUMBER: 408-970-9982

DAILY EXTRA WORK REPORT

DATE: 1-27-2024

WORKER'S NAME: SAN LORENZO WATER DISTRICT

CONTRACTOR JOB NO: 1202
 CONTRACTOR REPORT NO: 1202

PROJECT: CHICO COUNTY TRENCH & PUMP INSTALLATION & BACKFILL

CONTRACT: NEW WATER MAIN CONNECTIONS @ 11540 - 11570 - 11545 ALTA VIA

TEAM NO.	EQUIPMENT	HOURS	HOURLY RATE	EXTENDED AMOUNTS	P.A. NO.	LABOR	HOURS	HOURLY RATE	EXTENDED AMOUNTS	TOTAL COST OF LABOR	
										A	B
1514	FOUR F-70	8			F	JOE SWAN	8				
1520	FOUR WILSON TRENCH	8			ES	JOSIE GOMEZ (NEWS)	8				
					LI	CINDY RAMOS	8				
					LI	CHARLE GARDINI	8				
					LI	TIM RICHMOND	8				
					LI	FRANK FLORES	8				
					A3	DANIEL RAMOS	8				
					LI	GUILHERMO CAVALA	8				
MATERIAL AND/OR WORK DONE BY SPECIALISTS										SUB TOTAL	
SANDWICH 417514/2										PAYROLL BURDEN AND/OR MARKUPS	
TOTAL COST OF EQUIPMENT, MATERIALS AND WORK										TOTAL COST OF LABOR	
										A	
										B	
TOTAL A+B											
MARKUP ON EQUIPMENT, MATERIAL AND WORK COST											
TOTAL THIS REPORT											

2706

SCARBOROUGH HOME CENTER, INC.
9470 HIGHWAY 9, BEN LOMOND 95005
MAIL: P.O. BOX 66599
SCOTT'S VALLEY, CA 95067
PHONE: (831) 336-5142

30 DAYS** + RECEIPT REQUIRED ON
ALL RETURNS / EXCHANGES

Customer No. 12617	Job No. 2202	Purchase Order No. 2202	Reference BROOKDALE WATER MAIN	Terms 13 10TH, NET 11TH,	Check PTM	Date 1/29/24	Time 2:12
-----------------------	-----------------	----------------------------	-----------------------------------	-----------------------------	--------------	-----------------	--------------

Ship To
[Redacted]

Sold To
* ANDERSON PACIFIC ENGINEERING
1370 NORMAN AVE.
SANTA CLARA, CA 95054
(408) 970-9900

DOC# 41959472

* INVOICE *

TERM#567
ST.SPR: 00 DEFAULT
TAX : 200 SALES TAX: S CRUZ COU

SHIPPED	ORDERED	UM	SKU	DESCRIPTION	UNITS	PRICE/PER	EXTENSION
1	EA	47800		RED COUPLNG GLV 1X3/4"	1	5.99 /EA	5.99
1	EA	4124202		NIPPLE GALV 3/4"X3"	1	2.99 /EA	2.99
1	EA	47768		90 DG ELBW GALV 3/4X3/4"	1	3.99 /EA	3.99
1	EA	41713		PIPE GALV TBE 3/4"X36"	1	19.99 /EA	19.99
1	EA	41055		TEE 3/4" GALVANIZED	1	7.99 /EA	7.99 *
1	EA	4124292		NIPPLE GALV 3/4"X6"	1	3.99 /EA	3.99
1	EA	4336780		3/4" BRONZE GLOBE VALVE	1	33.99 /EA	33.99 *
1	EA	4124533		NIPPLE GALV 1"X3.5"	1	2.99 /EA	2.99
RECEIVED JAN 29 2024 APEC							
** AMOUNT CHARGED TO STORE ACCOUNT **					84.94	TAXABLE	81.92
(GOMEZ, JOSE)						NON-TAXABLE	0.00
						SUBTOTAL	81.92
						TD DISCOUNT	-3.99
						TAX AMOUNT	7.01
						TOTAL AMOUNT	84.94

58

Jose Gomez

X

Received By

EQUIP. NO.	EQUIPMENT	OT/Delay Factor	HOURS		HOURLY RATE	EXTENDED AMOUNTS	LABOR	HOURS		HOURLY RATE	EXTENDED AMOUNTS
			RT	OT				RT	OT		
1018	FORD F150 PICKUP TRUCK	1			\$ 37.61	\$ -	49 FOREMAN	RT		\$ 105.82	\$ -
					\$ -	\$ -	J. Swain	OT		\$ -	\$ -
1026	FORD F250 CREW TRUCK - UTILITY	1			\$ 42.39	\$ -	LABORER 1	RT		\$ 71.15	\$ -
					\$ -	\$ -	A. Flores	OT		\$ -	\$ -
1020	FORD F250 CREW TRUCK - UTILITY	1		8	\$ 42.39	\$ 339.12	CONSTRUCTION SPECIALIST	RT	8	\$ 71.93	\$ 575.44
					\$ -	\$ -	J. Gomez	OT		\$ -	\$ -
3022	KOBELCO SK 45SRX-6E	1			\$ 48.03	\$ -	LAB APP 3	RT	8	\$ 63.32	\$ 506.56
					\$ -	\$ -	D. Lizola Ramos	OT		\$ -	\$ -
571	SULLAIR 185 49HP COMPRESSOR	1			\$ 28.53	\$ -	LABORER 1	RT		\$ 71.15	\$ -
					\$ -	\$ -	F. Flores	OT		\$ -	\$ -
0		1			\$ -	\$ -	LABORER 1	RT		\$ 71.15	\$ -
					\$ -	\$ -	T. Etchison	OT		\$ -	\$ -
0		1			\$ -	\$ -	LABORER 1	RT		\$ 71.15	\$ -
					\$ -	\$ -	C. Guidotti	OT		\$ -	\$ -
0		1			\$ -	\$ -	LABORER 1	RT		\$ 71.15	\$ -
					\$ -	\$ -	J. Ramos	OT		\$ -	\$ -
0		1			\$ -	\$ -	LABORER 1	RT	8	\$ 71.15	\$ 569.20
					\$ -	\$ -	G. Zavala	OT		\$ -	\$ -
0		1			\$ -	\$ -	0	RT		\$ -	\$ -
					\$ -	\$ -	0	OT		\$ -	\$ -
0		1			\$ -	\$ -	0	RT		\$ -	\$ -
					\$ -	\$ -	0	OT		\$ -	\$ -
MATERIAL and/or TRUCKING											
Description	No. Units			Unit Cost	Amount						
Material	1.00 LS			\$18.61	\$18.61		INCLUDED				\$ 1,651.20
Material	1.00 LS			\$81.11	\$81.11						\$ -
Material	1.00 LS			\$37.58	\$37.58		INCLUDED				\$ -
	1.00 LS				\$0.00						\$ -
	1.00 LS				\$0.00						\$ -
WORK DONE BY SUBCONTRACTOR and/or SPECIALISTS											
Description	No. Units			Unit Cost	Amount						
	1.00 LS				\$0.00						\$ -
	1.00 LS				\$0.00						\$ -
	1.00 LS				\$0.00						\$ -
TOTAL COST OF LABOR											
										\$	1,651.20
										\$	476.42
										\$	-
										\$	214.66
										\$	47.64
										\$	-
										\$	2,389.92
TOTAL COST OF EQUIPMENT, MATERIALS AND TRUCKING											
TOTAL COST OF SUBCONTRACTOR AND SPECIALISTS											
13% MARK-UP ON LABOR COST											
10% MARK-UP ON EQUIPMENT, MATERIALS AND TRUCKING COST											
7% MARK-UP ON SUBCONTRACTOR AND SPECIALISTS COST											
TOTAL THIS REPORT											



DAILY EXTRA WORK REPORT

NAME OF CONTRACTOR
 ANDERSON PACIFIC
 ADDRESS
 1370 N. WILLOW AVE
 CHICAGO, IL 60642
 PHONE
 408.770.7900

DATE PERFORMED 1-30-2014

CONTRACTOR JOB NO. 2207

CONTRACTOR REPORT NO.

DESCRIPTION OF WORK: Cross Country TRENCH & PUMP INSTALLATION & BACKFILL

NEW WATER MAIN CONSTRUCTION @ 11505 & 11577 ALTA VIA

EQUIP. NO.	EQUIPMENT	HOURS	HOURLY/DAILY RATE	EXTENDED AMOUNTS	P.A. NO.	LABOR	HOURS	HOURLY RATE	EXTENDED AMOUNTS
1020	2020 Utility Truck	8			B	José Gomez	8		
					W	Daniel Ramos	8		
					L	Guillermo Juarez	8		

MATERIAL AND/OR WORK DONE BY SPECIALISTS

NO. OF SPECIALISTS
 4
 628667/5
 628668/5

MATERIAL AND/OR WORK DONE BY SPECIALISTS		EXTENDED AMOUNTS	HOURLY RATE	EXTENDED AMOUNTS
PAYROLL BURDEN AND/OR MARKUPS				
TOTAL COST OF LABOR				

TOTAL COST OF EQUIPMENT, MATERIALS AND WORK

TOTAL A & B
 MARKUP ON EQUIPMENT, MATERIAL AND WORK COST
 TOTAL THIS REPORT

202

SCARBOROUGH BUILDING SUPPLY
12990 HWY 9, BOULDER CREEK
MAIL: P.O. BOX 66599
SCOTT'S VALLEY, CA 95067
PHONE: (831) 338-6467

30 DAYS** + RECEIPT REQUIRED ON
ALL RETURNS / EXCHANGES

Customer No. 12617	Job No. 2202	Purchase Order No. 2202	Reference PO # 2202	Terms 1/10TH, NET 11TH	Clerk SMC	Date 1/30/24	Time 1:42
-----------------------	-----------------	----------------------------	------------------------	---------------------------	--------------	-----------------	--------------

Sold To
* ANDERSON PACIFIC ENGINEERING
1370 NORMAN AVE.
SANTA CLARA, CA 95054
(408) 970-9900

Ship To
* ANDERSON PACIFIC ENGINEERING
1370 NORMAN AVE.
SANTA CLARA, CA 95054
(408) 970-9900

DOC# 628664/5

* INVOICE *

TERM 5/1

SLSPP: 00 DEFAULT
TAX : 500 SALES TAX: S CRUZ COU

SHIPPED	ORDERED	UM	SKU	DESCRIPTION	UNITS	PRICE/PER	EXTENSION
1	EA	47788	COUPLNG GLV 1X1"		1	4.99 /EA	4.99
1	EA	4124707	GALV NIPPLE 1X7		1	6.99 /EA	6.99
1	EA	4124723	NIPPLE GALV 1"X8"		1	6.99 /EA	6.99
REPRINT							
RECEIVED JAN 30 2024 APEC							
						18.61	TAXABLE
							NON-TAXABLE
						18.97	SUBTOTAL
						-1.90	TD DISCOUNT
						1.54	TAX AMOUNT
						18.61	TOTAL AMOUNT

** AMOUNT CHARGED TO STORE ACCOUNT **
(GOMEZ, JOSE)

X Josi Bmw

Received By

1202

SCARBOROUGH BUILDING SUPPLY
12990 HWY 9, BOULDER CREEK
MAIL: P.O. BOX 66599
SCOTT'S VALLEY, CA 95067
PHONE: (831) 338-6467

30 DAYS** + RECEIPT REQUIRED ON
ALL RETURNS / EXCHANGES

Customer No. 12617	Job No. 2202	Purchase Order No. 2202	Reference PO # 2202	Terms 11 10TH, NET 11TH,	Clerk SMC	Date 1/30/24	Time 2:29
-----------------------	-----------------	----------------------------	------------------------	-----------------------------	--------------	-----------------	--------------

Sold To
* ANDERSON PACIFIC ENGINEERING
1370 NORMAN AVE.
SANTA CLARA, CA 95054
(408) 970-9900

Ship To
[Redacted]

DOC# 62866775

* INVOICE *

TERM#581

SLSPR: 00 DEFAULT
TAX : 500 SALES TAX: S CRUZ COU

SHIPPED	ORDERED	UM	SKU	DESCRIPTION	UNITS	PRICE/PER.	EXTENSION
1	EA	4124475	NIPPLE GALV 1"XCLOSE	1	2.49 /EA	2.49	
1	EA	47815	UNION GLV IRON 1X1"	1	17.99 /EA	17.99	
2	EA	21736	ADJ WRENCH VAN CHR 12" AC11EV	2	27.99 /EA	55.98	

REPRINT

RECEIVED
JAN 31 2024
APEC

18	** AMOUNT CHARGED TO STORE ACCOUNT **	81.11	TAXABLE	76.46
	(GOMEZ, JOSE)		NON-TAXABLE	0.00
			SUBTOTAL	76.46
			TD DISCOUNT	-2.05
			TAX AMOUNT	6.70
			TOTAL AMOUNT	81.11

Josie Gomez

X Received By

LWL

SCARBOROUGH HOME CENTER, INC.
9470 HIGHWAY 9, BEN LOMOND 95005
MAIL: P.O. BOX 66599
SCOTT'S VALLEY, CA 95067
PHONE: (831) 336-5142

30 DAYS** + RECEIPT REQUIRED ON
ALL RETURNS / EXCHANGES

Customer No. 12617	Job No. 2202	Purchase Order No. 2202	Reference ALTA VIA WATER MAIN	Terms 11 10TH, NET 11TH,	Clerk CTB	Date 1/30/24	Time 8:25
-----------------------	-----------------	----------------------------	----------------------------------	-----------------------------	--------------	-----------------	--------------

Sold To
* ANDERSON PACIFIC ENGINEERING
1370 NORMAN AVE.
SANTA CLARA, CA 95054
(408) 970-9900

Ship To
[Redacted]

DOC# 419612/2

* INVOICE *

TERM#568

SLSPR: 00 DEFAULT
TAX : 200 SALES TAX: S CRUZ COU

SHIPPED	ORDERED	UM	SKU	DESCRIPTION	UNITS	PRICE/PER	EXTENSION
1	EA	4124293	NIPPLE GALV 3/4"X6"		1	3.99 /EA	3.99
1	EA	4124442	NIPPLE GALV 3/4"X12"		1	6.99 /EA	6.99
1	EA	4124160	NIPPLE GALV 3/4"X2"		1	2.49 /EA	2.49
1	EA	41055	TEE 3/4" GALVANIZED		1	7.99 /EA	7.99 *
4	EA	47804	SQUARE PLUG GLV 3/4"		4	3.99 /EA	15.96
<p>RECEIVED JAN 30 2024 APEC</p>							
<p>** AMOUNT CHARGED TO STORE ACCOUNT **</p>							
<p>(GOMEZ, JOSE)</p>							
						TAXABLE	37.42
						NON-TAXABLE	0.00
						SUBTOTAL	37.42
						TD DISCOUNT	-2.94
						TAX AMOUNT	3.10
						TOTAL AMOUNT	37.58

93

X José González

Received By

Work Performed by:
Work Performed at the direction of:

ANDERSON PACIFIC ENGINEERING CONSTRUCTION, INC.
San Lorenzo Valley Water District

APEC Job #: 2202
Date Performed: 1/30/2024
DEWR #: PCO-10-14

Description of Work:

Set valve boxes and pour collars

EQUIP. NO.	EQUIPMENT	OT/Delay Factor	HOURS		HOURLY RATE	EXTENDED AMOUNTS	LABOR		HOURLY RATE	EXTENDED AMOUNTS
			RT	OT			RT	OT		
1018	FORD F150 PICKUP TRUCK	1	8		\$ 37.61	\$ 300.88	FOREMAN	8	\$ 105.82	\$ 846.56
					\$ -	\$ -	J. Swain	OT	\$ -	\$ -
1026	FORD F250 CREW TRUCK - UTILITY	1	8		\$ 42.39	\$ -	OPERATOR 6	8	\$ 95.42	\$ 763.36
					\$ -	\$ -	T. Thurman	OT	\$ -	\$ -
1020	FORD F250 CREW TRUCK - UTILITY	1	8		\$ 42.39	\$ -	LABORER 1	8	\$ 71.15	\$ 569.20
					\$ -	\$ -	A. Flores	OT	\$ -	\$ -
3022	KOBELCO SK 45SRX-6E	1	8		\$ 48.03	\$ -	LAB APP 3	8	\$ 63.32	\$ -
					\$ -	\$ -	D. Lizaola Ramos	OT	\$ -	\$ -
571	SULLAIR 185 49HP COMPRESSOR	1	8		\$ 28.53	\$ -	LABORER 1	8	\$ 71.15	\$ 569.20
					\$ -	\$ -	F. Flores	OT	\$ -	\$ -
3006	BOBCAT S-650 SKID-STEER LOADER	1	8		\$ 46.72	\$ 373.76	LABORER 1	8	\$ 71.15	\$ 569.20
					\$ -	\$ -	T. Etchison	OT	\$ -	\$ -
0		1			\$ -	\$ -	LABORER 1	8	\$ 71.15	\$ 569.20
					\$ -	\$ -	C. Guidotti	OT	\$ -	\$ -
0		1			\$ -	\$ -	LABORER 1	8	\$ 71.15	\$ 569.20
					\$ -	\$ -	J. Ramos	OT	\$ -	\$ -
0		1			\$ -	\$ -	LABORER 1	8	\$ 71.15	\$ 569.20
					\$ -	\$ -	G. Zavala	OT	\$ -	\$ -
0		1			\$ -	\$ -	0	8	\$ -	\$ -
					\$ -	\$ -	0	OT	\$ -	\$ -
0		1			\$ -	\$ -	0	8	\$ -	\$ -
					\$ -	\$ -	0	OT	\$ -	\$ -
MATERIAL and/or TRUCKING										
Description		No. Units			Unit Cost	Amount				
Material	Scarborough Lumber- 419623/2	1.00 LS			\$95.81	\$95.81	INCLUDED		\$ 4,455.92	
Material	Scarborough Lumber- 628648/5	1.00 LS			\$35.92	\$35.92	INCLUDED		\$ -	
Material	Scarborough Lumber- 628656/5	1.00 LS			\$76.65	\$76.65	INCLUDED		\$ -	
Material	Scarborough Lumber- 628662/5	1.00 LS			\$230.82	\$230.82	INCLUDED		\$ -	
Material	Scotts Valley Sprinkler- 31675/9	1.00 LS			\$183.64	\$183.64	INCLUDED		\$ -	
WORK DONE BY SUBCONTRACTOR and/or SPECIALISTS										
Description		No. Units			Unit Cost	Amount				
		1.00 LS			\$0.00	\$0.00			\$ 4,455.92	
		1.00 LS			\$0.00	\$0.00			\$ 1,297.48	
		1.00 LS			\$0.00	\$0.00			\$ -	
TOTAL COST OF LABOR										
TOTAL COST OF EQUIPMENT, MATERIALS AND TRUCKING										
TOTAL COST OF SUBCONTRACTOR AND SPECIALISTS										
13% MARK-UP ON LABOR COST										
10% MARK-UP ON EQUIPMENT, MATERIALS AND TRUCKING COST										
7% MARK-UP ON SUBCONTRACTOR AND SPECIALISTS COST										
TOTAL THIS REPORT										
\$ 6,462.42										

RCT- PFI #17



DAILY EXTRA WORK REPORT

RELISE INFORMATION
 PROJECT: Anderson Pacific
 ADDRESS: 1370 Dismal Ave
 CITY: San Jose, Costa Rica
 PHONE: 408 777 7700

DATE PERIOD: 1-31-2024

CONTRACTOR (P/N #): 2202
 CONTRACTOR REPORT NO:

CONTRACTOR NAME: San Lorenzo Water District

CONTRACTOR ADDRESS: San Lorenzo Water District

EQUIP. NO.	EQUIPMENT	HOURS	HOURS/DAILY RATE	EXTENDED AMOUNTS	P.A. NO.	LABOR	HOURS	HOURLY RATE	EXTENDED AMOUNTS	MATERIAL AND/OR WORK DONE BY SPECIALISTS		MATERIAL AND/OR WORK	
										ESTIMATED	ACTUAL	ESTIMATED	ACTUAL
1018 3006	Excavator Backhoe	000			F de Sosa					628662/5	628662/5		
					06 Tommy Therman					31675/9	31675/9		
					L1 ANA FLORES					628656/5	628656/5		
					L1 CHARIC GONDI					419623/2	419623/2		
					L1 CHEBY RAMOS					628666/5	628666/5		
					L1 TIM ERIKSON								
					L1 FRANCISCO FLORES								
MATERIAL AND/OR WORK DONE BY SPECIALISTS										SUB TOTAL			
										PAYROLL BURDEN AND/OR MARKUPS			
										TOTAL COST OF LABOR			
										TOTAL A & B			
										MARKUP OR EQUIPMENT, MATERIAL AND WORK COST			
										TOTAL THIS REPORT			

100

SCARBOROUGH HOME CENTER, INC.
9470 HIGHWAY 9, BEN LOMOND 95005
MAIL: P.O. BOX 66599
SCOTT'S VALLEY, CA 95067
PHONE: (831) 336-5142

30 DAYS** + RECEIPT REQUIRED ON
ALL RETURNS / EXCHANGES

Customer No. 12617	Job No.	Purchase Order No. 2202	Reference PO # 2202	Terms 1% 10TH, NET 11TH	Clark HRM	Date 1/30/24	Time 9:23
-----------------------	---------	----------------------------	------------------------	----------------------------	--------------	-----------------	--------------

Sold To
ANDERSON PACIFIC ENGINEERING
1370 NORMAN AVE.
SANTA CLARA, CA 95054
(408) 970-9900

Sold To
ANDERSON PACIFIC ENGINEERING
1370 NORMAN AVE.
SANTA CLARA, CA 95054
(408) 970-9900

DOC# 419623/2

* INVOICE *

TERM#566

SLSPR: 00 DEFAULT
TAX : 200 SALES TAX: S CRUZ COU

SHIPPED	ORDERED	UM	SKU	DESCRIPTION	UNITS	PRICE/PER	EXTENSION
5	BG	SAK60	QUIKRETE CONCRETE MIX 60#	5	6.59 /BG	32.95 *	
5	BG	SAKMM60	QUIKRETE MASON MPTP TYPE S 60#	5	10.99 /BG	54.95 *	
REPRINT							
RECEIVED JAN 30 2024 APEC							
** AMOUNT CHARGED TO STORE ACCOUNT **							95.81
(FROST, ANDON)							
TAXABLE							87.90
NON-TAXABLE							0.00
SUBTOTAL							87.90
TAX AMOUNT							7.91
TOTAL AMOUNT							95.81



X _____
Received By

202

PAGE NO 1

SCARBOROUGH BUILDING SUPPLY
12990 HWY 9, BOULDER CREEK
MAIL: P.O. BOX 66599
SCOTT'S VALLEY, CA 95067
PHONE: (831) 338-6467

30 DAYS** + RECEIPT REQUIRED ON
ALL RETURNS / EXCHANGES

Customer No. 12617	Job No.	Purchase Order No. 2202	Reference PO # 2202	Terms 15 10TH, NET 11TH.	Clerk MAC	Date 1/30/24	Time 2:43
-----------------------	---------	----------------------------	------------------------	-----------------------------	--------------	-----------------	--------------

Ship to

Sold to
ANDERSON PACIFIC ENGINEERING
1370 NORMAN AVE.
SANTA CLARA, CA 95054
(408) 970-9900

DC# 628648/5

* INVOICE *

TERMS582

SLSPR: 00 DEFAULT
TAX : 500 SALES TAX: S CRUZ COU

SHIPPED	ORDERED	UM	SKU	DESCRIPTION	UNITS	PRICE/PER	EXTENSION
5	BG	SAK60		QUIKRETE CONCRETE MIX 60#	5	6.59 /BG	32.95 *
REPRINT							
RECEIVED JAN 30 2024 APC							
					63	** AMOUNT CHARGED TO STORE ACCOUNT **	
						(AMC, FLORES)	
						TAXABLE	32.95
						NON-TAXABLE	0.00
						SUBTOTAL	32.95
						TAX AMOUNT	2.97
						TOTAL AMOUNT	35.92

X 
Received By

200

SCARBOROUGH BUILDING SUPPLY
 12990 HWY 9, BOULDER CREEK
 MAIL: P.O. BOX 66599
 SCOTT'S VALLEY, CA 95067
 PHONE: (831) 338-6467

30 DAYS** * RECEIPT REQUIRED ON
 ALL RETURNS / EXCHANGES

Customer No. 12617	Job No. 2202	Purchase Order No. 2202	Reference ANASTASIO FLORES	Terms 11 10TH, NET 11TH,	Clerk SMC	Date 1/30/24	Time 10:53
-----------------------	-----------------	----------------------------	-------------------------------	-----------------------------	--------------	-----------------	---------------

Sold To
 * ANDERSON PACIFIC ENGINEERING
 1370 NORMAN AVE.
 SANTA CLARA, CA 95054
 (408) 970-9900

Ship To

DOC# 628656/5

 * INVOICE *

 SLSPR: 00 DEFAULT
 TAX : 500 SALES TAX: S CRUZ COU

SHIPPED	ORDERED	UM	SKU	DESCRIPTION	UNITS	PRICE/PER	EXTENSION
4	BG	SAK60	QUIKRETE CONCRETE MIX 60#		4	6.59 /BG	26.36 *
4	BG	SAKMM60	QUIKRETE MASON MRTR TYPE S 60#		4	10.99 /BG	43.96 *

REPRINT

RECEIVED
 JAN 30 2024
 APEC

77	** AMOUNT CHARGED TO STORE ACCOUNT **	76.65	TAXABLE	70.32
	(ANDERSON, PETER)		NON-TAXABLE	0.00
			SUBTOTAL	70.32
			TAX AMOUNT	6.33
			TOTAL AMOUNT	76.65

APLD
 Received By

701

SCARBOROUGH BUILDING SUPPLY
12990 HWY 9, BOULDER CREEK
MAIL: P.O. BOX 66599
SCOTT'S VALLEY, CA 95067
PHONE: (831) 338-6467

30 DAYS** * RECEIPT REQUIRED ON
ALL RETURNS / EXCHANGES

Customer No. 12617	Job No. 2202	Purchase Order No. 2202	Reference ANASTASIO	Terms 11/10TH, NET 11TH,	Class SMC	Date 1/30/24	Time 1:04
-----------------------	-----------------	----------------------------	------------------------	-----------------------------	--------------	-----------------	--------------

Sold To
* ANDERSON PACIFIC ENGINEERING
1370 NORMAN AVE.
SANTA CLARA, CA 95054
(408) 970-9900

Ship To

DOC# 62862/5

* INVOICE *

TERMS582
SISPR: 00 DEFAULT
TAX : 500 SALES TAX: S CRUZ COU

SHIPPED	ORDERED	QTY	SKU	DESCRIPTION	UNITS	PRICE/PER	EXTENSION
10	BG	SAK60	QUIKRETE CONCRETE MIX 60#	10	6.59 /BG	65.90 *	
10	BG	SAKMM60	QUIKRETE MASON MPTR TYPE S 60#	10	10.99 /BG	109.90 *	
4	EA	4537130	VALVE ACCESS BX7"W/COVER	4	9.90 /EA	35.96	
<p>RECEIVED JAN 30 2024 APEC</p>							
						TAXABLE	215.76
						NON-TAXABLE	0.00
						SUBTOTAL	215.76
						T.D DISCOUNT	-4.00
						TAX AMOUNT	19.06
						TOTAL AMOUNT	230.82

** AMOUNT CHARGED TO STORE ACCOUNT **
(ANDERSON, PETER)

X *APEC*
Received By

SCOTTS VALLEY SPRINKLER
5010 SCOTTS VALLEY DR., SV, CA
MAIL: P.O. BOX 66837
SCOTTS VALLEY CA. 95067
PHONE: (831) 438-6450
 30 DAYS** + RECEIPT REQUIRED ON RETURNS
 RETURNS ARE SUBJECT TO A RESTOCKING FEE!

CUST NO: 9435 JOB NO: 000 PURCHASE ORDER: 2202 REFERENCE: PO # 2202 TERMS: 2% 10TH, NET 11TH CLERK: TMP DATE / TIME: 1/29/24 3:42

TERMINAL: 913

SOLD TO:
 ANDERSON PACIFIC ENG.
 1370 NORMAN AVENUE

 SANTA CLARA CA 95054-2047
 408-870-9900

SHIP TO:

TAX: S01 TAX SCOTTS VALLEY SV

INVOICE:31675 /9

LINE	SHIPPED	ORDERED	UM	SKU	DESCRIPTION	SUGG	UNITS	PRICE/ PER	EXTENSION
1	20	20	EA	8EB	8" ROUND VALVE BOX W/COVER 15/9		20	6.99 /EA	139.80 *
2	1	1	EA	4406716	ADAPTR 1"MPT SCH40 10 PK		1	9.99 /EA	9.99 *
3	4	4	EA	43145	BUSHING 1"X3/4" SXSSCH40		4	1.99 /EA	7.96
4	2	2	EA	44901	ELBOW 90 PVC40 1" SXMPT		2	4.79 /EA	9.58

RECEIVED
 JAN 30 2024
 APEC

TAXABLE 167.33 SUBTOTAL 167.33
 NON-TAXABLE 0.00

(JOSE JUAREZ)
 ** AMOUNT CHARGED TO STORE ACCOUNT ** 183.64
 763

TAX AMOUNT 16.31
TOTAL 183.64

TOT WT: 1.40

x Jose Juarez
 Received By

APEC Billing Summary Sheet

Bill To: SLWWD
 Invoice #:
 Billing Period: February, 2023

Job: 2202
 Date:

Item#	Description	Date	Qty	Unit Price	% Billed	Price
1	PCO-10-15	2/12/2024	1	\$ 4,437.83	100%	\$ 4,437.83
2	PCO-10-16	2/13/2024	1	\$ 7,307.63	100%	\$ 7,307.63
3	PCO-10-17	2/15/2024	1	\$ 7,828.10	100%	\$ 7,828.10
4	PCO-10-18	2/16/2024	1	\$ 8,493.85	100%	\$ 8,493.85
5	PCO-10-19	2/21/2024	1	\$ 7,013.91	100%	\$ 7,013.91
6	PCO-10-20	2/22/2024	1	\$ 6,047.11	100%	\$ 6,047.11
7	PCO-10-21	2/23/2024	1	\$ 9,132.97	100%	\$ 9,132.97
8	PCO-10-22	2/29/2024	1	\$ 2,082.18	100%	\$ 2,082.18
9	PCO-10-23	3/4/2024	1	\$ 5,851.14	100%	\$ 5,851.14
10			1		100%	\$ -
11			1		100%	\$ -
12			1		100%	\$ -
13			1		100%	\$ -
14			1		100%	\$ -
15			1		100%	\$ -
16			1		100%	\$ -
17			1		100%	\$ -
18			1		100%	\$ -
19			1		100%	\$ -
20			1		100%	\$ -
21			1		100%	\$ -
22			1		100%	\$ -
23			1		100%	\$ -
24			1		100%	\$ -
25			1		100%	\$ -
26			1		100%	\$ -
27			1		100%	\$ -
28			1		100%	\$ -
29			1		100%	\$ -
30						

Sub Total: \$ 58,194.73

Total \$ 58,194.73

Description of Work: Layout, clear and grub uphill trench, hand trench from new meter boxes to existing meter boxes or authorized tie-in point backfill trench

EQUIP. NO.	EQUIPMENT	OT/Delay Factor	HOURS		HOURLY RATE	EXTENDED AMOUNTS	LABOR	HOURS		HOURLY RATE	EXTENDED AMOUNTS
			RT	OT				RT	OT		
1018	FORD F150 PICKUP TRUCK	1	RT	1	\$ 37.61	\$ 37.61	49	RT	8	\$ 105.82	\$ 846.56
			OT		\$ -	\$ -		OT		\$ -	\$ -
94	FORD F150 PICKUP TRUCK	1	RT		\$ 37.61	\$ -	1	RT	8	\$ 71.15	\$ 569.20
			OT		\$ -	\$ -		OT		\$ -	\$ -
7006	FORD F650 BOBTAIL DUMP TRUCK - 5 CY	1	RT		\$ 73.34	\$ -	1	RT	8	\$ 71.15	\$ 569.20
			OT		\$ -	\$ -		OT		\$ -	\$ -
3022	KOBELCO SK 45SRX-6E	1	RT		\$ 48.03	\$ -	LA3	RT	8	\$ 63.32	\$ 506.56
			OT		\$ -	\$ -		OT		\$ -	\$ -
0		1	RT		\$ -	\$ -	1	RT	8	\$ 71.15	\$ 569.20
			OT		\$ -	\$ -		OT		\$ -	\$ -
0		1	RT		\$ -	\$ -	1	RT	8	\$ 71.15	\$ 569.20
			OT		\$ -	\$ -		OT		\$ -	\$ -
0		1	RT		\$ -	\$ -	0	RT		\$ -	\$ -
			OT		\$ -	\$ -		OT		\$ -	\$ -
0		1	RT		\$ -	\$ -	0	RT		\$ -	\$ -
			OT		\$ -	\$ -		OT		\$ -	\$ -
0		1	RT		\$ -	\$ -	0	RT		\$ -	\$ -
			OT		\$ -	\$ -		OT		\$ -	\$ -
0		1	RT		\$ -	\$ -	0	RT		\$ -	\$ -
			OT		\$ -	\$ -		OT		\$ -	\$ -
MATERIAL and/or TRUCKING											
Description	No. Units	Unit Cost	Amount								
Material	1.00 LS	\$0.00	\$0.00								
Material	1.00 LS	\$190.21	\$190.21								
Material	1.00 LS	\$77.65	\$77.65								
	1.00 LS	\$0.00	\$0.00								
	1.00 LS	\$0.00	\$0.00								
WORK DONE BY SUBCONTRACTOR and/or SPECIALISTS											
Description	No. Units	Unit Cost	Amount								
	1.00 LS	\$0.00	\$0.00								
	1.00 LS	\$0.00	\$0.00								
	1.00 LS	\$0.00	\$0.00								
TOTAL COST OF EQUIPMENT, MATERIALS AND TRUCKING											
TOTAL COST OF SUBCONTRACTOR AND SPECIALISTS											
TOTAL COST OF LABOR											
										Sub-Total Labor RT	\$ 3,629.92
										Labor Surcharge RT	\$ -
										Sub-Total Labor OT	\$ -
										Labor Surcharge OT	\$ -
										Subsistence	\$ -
TOTAL THIS REPORT											
										\$ 3,629.92	\$ 3,629.92
										\$ 305.47	\$ 305.47
										\$ -	\$ -
										\$ 471.89	\$ 471.89
										\$ 30.55	\$ 30.55
										\$ -	\$ -
										\$ 4,437.83	\$ 4,437.83

13% MARK-UP ON LABOR COST
10% MARK-UP ON EQUIPMENT, MATERIALS AND TRUCKING COST
7% MARK-UP ON SUBCONTRACTOR AND SPECIALISTS COST



P.O. Box 50001
 Watsonville, CA 95077-5001
 (831) 768-2000

Customer: 10228

Anderson Pacific Engin Const Inc
 1370 Norman Avenue
 Santa Clara, CA 95054

Invoice No: 2142479
 Invoice Date: 02/17/2024
 Job No: 2202
 Order No: 959149
 Job PO No:
 Job Name: 2202 Alta Via Pipeline Replacement Brook
 Job Street: 100 Lockwood Ln
 Job City: Santa Cruz

Aggregate and Asphalt

Ticket	Date	Truck	Qty	Product	Price	Amount	Freight	Additional	Tax	Total	
Location							Price	Charges	Amount		
Product: 271 - Utility Trench Sand											
15131266	02/12/2024	28751	6.38 Tons	25.00		159.50		15.00	9.00%	15.71	190.21
Quail Hollow											
Totals for Product 271 on 02/12/2024			6.38			158.50	0.00	15.00		15.71	190.21

Summary of Additional Charges

Environmental Recovery Fee	15.00
----------------------------	-------

RECEIVED
 FEB 21 2024
 APEC

	Product	Freight	Additional	Tax	Total
Invoice Totals	158.50	0.00	15.00	15.71	190.21

For questions, or additional info, contact Customer Service at (831) 768-2120 or CustomerServiceAll@graniterock.com

SHORT PAY POLICY

Our philosophy of total customer satisfaction can be summarized with the following statement:
 If you are not satisfied for any reason, don't pay us for it.

That means that if any part of this invoice is incorrect or if you were unhappy with the products or services received from this transaction, let us know right now. Simply scratch out the related line item, write a brief note about the problem, and return a copy of this invoice along with your check for the remaining balance. Someone will contact you immediately to resolve the problem.

Please Make Checks Payable to:

Granite Rock Company
 P.O. Box 50001
 Watsonville, CA 95077-5001

Customer No: 10228
 Invoice No: 2142479
 Invoice Date: 02/17/2024

Sold To: Anderson Pacific Engin Const Inc
 1370 Norman Avenue
 Santa Clara, CA 95054

Total Due by 03/25/2024 \$190.21
 Deduct Discount Amount if Received by 03/10/2024 \$1.74

Payment Enclosed

If haul charges are indicated separately above, the passage of material is at the plant, with delivery provided by Graniterock for customer's account.

2/12/2024

GRANITEROCK 140 15131266

Quail Hollow
405 Quail Hollow Road, Felton CA 95018
(831) 471-3480

Customer Information

Name: Anderson Pacific Engr Const Inc 10228
Job: 2202 Alta Via Pipeline Repts Job#: 2202
Order #: 959149 PO#:

Truck Information

GX28751 RF Tag #: 28751
Type: Others
Broker: OUTSIDE
License: ANDERSON

Weight Information (Driver in Vehicle)

	Pounds	M Tons	Tons
(Driver On) Tare:	13,920	6.31	6.96
Scale: Truck Scale 1 - Branch 140			

Material	271	Utility Trench Sand	Pounds	M Tons	Tons
Net:			12,760	5.79	6.38
(Driver On) Gross:			26,680	12.10	13.34
Scale:		Scale 2 - Outbound Reader			

Product Information

Code	Description	Tons
271	Utility Trench Sand	6.38
ERF	Environmental Recovery Fee	1.00

Total Today	Loads	Tons
271	1	6.38

Job Management Information

Time (Min)	Current	Job Average Today	To Date
Gate to Gate	37.0	37.0	21.3
Return Time	0.0		
Time In: 11:22:05	Ticketed:	11:59:05	

Granite Rock Company: Weighmaster

Weighed by: Sydney Fischer, Deputy

Trucker:

Received: 

WEIGHMASTER CERTIFICATE

THIS IS TO CERTIFY that the following described commodity was weighed, measured, or counted, by a weighmaster, whose signature is on this certificate, who is a recognized authority of accuracy, as prescribed by chapter 7 (commencing with Section 12700) of Division 5 of the California Business and Professions Code, administered by the Division of Measurement Standards of the California Department of Food and Agriculture.

V 062016

INVOICE



PLEASE MAIL REMITTANCE TO:

Granite Construction Company
PO Box 742478
Los Angeles, CA 90074-2478

INVOICE DATE: 2/12/2024

Bill To:

ANDERSON PACIFIC ENGINEERING CONSTRUCT
1370 NORMAN AVENUE
SANTA CLARA CA 95054-2056
AP@ANDPAC.COM

ORDER NO.	CUSTOMER NO.	PLANT	INVOICE NO.
282857	120862	FELTON RAP 100323	2654770
ORIGINAL INVOICE #		JOB ADDRESS	DATE OF SALE
		SLVWD ALTA VIA PIPELINE REPLACEMENT ALTA VIA BROOKDALE CA 95007	2/12/2024
			PO #
			2202

A LATE FEE OF 1.5% PER MONTH (18% PER ANNUM) WILL BE APPLIED ON PAST DUE BALANCES

A CREDIT CARD FEE OF 2.3% WILL BE APPLIED TO ALL CREDIT CARD PAYMENTS MADE MORE THAN 10 BUSINESS DAYS AFTER THE INVOICE DATE ABOVE

TICKET NUMBER	TICKET DATE	MATERIAL DESCRIPTION	QTY	UNIT PRICE	EXTENDED AMOUNT	FOB	TAX RATE AREA
31834933	2/12/2024	1823 - 3/4" RECYCLED AGGREGATE BASE	5.480 TN	13.000	\$71.24	P	V050870000
	TOTAL:	1823 - 3/4" RECYCLED AGGREGATE BASE	5.480 TN		\$71.24		

RECEIVED
FEB 16 2024
APEC

TERMS: A/R Net 30 Days

The prevailing party shall be entitled to reasonable attorney's fees and costs in any action to collect the amounts due hereunder.
Note: If haul charges are indicated separately above, then the title passage of materials is at the plant, with delivery provided for customers.
 The environmental fee is not a tax, surcharge, or fee mandated by or remitted to any governmental or regulatory agency but used to recover direct and indirect costs for Granite and its subsidiaries operations to be conducted in an environmentally sustainable manner.
 For any question regarding this billing, please call (831)768-4002.

TOTAL FREIGHT	00
MATERIAL	71.24
FEES	.00
SALES TAX	6.41

FOB: P=PLANT J=JOB

FOR OFFICIAL USE ONLY

INVOICE TOTAL

WARNING: THIS PRODUCT CONTAINS A CHEMICAL KNOWN TO THE STATE OF CALIFORNIA TO CAUSE CANCER, BIRTH DEFECTS OR OTHER REPRODUCTIVE HARM. MSDS SHEETS AVAILABLE AT WWW.GRANITECONSTRUCTION.COM/MSDS OR BY CONTACTING YOUR LOCAL OFFICE.

\$77.65

9909



Felton Rap
1800 Felton Quarry Road
Felton, CA 95018
831-335-3445

Customer: **ANDERSON PACIFIC ENGINEERING**
120862
Order ID: 282857
Job/PO#: 2202
Cost Code
Location: **SLVWD ALTA VIA PIPELINE REPLACEMENT**
ALTA VIA

Vehicle: 53882U3 Anderson Pacific 7009
License: | |
Carrier:
Product: 1823 3/4"RECYCLED AGGREGATE BASE

	Pounds	Metric Tons	Tons
Gross	25,060	11.37	12.53
Tare	14,100	6.40	7.05
Net	10,960	4.97	5.48
Scale:	1		

Comments:

FOB: PICK-UP

This Load: 5.48 TONS

Load No: 1
Shipped: 5.48 TONS

Weighmaster: Granite Construction Company
Deputy: Michelle Ceresa
Driver In Vehicle

WEIGHMASTER CERTIFICATE

THIS IS TO CERTIFY that the following described commodity was weighed, measured, or counted by a weighmaster, whose signature is on this certificate, who is a recognized authority of accuracy, as prescribed by Chapter 7 (commencing with Section 12700) of Division 5 of the California Business and Professions Code, administered by the Division of Measurement Standards of the California Department of Food and Agriculture.

Accepted by: _____

WARNING: Cancer and Reproductive Harm www.P65Warnings.ca.gov. See Reverse.



Felton Rap
1800 Felton Quarry Road
Felton, CA 95018
831-335-3445

Customer: **ANDERSON PACIFIC ENGINEERING**
120862
Order ID: 282857
Job/PO#: 2202
Cost Code
Location: **SLVWD ALTA VIA PIPELINE REPLACEMENT**
ALTA VIA

Vehicle: 53882U3 Anderson Pacific 7009
License: | |
Carrier:
Product: 1823 3/4"RECYCLED AGGREGATE BASE

	Pounds	Metric Tons	Tons
Gross	25,060	11.37	12.53
Tare	14,100	6.40	7.05
Net	10,960	4.97	5.48
Scale:	1		

Comments:

FOB: PICK-UP

This Load: 5.48 TONS

Load No: 1
Shipped: 5.48 TONS

Weighmaster: Granite Construction Company
Deputy: Michelle Ceresa
Driver In Vehicle

WEIGHMASTER CERTIFICATE

THIS IS TO CERTIFY that the following described commodity was weighed, measured, or counted by a weighmaster, whose signature is on this certificate, who is a recognized authority of accuracy, as prescribed by Chapter 7 (commencing with Section 12700) of Division 5 of the California Business and Professions Code, administered by the Division of Measurement Standards of the California Department of Food and Agriculture.

Accepted by: _____

WARNING: Cancer and Reproductive Harm www.P65Warnings.ca.gov. See Reverse.

Description of Work: Finish new service line connection and demo/ remove existing meters and finish backfill @ 11555 & 11565 Alta Via

EQUIP. NO.	EQUIPMENT	OT/Delay Factor	HOURS		HOURLY RATE	EXTENDED AMOUNTS	LABOR	HOURS		HOURLY RATE	EXTENDED AMOUNTS
			RT	OT				RT	OT		
1018	FORD F150 PICKUP TRUCK	1	8		\$ 37.61	\$ 300.88	FOREMAN	8		\$ 105.82	\$ 846.56
							J. Swain				
1020	FORD F250 CREW TRUCK - UTILITY	1	8		\$ 42.39	\$ 339.12	CONSTRUCTION SPECIALIST	8		\$ 71.93	\$ 575.44
							J. Gomez				
7006	FORD F650 BOBTAIL DUMP TRUCK - 5 CY	1	8		\$ 73.34	\$ -	LABORER 1	8		\$ 71.15	\$ 569.20
							N. Agrifolio				
3022	KOBELCO SK 45SRX-6E	1	8		\$ 48.03	\$ -	LAB APP 3	8		\$ 63.32	\$ 506.56
							D. Lizaola Ramos				
0		1	8		\$ -	\$ -	LABORER 1	8		\$ 71.15	\$ 569.20
							M. Johns				
0		1	8		\$ -	\$ -	LABORER 1	8		\$ 71.15	\$ 569.20
							Chance Guidotti				
0		1	8		\$ -	\$ -		8		\$ -	\$ -
0		1	8		\$ -	\$ -		8		\$ -	\$ -
0		1	8		\$ -	\$ -		8		\$ -	\$ -
0		1	8		\$ -	\$ -		8		\$ -	\$ -
0		1	8		\$ -	\$ -		8		\$ -	\$ -
MATERIAL and/or TRUCKING											
Description	No. Units	Unit Cost	Amount								
Material Scarborough- 420158/2, 420178/2	1.00 LS	\$1,848.60	\$1,848.60								
Material Iconix- U2414005646	1.00 LS	\$261.58	\$261.58								
Material Ferguson- 1841461	1.00 LS	\$157.79	\$157.79								
	1.00 LS	\$0.00	\$0.00								
	1.00 LS	\$0.00	\$0.00								
WORK DONE BY SUBCONTRACTOR and/or SPECIALISTS											
Description	No. Units	Unit Cost	Amount								
	1.00 LS	\$0.00	\$0.00								
	1.00 LS	\$0.00	\$0.00								
	1.00 LS	\$0.00	\$0.00								
TOTAL COST OF EQUIPMENT, MATERIALS AND TRUCKING											
TOTAL COST OF SUBCONTRACTOR AND SPECIALISTS											
				TOTAL COST OF LABOR							
				\$ 3,636.16							
				\$ 2,907.97							
				\$ -							
				\$ 472.70							
				\$ 290.80							
				\$ -							
				\$ 7,307.63							

13% MARK-UP ON LABOR COST
10% MARK-UP ON EQUIPMENT, MATERIALS AND TRUCKING COST
7% MARK-UP ON SUBCONTRACTOR AND SPECIALISTS COST

TOTAL THIS REPORT

9909

ANDERSON PACIFIC

Engineering Construction, Inc.

BILLING INFORMATION:

NAME: ANDERSON PACIFIC
 ADDRESS: 1370 NORMAN AVE
 CITY/STATE/ZIP: SANTA CLARA, CA
 PHONE: 408.970.9900

188

DAILY EXTRA WORK REPORT

DATE PERFORMED 2/13/2024

WORK PERFORMED AT THE DIRECTION OF: SAV LOPEZ WATER DISTRICT

CONTRACTOR JOB NO. 2202

CONTRACTOR REPORT NO.

DESCRIPTION OF WORK: FINISH NEW SERVICE LINE CONNECTION AND DEMO/RENDUE

EXISTING METERS AND FINISH BACKFILL @ 115555 + 11565 ALTA U1A

EQUIP NO.	EQUIPMENT	HOURS	HOURLY/DAILY RATE	EXTENDED AMOUNTS	P. R. NO.	LABOR	HOURS	HOURLY RATE	EXTENDED AMOUNTS
1018	Ford F-150	8			F	JOE SWAIN	8		
1020	Utility Truck	8			CS	JOSE GOMEZ	8		
					LI	NATHAN ABRILFOLIO	8		
					LI	DANIEL RAMOS	8		
					LI	MIKE JOHNS	8		
					LI	CLAUDE GUIDOTTI	8		

MATERIAL AND/OR WORK DONE BY SPECIALISTS		SUB-TOTAL	
DESCRIPTION	NO. UNIT	UNIT COST	EXTENDED
SCARABOUGHT - 420158/2	420193/2	42018/2	
ICONIX - 42414 005696			
Ferguson - 18991461			
Ferguson - 1891461			
TOTAL COST OF EQUIPMENT, MATERIALS AND WORK			A
TOTAL COST OF LABOR			B

ACCEPTED: _____ CONTRACTOR'S REPRESENTATIVE

OWNER/AGENT _____

TOTAL A & B _____

MARKUP ON EQUIPMENT, MATERIAL AND WORK COST _____ %

TOTAL THIS REPORT

SCARBOROUGH HOME CENTER, INC.
9470 HIGHWAY 9, BEN LOMOND 95005
MAIL: P.O. BOX 66599
SCOTT VALLEY, CA 95067
PHONE: (831) 336-5142

30 DAYS** + RECEIPT REQUIRED ON
 ALL RETURNS / EXCHANGES

9909

189

Customer No. 12617	Job No. 2202	Purchase Order No. 2202	PO # 2202	Reference	Terms 1% 10TH, NET 11TH,	Clerk JEM	Date 2/13/24	Time 1:35
-----------------------	-----------------	----------------------------	-----------	-----------	-----------------------------	--------------	-----------------	--------------

Sold To
 * ANDERSON PACIFIC ENGINEERING
 1370 NORMAN AVE.
 SANTA CLARA, CA 95054
 (408) 970-9900

Ship To

DOC# 420193/2

 * INVOICE *

 SLSPR: 00 DEFAULT
 TAX : 200 SALES TAX: S CRUZ COU

SHIPPED	ORDERED	UM	EA	SKU	DESCRIPTION	UNITS	PRICE/PER	EXTENSION	
1		EA	4873022		4" NO-HUB COUPLING 3/3	1	8.99 /EA	8.99	
** AMOUNT CHARGED TO STORE ACCOUNT ** (SWAIN, JOE)									
							8.82	TAXABLE	8.99
								NON-TAXABLE	0.00
								SUBTOTAL	8.99
								TD DISCOUNT	-0.90
								TAX AMOUNT	0.73
								TOTAL AMOUNT	8.82

Handwritten signature

X
 Received By _____

SCARBOROUGH HOME CENTER, INC.
9470 HIGHWAY 9, BEN LOMOND 95005
MAIL: P.O. BOX 66599
SCOTT'S VALLEY, CA 95067
PHONE: (831) 336-5142

30 DAYS** + RECEIPT REQUIRED ON
 ALL RETURNS / EXCHANGES

9909

Customer No. 12617	Job No.	Purchase Order No. 2202	Reference ALTA VIA WATER MAIN	Terms 1% 10TH, NET 11TH,	Clerk CTB	Date 2/13/24	Time 8:18
-----------------------	---------	----------------------------	----------------------------------	-----------------------------	--------------	-----------------	--------------

Sold To
 * ANDERSON PACIFIC ENGINEERING
 1370 NORMAN AVE.
 SANTA CLARA, CA 95054
 (408) 970-9900

Ship To

DOC# 420158/2

 * INVOICE *

 SLSPR: 00 DEFAULT
 TAX : 200 SALES TAX: S CRUZ COU
 TERM#568

SHIPPED	ORDERED	UM	SKU	DESCRIPTION	UNITS	PRICE/PER	EXTENSION
1		EA	4606141	TRU-BLU	1	23.99 /EA	23.99 *
1		EA	2017816	MFL CUT WHL 4.5" XP 50K	1	12.99 /EA	12.99 *
3		EA	2555274	TYPE 1 CUTWHEEL 4.5X.045	3	4.99 /EA	14.97
2		EA	4000283	THREAD TAPE 1429X1/2"BLU	2	6.99 /EA	13.98 *
1		EA	4124020	NIPPLE GALV 1/2"X5.5"	1	3.79 /EA	3.79
3		EA	47800	RED COUPLNG GLV 1X3/4"	3	5.99 /EA	17.97
2		EA	4124533	NIPPLE GALV 1"X3.5"	2	2.99 /EA	5.98
1		EA	4124160	NIPPLE GALV 3/4"X2"	1	2.49 /EA	2.49
1		EA	4124061	GALV NIPPLE 1/2X9	1	4.99 /EA	4.99
1		EA	406150	1/2" DRESSER COUPLING	1	55.79 /EA	55.79 *
661					165.59	TAXABLE	156.94
						NON-TAXABLE	0.00
						SUBTOTAL	156.94
						TD DISCOUNT	-5.02
						TAX AMOUNT	13.67
						TOTAL AMOUNT	165.59

** AMOUNT CHARGED TO STORE ACCOUNT **

(GOMEZ, JOSE)

Jose Gomez

X

Received By

SCARBOROUGH HOME CENTER, INC.
9470 HIGHWAY 9, BEN LOMOND 95005
MAIL: P.O. BOX 66599
SCOTT'S VALLEY, CA 95067
PHONE: (831) 336-5142

30 DAYS** + RECEIPT REQUIRED ON
 ALL RETURNS / EXCHANGES

191

Customer No. 12617	Job No.	Purchase Order No. 2202	PO # 2202	Reference	Terms 1 & 10TH, NET 11TH,	Clerk JRP	Date 2/13/24	Time 11:49
-----------------------	---------	----------------------------	-----------	-----------	------------------------------	--------------	-----------------	---------------

Sold To
 * ANDERSON PACIFIC ENGINEERING
 1370 NORMAN AVE.
 SANTA CLARA, CA 95054
 (408) 970-9900

Ship To

DOC# 420178/2

 * INVOICE *

 SLSPR: 00 DEFAULT
 TAX : 200 SALES TAX: S CRUZ COU

SHIPPED	ORDERED	UM	SKU	DESCRIPTION	UNITS	PRICE/PER	EXTENSION	
10	BG	SAKB	60#	QUIKRETE BLACKTOP MIX	10	16.99 /BG	169.90 *	
** AMOUNT CHARGED TO STORE ACCOUNT **							185.19	169.90
(SWAIN, JOE)							TAXABLE	0.00
							NON-TAXABLE	169.90
							SUBTOTAL	15.29
							TAX AMOUNT	185.19
							TOTAL AMOUNT	

[Handwritten Signature]
 Received By

X

2202

ICONIX Waterworks (US) Inc.
1359 DAYTON ST BLDG A
Salinas, CA 93901-4404
USA
Tel: 831-757-7776
Fax: 831-757-7832
www.iconixww.com

INVOICE



Invoice Number: U2416004902

Invoice Date: 02/13/24

Page: 1

Bill To: ANDERSON PACIFIC
1370 NORMAN AVENUE
SANTA CLARA, CA 95054
USA

RECEIVED
FEB 14 2024
APEC

Ship To: ICONIX Waterworks (US) Inc.
1359 DAYTON ST BLDG A
SALINAS, CA 93901-4404
USA

Cust No.	ANDPAC	Ship Via		P.O. Date	02/13/24
Terms	Net 30 daysA	Ship Date	02/13/24	P.O. Number	2202
Due Date	03/14/24	SalesPerson	Pete Rodriguez	Our Order No.	U2412005980
PST Exempt No.		Creator	SALNSPOS2	Cust Job Name	BOULDER CREEK
GST Exempt No.		Posted By	LDAVILA	Ordered By:	DANIEL

Item No.	Customer Item	Description	Unit	Order Qty	Quantity	Unit Price	Total Price
PP10CTS09100250		1 PE 4710 BLACK CTS SDR 9 100' 250 PSI	FOOT	100	100	0.67	67.00
WWKV43444WGNL		1 FORD GJ CTS X MTR AMS NL	EACH	2	2	86.21	172.42

Taxable Amount	239.42	Tax Exempt Amount	0.00	Subtotal:	239.42
				Invoice Discount:	0.00
				Total Sales Tax:	22.16
				Total:	261.58

Please remit payment to: ICONIX Waterworks (US) Inc.
PO BOX 1516
SNOHOMISH, WA 98291
USA

Interest is charged at 2% per month on all overdue amounts

DELIVERY TIMES AND PRICING FOR ALL GOODS AND SERVICES ORDERED HEREIN ARE SUBJECT TO CHANGE. PAYMENT TERMS FOR ALL GOODS AND SERVICES WILL BE NET 30 DAYS FROM THE INVOICE DATE. INTEREST IS CHARGED AT 2% ON ALL OVERDUE AMOUNTS. ANY GOODS OR SERVICES PROVIDED BY ICONIX WILL BE SUBJECT TO A LIMITED WARRANTY PROVIDED THAT WHERE ICONIX IS NOT THE MANUFACTURER OF GOODS. CUSTOMER'S SOLE RECOURSE FOR DEFECTIVE GOODS WILL BE TO THE MANUFACTURER'S EXPRESS WARRANTY, IF ANY. EXCEPT AS OTHERWISE SET OUT HEREIN. ALL GOODS AND SERVICES DESCRIBED HEREIN WILL BE PROVIDED SUBJECT TO ICONIX'S TERMS AND CONDITIONS WHICH SHALL SUPERSEDE AND TAKE PRECEDENCE OVER ANY OTHER TERMS AND CONDITIONS. THE ICONIX SALE TERMS AND CONDITIONS ARE AVAILABLE ON REQUEST OR ONLINE AT WWW.ICONIXWW.COM/UNITED-STATES/TERMS-AND-CONDITIONS-OF-SALE/

ICONIX Waterworks (US) Inc.

1359 DAYTON ST BLDG A
Salinas, CA 93901-4404
USA
Tel: 831-757-7776
Fax: 831-757-7832
www.iconixww.com

SALES SHIPMENT
COPY



Shipment Number: U2414005646
Shipment Date: 02/13/24
Page: 1

Bill To: ANDERSON PACIFIC
1370 NORMAN AVENUE
SANTA CLARA, CA 95054
USA
Tel: 408-970-9900

Ship To: ICONIX Waterworks (US) Inc.
1359 DAYTON ST BLDG A
SALINAS, CA 93901-4404
USA

Customer ID	ANDPAC	SalesPerson	Pete Rodriguez	P.O. Date	02/13/24
Ship Via	Customer Pickup	Sales Tel No.	831-737-5398	P.O. Number	2202
Ordered By	DANIEL	Inside Sales	Martin Diaz	Our Order No.	U2412005980
Shipping Payment Type	Freight Collect	Creator	SALNSPOS2	Cust Job No.	BOULDER CREEK
Ship. Agent Svc	WILLCALL	Posted By	SALNSPOS2	Job Desc	
Bill of Lading No.					

Item No.	Customer Item	Description	Unit	Ship Weight	Ordered	Shipped	Back Ordered
PP10CTS09100250		1 PE 4710 BLACK CTS SDR 9 100' 250 PSI	FOOT	17.00	100	100	
WWKV43444WGNL		1 FORD GJ CTS X MTR AMS NL	EACH	4.29	2	2	

Ship Weight: 21.29 (Pounds) 9.70 (KGs)

RECEIVED BY: _____
(PRINT NAME)

(SIGN HERE)

DATE: _____

DELIVERY TIMES AND PRICING FOR ALL GOODS AND SERVICES ORDERED HEREIN ARE SUBJECT TO CHANGE. PAYMENT TERMS FOR ALL GOODS AND SERVICES WILL BE NET 30 DAYS FROM THE INVOICE DATE. INTEREST IS CHARGED AT 2% ON ALL OVERDUE AMOUNTS. ANY GOODS OR SERVICES PROVIDED BY ICONIX WILL BE SUBJECT TO A LIMITED WARRANTY PROVIDED THAT WHERE ICONIX IS NOT THE MANUFACTURER OF GOODS, CUSTOMER'S SOLE RECOURSE FOR DEFECTIVE GOODS WILL BE TO THE MANUFACTURER'S EXPRESS WARRANTY, IF ANY. EXCEPT AS OTHERWISE SET OUT HEREIN, ALL GOODS AND SERVICES DESCRIBED HEREIN WILL BE PROVIDED SUBJECT TO ICONIX'S TERMS AND CONDITIONS WHICH SHALL SUPERSEDE AND TAKE PRECEDENCE OVER ANY OTHER TERMS AND CONDITIONS. THE ICONIX SALE TERMS AND CONDITIONS ARE AVAILABLE ON REQUEST OR ONLINE AT [WWW.ICONIXWWW.COM/UNITED-STATES/TERMS-AND-CONDITIONS-OF-SALE/](http://www.iconixww.com/UNITED-STATES/TERMS-AND-CONDITIONS-OF-SALE/)

2202

FERGUSON
WATERWORKS
66 TARP CIRCLE
SALINAS, CA 93901-3717

INVOICE NUMBER	TOTAL DUE	CUSTOMER	PAGE
1841461	\$157.79	450404	1 of 1

**PLEASE REFER TO INVOICE NUMBER WHEN
MAKING PAYMENT AND REMIT TO:**

Please contact with Questions: 916-381-6100

FERGUSON WATERWORKS #1423
PO BOX 740827
LOS ANGELES, CA 90074-0827

MASTER ACCOUNT NUMBER: 165276

RECEIVED
FEB 15 2024
APEC

SHIP TO:

ANDERSON PACIFIC ENG CONST INC
1390 NORMAN AVENUE
BOULDER CREEK WWTP JON NO
SANTA CLARA, CA 95054

COUNTER PICK UP
66 TARP CIRCLE
SALINAS, CA 93901-3717

SHIP WHSE.	SELL WHSE.	TAX CODE	CUSTOMER ORDER NUMBER	SALESMAN	JOB NAME	INVOICE DATE	BATCH
3306	3306	CA27SL	2202	KXC	BOULDER CREEK WWTP JON NO	02/13/24	IO 92160
ORDERED	SHIPPED	ITEM NUMBER	DESCRIPTION		UNIT PRICE	UM	AMOUNT
4	4	FC8444GNL	LF 1 MIP X 1 CTS GRIP COMP C		36.108	EA	144.43
INVOICE SUB-TOTAL							144.43
TAX Monterey/Salinas							13.38
ITEM CODE	DESCRIPTION		NOTICE				
FC8444GNL	LF 1 MIP X 1 CTS GRIP COMP C		<!-- WARNING: Cancer and Reproductive Harm WWW.P65WARNINGS.CA.GOV				
<p>LEAD LAW WARNING: IT IS ILLEGAL TO INSTALL PRODUCTS THAT ARE NOT "LEAD FREE" IN ACCORDANCE WITH US FEDERAL OR OTHER APPLICABLE LAW IN POTABLE WATER SYSTEMS ANTICIPATED FOR HUMAN CONSUMPTION. PRODUCTS WITH "NP" IN THE DESCRIPTION ARE NOT LEAD FREE AND CAN ONLY BE INSTALLED IN NON-POTABLE APPLICATIONS. BUYER IS SOLELY RESPONSIBLE FOR PRODUCT SELECTION.</p> <p>WATER FLOW RATE NOTICE: LAVATORY FAUCETS WITH FLOW RATES OVER 0.5 GPM ARE NOT ALLOWED FOR 'PUBLIC USE' IN CALIFORNIA.</p>							
<p>Looking for a more convenient way to pay your bill?</p> <p>Log in to Ferguson.com and request access to Online Bill Pay.</p> 							

TERMS: NET 10TH PROX	ORIGINAL INVOICE	TOTAL DUE	\$157.79
-----------------------------	-------------------------	------------------	-----------------

All past due amounts are subject to a service charge of 1.5% per month, or the maximum allowed by law, if lower. If Buyer fails to pay within terms, then in addition to other remedies, Buyer agrees to pay Seller all costs of collection, including reasonable attorney fees. Complete terms and conditions are available upon request or at <https://www.ferguson.com/content/website-info/terms-of-sale>, incorporated by reference. Seller may convert checks to ACH.



FERGUSON WATERWORKS #3305
66 TARP CIRCLE
SALINAS, CA 93901-3717

195

ORDER NO. 1841461
REQUIRED DATE 02/13/24
SHIP WHS. 3305
SELL WHS. 3305

PH: 831-424-3330 FAX: 831-424-3381

CUSTOMER NO. 450404
CUSTOMER ALPHA ANDERSONP
CONTRACT NO.

BID NO.

ORDER DATE 02/13/24
ORDERED BY DANIEL

ANDERSON PACIFIC ENG CONST INC
1390 NORMAN AVENUE
BOULDER CREEK UNIT JON NO
D SANTA CLARA, CA 95054

COUNTER PICK UP
66 TARP CIRCLE
SALINAS, CA 93901-3717

INSTRUCTIONS

SHIP VIA CPU COUNTER PICK-UP

PCS BAGS BOXES CRATES LENGTHS BUNDLES
SHIP WT. SHIP DATE DELIVERED BY CPU

CUSTOMER PO. NO. 2202
JOB NAME BOULDER CREEK UNIT JON NO
ATTN:

PACKED BY
CHECKED BY
AISLE LOC

LINE	ORDER QTY	SHIP QTY	ITEM CODE	DESCRIPTION	UNIT PRICE	U/M	TOTAL
1				LF 1 HIP X 1 CTS GRIP COMP C			0.9 lb

ITEM CODE	DESCRIPTION	UNIT PRICE	U/M	TOTAL	LESS DEPOSIT	TAX	OUTBOUND SHIPPING	INBOUND FREIGHT	SUBTOTAL	TOTAL DUE
FCB**00ML	LF 1 HIP X 1 CTS GRIP COMP C									
	NOTICE									
	WARNING: Cancer and Reproductive Toxicity http://www.p53warnings.ca.gov									
	AD CAN WARNING: It is illegal to install products that are not "lead free" in accordance with US Federal or other applicable law in potable water systems anticipated for human consumption. Products with NSF in the description are not lead free and can only be installed in non-potable applications. Buyer is solely responsible for product selection.									
	AFTER FLOW RATE NOTICE: Lavatory Faucets with flow rates over 0.5 GPM are not allowed per public use in California.									

NO RETURNS ALLOWED WITHOUT PROPER AUTHORIZATION. RETURNED MATERIALS SUBJECT TO HANDLING CHARGES.
SEE REVERSE SIDE FOR IMPORTANT TERMS AND CONDITIONS OF SALE AND LIMITATIONS OF WARRANTY.

Agenda: 4.4.24
Item: 10c

CUSTOMER'S SIGNATURE: Daniel

DATE: Feb 13/24

TERMS: CUSTOMER COPY

Work Performed by: **ANDERSON PACIFIC ENGINEERING CONSTRUCTION, INC.**
Work Performed at the direction of: **San Lorenzo Valley Water District**

Description of Work: Layout, excavate, saddle and tap 121/126 Moonridge Dri.; install new service lines and meter boxes.

EQUIP. NO.	EQUIPMENT	OT/Delay Factor	HOURS		HOURLY RATE	EXTENDED AMOUNTS	LABOR	HOURS		HOURLY RATE	EXTENDED AMOUNTS
			RT	OT				RT	OT		
1018	FORD F150 PICKUP TRUCK	1	8		\$ 37.61	\$ 300.88	FOREMAN	8		\$ 105.82	\$ 846.56
							J. Swain				
1020	FORD F250 CREW TRUCK - UTILITY	1	8		\$ 42.39	\$ 339.12	OPERATOR 3	8		\$ 99.79	\$ 798.32
							T. Thurman				
7009	FORD F650 BOBTAIL DUMP TRUCK - 5 CY	1	8		\$ 73.34	\$ 586.72	CONSTRUCTION SPECIALIST	8		\$ 71.93	\$ 575.44
							J. Gomez				
3022	KOBELCO SK 45SRX-6E	1	8		\$ 48.03	\$ 384.24	LAB APP 3	8		\$ 63.32	\$ 506.56
							D. Lizaola-Ramos				
1005	CHEVY 3500HD CREW TRUCK - PAVING	1	8		\$ 42.39	\$ 339.12	LABORER 1	8		\$ 71.15	\$ 569.20
							A. Flores				
0		1			\$ -	\$ -	LABORER 1	8		\$ 71.15	\$ 569.20
							V. Espino				
0		1			\$ -	\$ -	LABORER 1	8		\$ 71.15	\$ 569.20
							J. Ramos				
0		1			\$ -	\$ -	LABORER 1	8		\$ 71.15	\$ 569.20
							Chance Guidotti				
0		1			\$ -	\$ -				\$ -	\$ -
										\$ -	\$ -
0		1			\$ -	\$ -				\$ -	\$ -
										\$ -	\$ -
0		1			\$ -	\$ -				\$ -	\$ -
										\$ -	\$ -
MATERIAL and/or TRUCKING											
Description		No. Units			Unit Cost	Amount					
Material	Scarborough- 420252/2	1.00	LS		\$26.23	\$26.23	Sub-Total Labor RT		INCLUDED		\$ 5,003.68
		1.00	LS			\$0.00	Labor Surcharge RT				\$ -
		1.00	LS			\$0.00	Sub-Total Labor OT		INCLUDED		\$ -
		1.00	LS			\$0.00	Labor Surcharge OT				\$ -
		1.00	LS			\$0.00	Subsistence				\$ -
WORK DONE BY SUBCONTRACTOR and/or SPECIALISTS											
Description		No. Units			Unit Cost	Amount					
		1.00	LS			\$0.00					\$ 5,003.68
		1.00	LS			\$0.00					\$ 1,976.31
		1.00	LS			\$0.00					\$ -
TOTAL COST OF EQUIPMENT, MATERIALS AND TRUCKING											\$ 5,003.68
TOTAL COST OF SUBCONTRACTOR AND SPECIALISTS											\$ 1,976.31
13% MARK-UP ON LABOR COST											\$ -
10% MARK-UP ON EQUIPMENT, MATERIALS AND TRUCKING COST											\$ 650.48
7% MARK-UP ON SUBCONTRACTOR AND SPECIALISTS COST											\$ 197.63
TOTAL THIS REPORT											\$ 7,828.10

SCARBOROUGH HOME CENTER, INC.
9470 HIGHWAY 9, BEN LOMOND 95005
MAIL: P.O. BOX 66599
SCOTT VALLEY, CA 95067
PHONE: (831) 336-5142

30 DAYS** + RECEIPT REQUIRED ON
 ALL RETURNS / EXCHANGES

9909

Customer No. 12617	Job No. 2202	Purchase Order No. 2202	Reference WATERLINE	Terms 1% 10TH, NET 11TH,	Clerk JEM	Date 2/15/24	Time 8:10
-----------------------	-----------------	----------------------------	------------------------	-----------------------------	--------------	-----------------	--------------

Sold To
 * ANDERSON PACIFIC ENGINEERING
 1370 NORMAN AVE.
 SANTA CLARA, CA 95054
 (408) 970-9900

Ship To

DOC# 420252/2

 * INVOICE *

 SLSPR: 00 DEFAULT
 TAX : 200 SALES TAX: S CRUZ COU
 TERM#566

SHIPPED	ORDERED	UM	SKU	DESCRIPTION	UNITS	PRICE/PER	EXTENSION
4		EA	47804	SQUARE PLUG GLV 3/4"	4	3.99 /EA	15.96
2		EA	47803	SQU PLUGS GVL 1/2"MIP	2	2.99 /EA	5.98
1		EA	47795	CAPS GLV 1"	1	4.79 /EA	4.79

62	** AMOUNT CHARGED TO STORE ACCOUNT **	26.23	TAXABLE	26.73
	(GOMEZ, JOSE)		NON-TAXABLE	0.00
			SUBTOTAL	26.73
			TD DISCOUNT	-2.67
			TAX AMOUNT	2.17
			TOTAL AMOUNT	26.23

José Gomez

X _____
 Received By

Description of Work: Set new meter boxes, remove existing meters; shallow bury service line; backfill excavation with slurry, collars around meter boxes.

EQUIP. NO.	EQUIPMENT	OT/Delay Factor	HOURS		HOURLY RATE	EXTENDED AMOUNTS	LABOR	HOURS		HOURLY RATE	EXTENDED AMOUNTS
			RT	OT				RT	OT		
1018	FORD F150 PICKUP TRUCK	1	6		\$ 37.61	\$ 225.66	FOREMAN	6		\$ 105.82	\$ 634.92
							J. Swain				
1020	FORD F250 CREW TRUCK - UTILITY	1	8		\$ 42.39	\$ 339.12	OPERATOR 3	8		\$ 99.79	\$ 798.32
							T. Thurman				
1026	FORD F250 CREW TRUCK - UTILITY	1	8		\$ 42.39	\$ 339.12	CONSTRUCTION SPECIALIST	8		\$ 71.93	\$ 575.44
							J. Gomez				
3022	KOBELCO SK 45SRX-6E	1	8		\$ 48.03	\$ 384.24	LAB APP 3	8		\$ 63.32	\$ 506.56
							D. Lizaola Ramos				
0		1	8				LABORER 1	8		\$ 71.15	\$ 569.20
							A. Flores				
0		1	8				LABORER 1	8		\$ 71.15	\$ 569.20
							Chance Guidotti				
0		1	8				LABORER 1	8		\$ 71.15	\$ 569.20
							M. Cabral				
0		1	8				LABORER 1	8		\$ 71.15	\$ 569.20
							G. Musante				
0		1	8				0	8			
							0				
0		1	8				0	8			
							0				
0		1	8				0	8			
							0				
MATERIAL and/or TRUCKING											
Description		No. Units			Unit Cost	Amount					
Material	Las Animas- 379564- 4 yds	1.00	LS		\$644.42	\$644.42	Sub-Total Labor RT		INCLUDED		\$ 4,792.04
Material	Core & Main- U373133	1.00	LS		\$866.39	\$866.39	Labor Surcharge RT				
		1.00	LS		\$0.00	\$0.00	Sub-Total Labor OT		INCLUDED		
		1.00	LS		\$0.00	\$0.00	Labor Surcharge OT				
		1.00	LS		\$0.00	\$0.00	Subsistence				
WORK DONE BY SUBCONTRACTOR and/or SPECIALISTS											
Description		No. Units			Unit Cost	Amount					
		1.00	LS			\$0.00					
		1.00	LS			\$0.00					
		1.00	LS			\$0.00					
TOTAL COST OF EQUIPMENT, MATERIALS AND TRUCKING											\$ 4,792.04
TOTAL COST OF SUBCONTRACTOR AND SPECIALISTS											\$ 2,798.95
13% MARK-UP ON LABOR COST											\$ -
10% MARK-UP ON EQUIPMENT, MATERIALS AND TRUCKING COST											\$ 622.97
7% MARK-UP ON SUBCONTRACTOR AND SPECIALISTS COST											\$ 279.90
TOTAL THIS REPORT											\$ 8,493.85



BILLING INFORMATION

NAME: ANDERSON PACIFIC
ADDRESS: 1570 NORMAN AVE
CITY/STATE/ZIP: SANTA CLARA, CA
PHONE: 408-970-9900

DAILY EXTRA WORK REPORT

DATE PERFORMED: 2/16/2024

WORK PERFORMED AT THE DIRECTION OF: SAN LORENZO WATER DISTRICT

DESCRIPTION OF WORK: SET NEW METER BOXES - REMOVE EXISTING METERS

CONTRACTOR JOB NO: 2202

CONTRACTOR REPORT NO:

SHALLOW BURY SERVICE LINE - BACKFILL SURFACE EXCAVATION - POUR COLLARS AROUND METER BOXES

EQUIP NO	EQUIPMENT	HOURS	HOURLY/DAILY RATE	EXTENDED AMOUNTS	P.R. NO.	LABOR	HOURS		HOURLY RATE	EXTENDED AMOUNTS
							REG	OT		
1014	FORD F150	6			F	JOE SWAIN	6			
1020	LOWERY TRUCK	8								
1026	UTILITY TRUCK	8			03	TOMMY THURMAN	8			
302	MINI EX	8			05	JOSE GOMEZ	8			
						LI ANA FLORES	8			
						LI CHARLE BURTON	8			
						LA3 DANIEL RAMOS	8			
						LI MARIL CABROL	8			
						LI GEORGE MANSUNTE	8			

MATERIAL AND/OR WORK DONE BY SPECIALISTS

DESCRIPTION	NO. UNIT	UNIT COST	EXTENDED	SUB-TOTAL
LAC ANTIWAX 379564	4 YDS			
SCAFFOLD 679024				
CARDS & MTR - 437313				
TOTAL COST OF EQUIPMENT, MATERIALS AND WORK				
TOTAL COST OF LABOR				A
TOTAL A & B				B

ACCEPTED:

CONTRACTOR'S REPRESENTATIVE

OWNER/AGENT

MARKUP ON EQUIPMENT, MATERIAL AND WORK COST: _____ %

TOTAL THIS REPORT

LAS ANIMAS CONCRETE
 P.O. BOX 507
 Santa Cruz, CA 95061
 831/426-7280

Sales Invoice 188211

Invoice Date: 02/16/2024

Due Date: 03/17/2024

Printed Date: 02/20/2024

Page: 1

Bill To:

Anderson Pacific
 Attention: Accounts Payable
 1370 Norman Avenue
 Santa Clara, CA 95054

Ship To:

HEAD UP PROSPECT

RECEIVED

FEB 22 2024

APEC

Customer ID	Purchase Order	Terms	Ship Via	F.O.B.	Sales Person	Ship From	Source
AND2	HEAD UP PROSPECT	1% 15 Net 30			CN	WHSE	

Order Qty	U.O.M.	Description	Unit Price	Tax	Extended Price
8.00	YD	2.00 SK SAND SLURRY 379564	122.00000	Y	976.00
8.00	YD	Freight Chg - Bonny Doon, BC town 379564	20.00000	N	160.00
10.00	EA	Standby Time	1.50000	N	15.00
1.00	YD	AB219	50.00000	N	50.00

1298.84 / 2 = 649.42
4yds 9909

Non Taxable Subtotal	225.00
Taxable Subtotal	976.00
Order Discount	0.00
Shipping/Handling	0.00
Tax	87.84
Order Total	1,288.84

IMPORTANT: SEE REVERSE FOR INFORMATION REGARDING MECHANICS LIEN LAWS, CREDIT SALE INFORMATION, & TERMS AND CONDITIONS OF SALE

SOLD BY Las Animas Concrete & Building Supply, Inc.

Mailing Address: PO Box 507
Santa Cruz, CA 95061

Business Address:
146 ENCINAL STREET
SANTA CRUZ, CA 95060
831/426-7280

CAUTION: Freshly mixed concrete may cause skin irritation on prolonged exposure. Avoid direct contact where possible and wash exposed skin areas promptly with water. If any cementitious materials get into the eye, rinse immediately and repeatedly with water and get prompt medical attention. Keep out of reach of children.

SOLD TO: _____ SHIP TO: _____

4475 9909

TIME	MIX NO.	CU. YDS./METERS THIS LOAD	YDS./METERS ORD'D	USE	DRIVER/TRUCK	MAP COORDINATE	PLANT/TRANSACTION #
DATE	NO. OF LOADS	ACCUM. YDS./METERS	BATCH #	WATER TRIM	SLUMP	TICKET NUMBER	

NOTICE: MY SIGNATURE BELOW INDICATES THAT I HAVE READ THE HEALTH WARNING NOTICE AND SUPPLIER WILL NOT BE RESPONSIBLE FOR ANY DAMAGE CAUSED WHEN DELIVERING INSIDE CURB LINE.

WEIGHMASTER CERTIFICATE: THIS IS TO CERTIFY that the following described commodity was weighed, measured or counted by a weighmaster, whose signature is on this certificate, who is a recognized authority of accuracy, as prescribed by Chapter 7 (commencing with Section 12100) of Division 5 of the California Business and Professions Code, administered by the Division of Measurement Standards of the California Department of Food and Agriculture

LAS ANIMAS CONCRETE & BUILDING SUPPLY, INC. AND DRIVER OF TRUCK are released from all responsibility of addition to colors due to variations in cement and aggregate materials or admixtures, and for damages which may be incurred in delivering materials across the curb or property line. Claims will not be allowed unless made at the time this material was delivered. ADDITIONAL WATER ADDED TO THIS CONCRETE WILL REDUCE ITS STRENGTH. ANY WATER ADDED IS AT CUSTOMER'S OWN RISK.

JOB SITE CYLINDER TEST: YES NO
 Water Added _____ Gals to full load YES
 On Job At _____ Gals to 2/3 load YES
 Customer's Request _____ Gals to 1/3 load YES

LAS ANIMAS CONCRETE & BUILDING SUPPLY, INC. WEIGHMASTER
 WEIGHED AT * _____
 BY: _____ DEPUTY

CONCRETE IS A PERISHABLE COMMODITY AND BECOMES THE PROPERTY OF THE PURCHASER UPON LEAVING THE PLANT. ANY CHANGES OR CANCELLATION OF ORIGINAL INSTRUCTIONS MUST BE TELEPHONED TO OFFICE BEFORE LOADING STARTS

RECEIVED BY: X _____

AUTHORIZED BY: X _____

QUANTITY	CODE	DESCRIPTION	PRICE CU. YD./METER	EXTENDED PRICE

LEAVE PLANT	ARRIVE JOB	START UNLOAD	FINISH UNLOAD	ARRIVE PLANT	TOTAL TIME

SUB TOTAL _____
 TAX TOTAL _____
 TOTAL _____

ADDITIONAL CHARGE 1. _____
 ADDITIONAL CHARGE 2. _____
GRAND TOTAL ▶ _____

BATCH DATA

Plant	Batch	Order	Plant	Plant	Plant	Plant	Plant

CONTROL NO. **379562**

Material	Spec. Qty	Required	Delivered	Over	% Moisture	Actual Wet
CEMENT	1500 lb	1500 lb	1500 lb	-0.00		
WATER	32 gal	32 gal	32 gal	0.00		
AD MIXTURE	100.00 lb	100.00 lb	100.00 lb	0.00		
AD MIXTURE	100.00 lb	100.00 lb	100.00 lb	0.00		

Actual Total: 1500 lb Cement, 32 gal Water, 100.00 lb Admixture, 100.00 lb Admixture = 1632.00 lb
 Total: 1632.00 lb
 Actual Water: 32.00 gal
 Total Water: 32.00 gal
 Actual Cement: 1500.00 lb
 Total Cement: 1500.00 lb



INVOICE

1830 Craig Park Court
St. Louis, MO 63146

Invoice # U373133
Invoice Date 2/14/24
Account # 209395
Sales Rep ROBERT BARTHOLOMEW
Phone # 831-663-3741
Branch #285 Salinas, CA
Total Amount Due \$866.39

Remit To:
CORE & MAIN LP
PO BOX 28330
ST LOUIS, MO 63146

ANDERSON PACIFIC ENGINEERING 000/0000
1370 NORMAN AVE 00000
SANTA CLARA CA 95054-2056

Shipped To:
CUSTOMER PICK-UP

CUSTOMER JOB- SCOTTSV SCOTTS VALLEY O 2202

Thank you for the opportunity to serve you! We appreciate your prompt payment.

Date Ordered	Date Shipped	Customer PO #	Job Name	Job #	Bill of Lading	Shipped Via	Invoice#
2/12/24	2/13/24	2202	SCOTTS VALLEY O	SCOTTSV		WILL CALL	U373133

Product Code	Description	Quantity		B/O	Price	UM	Extended Price
		Ordered	Shipped				
71BR2B0899IP100	BR2B0899IP100 SAD 8X1IP 8.99-9.67 DBL STRAP BRNZ SAD	2	2		171.75000	EA	343.50
▲ L	*** CA Prop 65 - see below ***						
361074704B22	74704B-22 1 BALL CORP STOP NL MIPXCTS NO LEAD	2	2		82.79000	EA	165.58
▲ L	*** CA Prop 65 - see below ***						
0910E250C1	1X100 CTS PE TUBING 250PSI PE 4710 NSF SDR-9 D2737 BLACK	500	500		.59000	FT	295.00

RECEIVED
FEB 15 2024
APEC

2202

Freight Delivery Handling Restock Misc

Subtotal: 804.08
Other: .00
Tax: 62.31
Invoice Total: \$866.39

Terms: 24 30 DAYS If paid by 3/15, deduct \$16.08
Ordered By: DANIEL

This transaction is governed by and subject to Core & Main's standard terms and conditions, which are incorporated by reference and accepted.
To review these terms and conditions, please visit: <http://tandc.coreandmain.com/>



Local Knowledge
Local Experience
Local Service, Nationwide*

PROMISED: 2/12/24
FILLED BY: TC

CHECKED BY:

REVIEWED BY:

ENTERED BY: TYCHE CARVEIRO - 285

SPECIAL INSTRUCTIONS/COMMENTS:

9909

PICK TICKET U373133

CUSTOMER PICKUP

ANDERSON PACIFIC ENGINEERING
Branch - 285
831 El Camino Real North
Salinas CA 93907

SALINAS CA
Branch - 285
831 El Camino Real North
Salinas CA 93907
PHONE # 831 663 3741

209395 02/12/2024 04 08 PM PAGE 1

ANDERSON PACIFIC ENGINEERING
STOCK - UNION CITY
1370 NORMAN AVE
SANTA CLARA CA 95054-2056
CUS PH# 408 970 9900

BRANCH NO	DATE ORDERED	DATE SHIPPED	PURCHASE ORDER NO	JOB NAME	DESCRIPTION	JOB NAME*	DELIVERY METHOD		BILL OF LADING NO	SHIPPED VIA	SALESMAN
							CUSTOMER TRUCK	SHIPPED			
285	2/12/24	2/12	2202	2202	DANIEL		QTY ORDERED	QTY SHIPPED	UNIT PRICE	PER	AMOUNT
W11 1 A	718R2B0899IP100				BR2B0899IP100 SAD 8X11P 8.99-9.67 DBL STRAP BRNZ SAD WEIGHT: 10.0700 LB *** CA PROP 65 - SEE BELOW ***		2	2		EA	
W17 1 A	361074704822				747048-22 1 BALL CORP STOP NL MIPXCTS NO LEAD WEIGHT: .0500 LB *** CA PROP 65 - SEE BELOW ***		2	2		EA	
Y09 1 A	0910E250C1				1X100 CTS PE TUBING 250PSI PE 4710 NSF SDR-9 D2737 BLACK WEIGHT: .2410 LB *REF 5.00 TOTAL WEIGHT: 140.74	RL	500	500		FT	
MERCHANDISE SUBTOTAL											CONTINUED
TAX AMOUNT											TOTAL SALE
FREIGHT											
DELIVERY											
HANDLING											
RESTOCKING											
MISCELLANEOUS											

RECEIVED BY SIGNATURE:
PRINT NAME HERE:



U373133209395

This transaction is governed by and subject to Core & Main's standard terms and conditions, which are incorporated by reference and accepted. To review these terms and conditions, please visit <http://tamdc.coreandmain.com/>.

*** CA PROP 65 SEE LAST PAGE ***

Description of Work: Service relocations @ 11623 Alta Via; dig up existing saddle; turn off corp stop and removal service line/ meter; dig up new location and install saddle and new meter box

EQUIP. NO.	EQUIPMENT	OT/Delay Factor	HOURS		HOURLY RATE	EXTENDED AMOUNTS	LABOR	HOURS		HOURLY RATE	EXTENDED AMOUNTS
			RT	OT				RT	OT		
1018	FORD F150 PICKUP TRUCK	1	8		\$ 37.61	\$ 300.88	FOREMAN	8		\$ 105.82	\$ 846.56
							J. Swain				
1020	FORD F250 CREW TRUCK - UTILITY	1	8		\$ 42.39	\$ 339.12	CONSTRUCTION SPECIALIST	8		\$ 71.93	\$ 575.44
							J. Gomez				
3022	KOBELCO SK 45SRX-6E	1	8		\$ 48.03	\$ 384.24	OPERATOR 3	8		\$ 99.79	\$ 798.32
							J. Ramos				
7006	FORD F650 BOBTAIL DUMP TRUCK - 5 CY	1	4		\$ 73.34	\$ 293.36	LAB APP 3			\$ 63.32	
							D. Lizaola Ramos				
0		1	8				LABORER 1	8		\$ 71.15	\$ 569.20
							T. Thurman				
0		1	4				LABORER 1	4		\$ 71.15	\$ 284.60
							Jesus Ramos				
0		1	4				TEAMSTER 1	4		\$ 76.50	\$ 306.00
							Jesus Ramos				
0		1	8				LABORER 1	8		\$ 71.15	\$ 569.20
							G. Musante				
0		1	8				LABORER 1	8		\$ 71.15	\$ 569.20
							A. Flores				
0		1	8				0				
0		1	8				0				
MATERIAL and/or TRUCKING											
Description		No. Units			Unit Cost	Amount					
Material	Scotts Valley Sprinkler (31763/9)	1.00	LS		\$115.07	\$115.07	Sub-Total Labor RT		INCLUDED		\$ 4,518.52
Material	Ferguson- 1842631	1.00	LS		\$301.86	\$301.86	Labor Surcharge RT				
		1.00	LS			\$0.00	Sub-Total Labor OT		INCLUDED		\$
		1.00	LS			\$0.00	Labor Surcharge OT				
		1.00	LS			\$0.00	Subsistence				
WORK DONE BY SUBCONTRACTOR and/or SPECIALISTS											
Description		No. Units			Unit Cost	Amount					
		1.00	LS			\$0.00					
		1.00	LS			\$0.00					
		1.00	LS			\$0.00					
TOTAL COST OF EQUIPMENT, MATERIALS AND TRUCKING											\$ 4,518.52
TOTAL COST OF SUBCONTRACTOR AND SPECIALISTS											\$ 1,734.53
13% MARK-UP ON LABOR COST											\$ 587.41
10% MARK-UP ON EQUIPMENT, MATERIALS AND TRUCKING COST											\$ 173.45
7% MARK-UP ON SUBCONTRACTOR AND SPECIALISTS COST											\$ -
TOTAL THIS REPORT											\$ 7,013.91

9909

ANDERSON PACIFIC

Engineering Construction, Inc.

BILLING INFORMATION:

NAME: ANDERSON PACIFIC
 ADDRESS: 1370 NORMAN AVE
 CITY/STATE/ZIP: SANTA CLARA, CA
 PHONE: 408.970.9900

206

DAILY EXTRA WORK REPORT

DATE PERFORMED 2/21/2024

WORK PERFORMED AT THE DIRECTION OF: SAN LORENZO WATER DISTRICT CONTRACTOR JOB NO. 2202

DESCRIPTION OF WORK: SERVICE RELOCATION @ 11623 ALTA VIA - DIG UP EXISTING CONTRACTOR REPORT NO. _____

SADDLE/TURN OFF COOLD STOP AND REMOVE SERVICE LINE/METER - DIG UP NEW LOCATION/INSTALL SADDLE+NEW METER+BOX

EQUIP NO.	EQUIPMENT	HOURS	HOURLY/DAILY RATE	EXTENDED AMOUNTS	P.R. NO.	LABOR	HOURS	HOURLY RATE	EXTENDED AMOUNTS
1018	FORD F-150	8			F	JOE SWAN	8		
1020	UTILITY TRUCK	8							
3022	MINI/EX	8			03	JOE RAMOS	8		
7006	BUSTALL	4			CS	JOSE GOMEZ	8		
					LI	TOMMY THURMAN	8		
					LI	JOSE RAMOS	4		
					LI	GEORGE MANSANTE	8		
					LI	ANA FLORES	8		
					TI	JESUS RAMOS	4		

MATERIAL AND/OR WORK DONE BY SPECIALISTS

DESCRIPTION	NO. UNIT	UNIT COST	EXTENDED
SV SPRINKLER 31763/9			
PERMAN 1842361			

TOTAL COST OF EQUIPMENT, MATERIALS AND WORK

TOTAL COST OF LABOR				A
PAYROLL BURDEN AND/OR MARKUPS				B
TOTAL A & B				
MARKUP ON EQUIPMENT, MATERIAL AND WORK COST _____%				
TOTAL THIS REPORT				

CONTRACTOR'S REPRESENTATIVE

OWNER/AGENT

SCOTTS VALLEY SPRINKLER
5010 SCOTTS VALLEY DR., SV, CA
MAIL: P.O. BOX 66837
SCOTTS VALLEY CA. 95067
PHONE: (831) 438-6450
 30 DAYS** + RECEIPT REQUIRED ON RETURNS
 RETURNS ARE SUBJECT TO A RESTOCKING FEE!

9909

CUST NO: 9435	JOB NO: 000	PURCHASE ORDER: 2202	REFERENCE: ALTA VIA WATER MAIN	TERMS: 2% 10TH, NET 11TH	CLERK: SBM	DATE / TIME: 2/21/24 2:47
-------------------------	-----------------------	--------------------------------	--	------------------------------------	----------------------	-------------------------------------

TERMINAL: 914

SOLD TO:
 ANDERSON PACIFIC ENG.
 1370 NORMAN AVENUE

 SANTA CLARA CA 95054-2047
 408-970-9900

SHIP TO:

TAX: S01 TAX: SCOTTS VALLEY SV

INVOICE: 31763 /9

LINE	SHIPPED	ORDERED	UM	SKU	DESCRIPTION	SUGG	UNITS	PRICE/ PER	EXTENSION
1	15	15	EA	6EB	6" ROUND VALVE BOX W/COVER 15/9		15	6.99 /EA	104.85 *

TAXABLE	104.85	SUBTOTAL	104.85
NON-TAXABLE	0.00		

(JOSE GOMEZ)	SUBTOTAL	104.85
** AMOUNT CHARGED TO STORE ACCOUNT **		
032	115.07	
	TAX AMOUNT	10.22
	TOTAL	115.07

TOT WT: 0.00

x Jose Gomez
 Received By

WJL

FERGUSON
WATERWORKS
 66 TARP CIRCLE
 SALINAS, CA 93901-3717

INVOICE NUMBER	TOTAL DUE	CUSTOMER	PAGE
1842631	\$301.86	454161	1 of 1

PLEASE REFER TO INVOICE NUMBER WHEN MAKING PAYMENT AND REMIT TO:

FERGUSON WATERWORKS #1423
 PO BOX 740827
 LOS ANGELES, CA 90074-0827

MASTER ACCOUNT NUMBER: 165276

SHIP TO:

RECEIVED
 Please contact with Questions 916-381-8100
FEB 22 2024
APEC

ANDERSON PACIFIC ENG CONST INC
 1390 NORMAN AVENUE
 ALTA VIA PIPELINE REPALCE
 SANTA CLARA, CA 95054

COUNTER PICK UP
 66 TARP CIRCLE
 SALINAS, CA 93901-3717

SHIP WHSE.	SELL WHSE.	TAX CODE	CUSTOMER ORDER NUMBER	SALESMAN	JOB NAME	INVOICE DATE	BATCH
3306	3306	CA27SL	2202	KXC	ALTA VIA PIPELINE REPALCE	02/20/24	ID 92250
ORDERED	SHIPPED	ITEM NUMBER	DESCRIPTION	UNIT PRICE	UM	AMOUNT	
1		FFB11004NL	LF 1 MIP X CTS PJ BALL CORP ST	129.404	EA	129.40	
2		FCB444GNL	LF 1 MIP X 1 CTS GRIP COMP C	21.600	EA	43.20	
4		FINSERT52	1 CTS PET / HDPE DR9 INS STFNR	1.840	EA	7.36	
2		PSDTU260S	2X60 DUCT TAPE UTIL GRD SILV	8.800	EA	17.60	
1		EUI50FS	5 GAL TYPE I MTL SAF GAS CAN W/ FUN	78.740	EA	78.74	
INVOICE SUB-TOTAL						276.30	
TAX						Monterey/Salinas	25.56
ITEM CODE		DESCRIPTION	NOTICE				
FFB11004NL		LF 1 MIP X CTS PJ BALL CORP ST	<!-- WARNING: Cancer and Reproductive Harm www.P65Warnings.ca.gov				
FCB444GNL		LF 1 MIP X 1 CTS GRIP COMP C	<!-- WARNING: Cancer and Reproductive Harm www.P65Warnings.ca.gov				
FINSERT52		1 CTS PET / HDPE DR9 INS STFNR	<!-- WARNING: Cancer and Reproductive Harm www.P65Warnings.ca.gov				
EUI50FS		5 GAL TYPE I MTL SAF GAS CAN W/ FUN	<!-- WARNING: Cancer and Reproductive Harm www.P65Warnings.ca.gov				
LEAD LAW WARNING: IT IS ILLEGAL TO INSTALL PRODUCTS THAT ARE NOT "LEAD FREE" IN ACCORDANCE WITH US FEDERAL OR OTHER APPLICABLE LAW IN POTABLE WATER SYSTEMS ANTICIPATED FOR HUMAN CONSUMPTION. PRODUCTS WITH "NP" IN THE DESCRIPTION ARE NOT LEAD FREE AND CAN ONLY BE INSTALLED IN NON-POTABLE APPLICATIONS. BUYER IS SOLELY RESPONSIBLE FOR PRODUCT SELECTION.							
WATER FLOW RATE NOTICE: LAVATORY FAUCETS WITH FLOW RATES OVER 0.5 GPM ARE NOT ALLOWED FOR PUBLIC USE IN CALIFORNIA.							

Looking for a more convenient way to pay your bill?

Log in to [Ferguson.com](https://www.ferguson.com) and request access to Online Bill Pay.



TERMS: NET 10TH PROX	ORIGINAL INVOICE	TOTAL DUE	\$301.86
-----------------------------	-------------------------	------------------	-----------------

All past due amounts are subject to a service charge of 1.5% per month, or the maximum allowed by law, if lower. If Buyer fails to pay within terms, then in addition to other remedies, Buyer agrees to pay Seller all costs of collection, including reasonable attorney fees. Complete terms and conditions are available upon request or at <https://www.ferguson.com/content/website-info/terms-of-sale>, incorporated by reference. Seller may convert checks to ACH.



FERGUSON WATERWORKS 33306
 66 TARP CIRCLE
 SALINAS, CA 93901-3717

209

ORDER NO. 1842631
 REQUIRED DATE 02/20/24
 SHIP WHS 3306
 SELL WHS 3306

STOCK SALES ORDER

9909

ACCEPT 8/0 = N
 SHOWROOM = N
 SOURCE = SOE
 IB FRT = N
 OK SHP = N
 20 FEB 2024 14:24:00

WRITER SD
 SALESMAN KXC/JPL

CUSTOMER NO. 454161
 CUSTOMER ALPHA ANDERSONP
 CONTRACT NO.
 BID NO.
 ORDER DATE 02/20/24
 ORDERED BY JOSE

INSTRUCTIONS

OML CONTACT Steven Drew
 VENDOR

ANDERSON PACIFIC ENG CONST INC
 1290 MORMAN AVENUE
 ALTA VIA PIPELINE REPALCE
 SANTA CLARA, CA 95054

COUNTER PICK UP
 66 TARP CIRCLE
 SALINAS, CA 93901-3717

SHIP VIA CPU COUNTER PICK-UP

ROUTE NO. RUN NO. DEPART TIME

ROUTE DESC. CHECKED BY

CUSTOMER PO. NO. 2202
 JOB NAME ALTA VIA PIPELINE REPALCE
 ATTN:

PACKED BY

aisle LOC

LINE	ORDER QTY.	SHIP QTY.	ITEM CODE	DESCRIPTION	UNIT PRICE	U/M	TOTAL	DELIVERED BY	PO. NO.	aisle LOC
1	1	1	0 FFB1000ML	LF 1 HIP X CTS PJ BALL CORP ST		EA			2-9 1B	110-12-03
2	2	2	0 FCB4400ML	LF 1 HIP X 1 CTS GRIP COMP C		EA			0-9 1B	110-14-03
3	4	4	0 FINSERT52	1 CTS PET / HDPE DRG INS STEHR		EA			0-1 1B	110-04-02
4	2	2	0 FSDT0260S	2X80 DUCT TAPE UTIL GRD SILV		EA			1-2 1B	110-02-01
5	1	1	0 EUIS0FS	5 GAL TYPE 1 MIL SAF GAS CAN W/ FUN		EA			0-9 1B	102-14-01
				NOTICE						102-14-01
				LF 1 HIP X CTS PJ BALL CORP ST						102-14-01
				LF 1 HIP X CTS GRIP COMP C						102-14-01
				1 CTS PET / HDPE DRG INS STEHR						102-14-01
				5 GAL TYPE 1 MIL SAF GAS CAN W/ FUN						102-14-01

NO RETURNS ALLOWED WITHOUT PROPER AUTHORIZATION. RETURNED MATERIALS SUBJECT TO HANDLING CHARGES.
 SEE REVERSE SIDE FOR IMPORTANT TERMS AND CONDITIONS OF SALE AND LIMITATIONS OF WARRANTY.

SUBTOTAL	INBOUND FREIGHT	OUTBOUND SHIPPING	TAX	LESS DEPOSIT	TOTAL DUE

CUSTOMER'S SIGNATURE: Jose Gomez
 DATE:
 TERMS: CUSTOMER COPY
 CONTINUED*

Set valve boxes next to meter boxes for new services on Monan Drive; pour slurry @11623 and meter box collars

Description of Work:

EQUIP. NO.	EQUIPMENT	OT/Delay Factor	HOURS		HOURLY RATE	EXTENDED AMOUNTS	LABOR		HOURS	HOURLY RATE	EXTENDED AMOUNTS
			RT	OT			RT	OT			
1018	FORD F150 PICKUP TRUCK	1	8		\$ 37.61	\$ 300.88	FOREMAN	8	\$ 105.82	\$ 846.56	
							J. Swain	OT			
1020	FORD F250 CREW TRUCK - UTILITY	1	8		\$ 42.39	\$ 339.12	OPERATOR 3	2	\$ 99.79	\$ 199.58	
							T. Thurman	OT			
1026	FORD F250 CREW TRUCK - UTILITY	1	8		\$ 42.39	\$ 339.12	LABORER 1	6	\$ 71.15	\$ 426.90	
							T. Thurman	OT			
3022	KOBELCO SK 45SRX-6E	1	2		\$ 48.03	\$ 96.06	LAB APP 3	RT	\$ 63.32	\$ -	
							D. Lizola Ramos	OT			
7006	FORD F650 BOBTAIL DUMP TRUCK - 5 CY	1	2		\$ 73.34	\$ 146.68	LABORER 1	8	\$ 71.15	\$ 569.20	
							A. Flores	OT			
0		1	RT				LABORER 1	8	\$ 71.15	\$ 569.20	
							Jesus Ramos	OT			
0		1	RT				CONSTRUCTION SPECIA	8	\$ 71.93	\$ 575.44	
							J. Gomez	OT			
0		1	RT				0	RT			
							0	OT			
0		1	RT				0	RT			
							0	OT			
0		1	RT				0	RT			
							0	OT			
0		1	RT				0	RT			
							0	OT			
MATERIAL and/or TRUCKING											
Description	No. Units	Unit Cost	Amount								
Material Las Animas- 379637	1.00 LS	\$1,001.72	\$1,001.72								
	1.00 LS	\$0.00	\$0.00								
	1.00 LS	\$0.00	\$0.00								
	1.00 LS	\$0.00	\$0.00								
	1.00 LS	\$0.00	\$0.00								
WORK DONE BY SUBCONTRACTOR and/or SPECIALISTS											
Description	No. Units	Unit Cost	Amount								
	1.00 LS	\$0.00	\$0.00								
	1.00 LS	\$0.00	\$0.00								
	1.00 LS	\$0.00	\$0.00								
TOTAL COST OF LABOR											
										Sub-Total Labor RT	\$ 3,186.88
										Labor Surcharge RT	
										Sub-Total Labor OT	\$ -
										Labor Surcharge OT	
										Subsistence	
TOTAL COST OF LABOR											
										\$ 3,186.88	
										\$ 2,223.58	
										\$ -	
										\$ 414.29	
										\$ 222.36	
										\$ -	
										\$ 6,047.11	
TOTAL THIS REPORT											

13% MARK-UP ON LABOR COST
10% MARK-UP ON EQUIPMENT, MATERIALS AND TRUCKING COST
7% MARK-UP ON SUBCONTRACTOR AND SPECIALISTS COST

LAS ANIMAS CONCRETE
P.O. BOX 507
Santa Cruz, CA 95061
831/426-7280

Sales Invoice 188277

Invoice Date: 02/22/2024
Due Date: 03/23/2024
Printed Date: 02/23/2024
Page: 1

Bill To:

Anderson Pacific
Attention: Accounts Payable
1370 Norman Avenue
Santa Clara, CA 95054

Ship To:

ALTA VIA

Customer ID	Purchase Order	Terms	Ship Via	F.O.B.	Sales Person	Ship From	Source
AND2	ALTA VIA	1% 15 Net 30			CN	WHSE	

Order Qty	U.O.M.	Description	Unit Price	Tax	Extended Price
6.00	YD	2.00 SK SAND SLURRY 379637	118.00000	Y	708.00
6.00	YD	Freight Chg - Bonny Doon, BC town 379637	25.00000	N	150.00
20.00	EA	Standby Time	1.50000	N	30.00
1.00	YD	AB219	50.00000	N	50.00

RECEIVED
FEB 27 2024
APEC

Non Taxable Subtotal	230.00
Taxable Subtotal	708.00
Order Discount	0.00
Shipping/Handling	0.00
Tax	63.72
Order Total	1,001.72

IMPORTANT: SEE REVERSE FOR INFORMATION REGARDING MECHANICS LIEN LAWS, CREDIT SALE INFORMATION, & TERMS AND CONDITIONS OF SALE.

SOLD BY

Las Animas Concrete & Building Supply, Inc.

Agenda: 4.4.24
Item: 10c

Mailing Address: P.O. Box 507
Santa Cruz, CA 95061

Business Address:
146 ENCINAL STREET
SANTA CRUZ, CA 95060
831/426-7280

CAUTION: Freshly mixed concrete may cause skin irritation on prolonged exposure. Avoid direct contact where possible and wash exposed skin areas promptly with water. If any cementitious materials get into the eye, rinse immediately and repeatedly with water and get prompt medical attention. Keep out of reach of children.

01

SOLD TO: ANDERSON PACIFIC

SHIP TO: ALTA VIA
X CLEAR CREEK

TIME	MIX NO.	CU. YDS./METERS THIS LOAD	YDS./METERS ORD'D	USE	DRIVER/TRUCK	MAP COORDINATE	PLANT/TRANSACTION #
12:36 PM	003	6.00 yd	6.00 yd		SCHALOW 119		
DATE	NO. OF LOADS	ACCUM. YDS/METERS	BATCH #	WATER TRIM	SLUMP	TICKET NUMBER	
02/22/24	1	6.00 yd	1		4.00 in	379637	

NOTICE: MY SIGNATURE BELOW INDICATES THAT I HAVE READ THE HEALTH WARNING NOTICE AND SUPPLIER WILL NOT BE RESPONSIBLE FOR ANY DAMAGE CAUSED WHEN DELIVERING INSIDE CURB LINE.

WEIGHMASTER CERTIFICATE: THIS IS TO CERTIFY that the following described commodity was weighed, measured or counted by a weighmaster, whose signature is on this certificate, who is a recognized authority of accuracy, as prescribed by Chapter 7 (commencing with Section 12700) of Division 5 of the California Business and Professions Code, administered by the Division of Measurement Standards of the California Department of Food and Agriculture.

LAS ANIMAS CONCRETE & BUILDING SUPPLY, INC. AND DRIVER OF TRUCK are released from any responsibility of addition to colors due to variations in cement and aggregate materials or admixtures, and for damages which may be incurred in delivering materials across the curb or property line. Claims will not be allowed unless made at the time this material was delivered. ADDITIONAL WATER ADDED TO THIS CONCRETE WILL REDUCE IT'S STRENGTH. ANY WATER ADDED IS AT CUSTOMER'S OWN RISK.

JOB SITE CYLINDER TEST: YES NO
 Water Added _____ Gals. to full load YES
 On Job At _____ Gals. to 2/3 load YES
 Customer's Request _____ Gals. to 1/3 load YES
 AUTHORIZED BY: _____

LAS ANIMAS CONCRETE & BUILDING SUPPLY, INC. WEIGHMASTER
 WEIGHED AT: * CASON F.
 BY: _____ DEPUTY

CONCRETE IS A PERISHABLE COMMODITY AND BECOMES THE PROPERTY OF THE PURCHASER UPON LEAVING THE PLANT. ANY CHANGES OR CANCELLATION OF ORIGINAL INSTRUCTIONS MUST BE TELEPHONED TO OFFICE BEFORE LOADING STARTS.

RECEIVED BY: X

X

QUANTITY	CODE	DESCRIPTION	PRICE CU. YD./METER	EXTENDED PRICE
6.00 yd	003	LA20S2SK SLURRY		
6.00 yd	FRT04	BOULDER CREEK/BROOKDALE/BONNY DOON		
1.00 /L	ENV	ENVIRONMENTAL FEE		
1.00 /L	FUEL	FUEL SURCHARGE		

LEAVE PLANT	ARRIVE JOB	START UNLOAD	FINISH UNLOAD	ARRIVE PLANT	TOTAL TIME
105	135	140	230		
DELAY EXPLANATION/CYLINDER TEST TAKEN			MINUTES STANDBY TIME:		
<input type="checkbox"/> JOB NOT READY <input type="checkbox"/> SLOW POUR OR PUMP <input type="checkbox"/> TRUCK AHEAD ON JOB <input type="checkbox"/> CONTRACTOR BROKE DOWN <input type="checkbox"/> ADDED WATER			<input type="checkbox"/> TRUCK BROKE DOWN <input type="checkbox"/> ACCIDENT <input type="checkbox"/> CITATION <input type="checkbox"/> OTHER		
Five (5) minutes per yd./meter free unloading time allowed. Additional unloading time charged at current hourly truck rate.					

SUB TOTAL
TAX TOTAL
TOTAL

ADDITIONAL CHARGE 1. _____

ADDITIONAL CHARGE 2. _____

GRAND TOTAL ▶

Track Driver User Disp Ticket Num Ticket ID Time Date

12:36 2/22/24
CONTROL NO. D379637

IMPORTANT: SEE REVERSE FOR INFORMATION REGARDING MECHANICS LIEN LAWS, CREDIT SALE INFORMATION, & TERMS AND CONDITIONS OF SALE.

SOLD BY

Las Animas Concrete & Building Supply, Inc.

Agenda: 4.4.24
Item: 10c

Mailing Address: P.O. Box 507
Santa Cruz, CA 95061

Business Address:
146 ENCINAL STREET
SANTA CRUZ, CA 95060
831/426-7280

CAUTION: Freshly mixed concrete may cause skin irritation on prolonged exposure. Avoid direct contact where possible and wash exposed skin areas promptly with water. If any cementitious materials get into the eye, rinse immediately and repeatedly with water and get prompt medical attention. Keep out of reach of children.

SOLD TO: ANDERSON PACIFIC

SHIP TO: ALTA VIA
X CLEAR CREEK

TIME	MIX NO.	CU. YDS./METERS THIS LOAD	YDS./METERS ORD'D	USE	DRIVER/TRUCK	MAP COORDINATE	PLANT/TRANSACTION #
12:36 PM	003	6.00 yd	6.00 yd		SCHALOW 119		
DATE	NO. OF LOADS	ACCUM. YDS./METERS	BATCH #	WATER TRIM	SLUMP	TICKET NUMBER	
02/22/24	1	6.00 yd	1		4.00 in	379637	

NOTICE: MY SIGNATURE BELOW INDICATES THAT I HAVE READ THE HEALTH WARNING NOTICE AND SUPPLIER WILL NOT BE RESPONSIBLE FOR ANY DAMAGE CAUSED WHEN DELIVERING INSIDE CURB LINE.

LAS ANIMAS CONCRETE & BUILDING SUPPLY, INC. AND DRIVER OF TRUCK are released from any responsibility of addition to colors due to variations in cement and aggregate materials or admixtures, and for damages which may be incurred in delivering materials across the curb or property line. Claims will not be allowed unless made at the time this material was delivered. ADDITIONAL WATER ADDED TO THIS CONCRETE WILL REDUCE IT'S STRENGTH. ANY WATER ADDED IS AT CUSTOMER'S OWN RISK.

WEIGHMASTER CERTIFICATE: THIS IS TO CERTIFY that the following described commodity was weighed, measured or counted by a weighmaster, whose signature is on this certificate, who is a recognized authority of accuracy, as prescribed by Chapter 7 (commencing with Section 12700) of Division 5 of the California Business and Professions Code, administered by the Division of Measurement Standards of the California Department of Food and Agriculture.

JOB SITE CYLINDER TEST: YES NO
 Water Added _____ Gals. to full load YES
 On Job _____ Gals. to 2/3 load YES
 At _____ Gals. to 1/3 load YES
 Customer's Request _____ Gals. to 1/3 load YES

AUTHORIZED BY: X

LAS ANIMAS CONCRETE & BUILDING SUPPLY, INC. **WEIGHMASTER**
 WEIGHED AT: * CASON F. [Signature]
 BY: _____ DEPUTY

CONCRETE IS A PERISHABLE COMMODITY AND BECOMES THE PROPERTY OF THE PURCHASER UPON LEAVING THE PLANT. ANY CHANGES OR CANCELLATION OF ORIGINAL INSTRUCTIONS MUST BE TELEPHONED TO OFFICE BEFORE **LOADING** STARTS.

RECEIVED BY: X

QUANTITY	CODE	DESCRIPTION	PRICE CU. YD./METER	EXTENDED PRICE
6.00 yd	003	LA20S2SK SLURRY		
6.00 yd	FRT04	BOULDER CREEK/BROOKDALE/BONNY DOON		
1.00 /L	ENV	ENVIRONMENTAL FEE		
1.00 /L	FUEL	FUEL SURCHARGE		

LEAVE PLANT	ARRIVE JOB	START UNLOAD	FINISH UNLOAD	ARRIVE PLANT	TOTAL TIME
105	135	140	230		
DELAY EXPLANATION/CYLINDER TEST TAKEN			MINUTES STANDBY TIME:		
<input type="checkbox"/> JOB NOT READY <input type="checkbox"/> SLOW POUR OR PUMP <input type="checkbox"/> TRUCK AHEAD ON JOB <input type="checkbox"/> CONTRACTOR BROKE DOWN <input type="checkbox"/> ADDED WATER <input type="checkbox"/> TRUCK BROKE DOWN <input type="checkbox"/> ACCIDENT <input type="checkbox"/> CITATION <input type="checkbox"/> OTHER			Five (5) minutes per yd./meter free unloading time allowed. Additional unloading time charged at current hourly truck rate.		

SUB TOTAL
 TAX TOTAL
 TOTAL
 ADDITIONAL CHARGE 1. _____
 ADDITIONAL CHARGE 2. _____
GRAND TOTAL ▶

Truck Driver User Disp Ticket Num Ticket ID Time Date
 12:36 2/22/24
 CONTROL NO. **379637**

Description of Work:

Patch and pave potholes on Monan Dr.

EQUIP. NO.	EQUIPMENT	OT/Delay Factor	HOURS		HOURLY RATE	EXTENDED AMOUNTS	LABOR	HOURS		HOURLY RATE	EXTENDED AMOUNTS
			RT	OT				RT	OT		
1018	FORD F150 PICKUP TRUCK	1	8		\$ 37.61	\$ 300.88	49	8		\$ 105.82	\$ 846.56
							J. Swain				
1020	FORD F250 CREW TRUCK - UTILITY	1	8		\$ 42.39	\$ 339.12	13	8		\$ 99.79	\$ 798.32
							T. Thurman				
7006	FORD F650 BOBTAIL DUMP TRUCK - 5 CY	1	8		\$ 73.34	\$ 586.72	41	4		\$ 76.50	\$ 306.00
							J. Ramos				
3022	KOBELCO SK 45SRX-6E	1	8		\$ 48.03	\$ 384.24	LA3			\$ 63.32	\$ -
							D. Lizaola Ramos				
3006	BOBCAT S-650 SKID-STEER LOADER	1	8		\$ 46.72	\$ 373.76	1	4		\$ 71.15	\$ 284.60
							Jesus Ramos				
1026	FORD F250 CREW TRUCK - UTILITY	1	8		\$ 42.39	\$ 339.12	1	8		\$ 71.15	\$ 569.20
							A. Flores				
0		1	8		\$ -	\$ -	8	8		\$ 71.93	\$ 575.44
							CONSTRUCTION SPECIALIST				
0		1	8		\$ -	\$ -	1	8		\$ 71.15	\$ 569.20
							J. Gomez				
0		1	8		\$ -	\$ -	1	8		\$ 71.15	\$ 569.20
							Chance Gulodotti				
0		1	8		\$ -	\$ -	1	8		\$ 71.15	\$ 569.20
							G. Musante				
0		1	8		\$ -	\$ -	0			\$ -	\$ -
0		1	8		\$ -	\$ -	0			\$ -	\$ -
										\$ -	\$ -
										\$ -	\$ -
										\$ -	\$ -
MATERIAL and/or TRUCKING											
Description	No. Units	Unit Cost	Amount				Sub-Total Labor RT		INCLUDED		\$ 4,518.52
Rental A-Tool Shed- 1679624-5- vib plate	1.00 LS	\$140.00	\$140.00				Labor Surcharge RT				
Material Olive Springs- 304315, 304346	1.00 LS	\$1,026.25	\$1,026.25				Sub-Total Labor OT		INCLUDED		\$ -
Material Graniterock- 300076	1.00 LS	\$170.86	\$170.86				Labor Surcharge OT				
	1.00 LS	\$0.00	\$0.00				Subsistence				
	1.00 LS	\$0.00	\$0.00								
WORK DONE BY SUBCONTRACTOR and/or SPECIALISTS											
Description	No. Units	Unit Cost	Amount				TOTAL COST OF LABOR				\$ 4,518.52
	1.00 LS	\$0.00	\$0.00								\$ -
	1.00 LS	\$0.00	\$0.00								\$ 3,660.95
	1.00 LS	\$0.00	\$0.00								\$ -
TOTAL COST OF EQUIPMENT, MATERIALS AND TRUCKING											
TOTAL COST OF SUBCONTRACTOR AND SPECIALISTS											
13% MARK-UP ON LABOR COST											
10% MARK-UP ON EQUIPMENT, MATERIALS AND TRUCKING COST											
7% MARK-UP ON SUBCONTRACTOR AND SPECIALISTS COST											
TOTAL THIS REPORT											\$ 9,132.97

9912

ANDERSON PACIFIC

Engineering Construction, Inc.

BILLING INFORMATION:

NAME: ANDERSON PACIFIC
ADDRESS: 1370 NORMAN AVE
CITY/STATE/ZIP: SANTA CLARA CA
PHONE: 408.770.9403

216

DAILY EXTRA WORK REPORT

DATE PERFORMED 2/23/2024

WORK PERFORMED AT THE DIRECTION OF:

SAN LORENZO WATER DISTRICT

DESCRIPTION OF WORK:

PAVE / PAVE FLORES MONAN DR.

CONTRACTOR JOB NO.

2202

CONTRACTOR REPORT NO.

EQUIP NO.	EQUIPMENT	HOURS	HOURLY/DAILY RATE	EXTENDED AMOUNTS	P.R. NO.	LABOR	HOURS	HOURLY RATE	EXTENDED AMOUNTS
1018	FORD F-150	8			F	JOE SWAIN	REG. 8		
1020	UTILITY TRUCK	8					O.T.		
1026	UTILITY TRUCK	8			03	TOMMY THURMAN	REG. 8		
3022	MINI EX	8				JOSUS RAMOS	O.T.		
7006	BURSTALL	4			L1	CHIBEY RAMOS	REG. 4		
3005	BURBANK	8			T1	CHIBEY RAMOS	O.T.		
					L1	ANA FLORES	REG. 8		
					05	JOSE GOMEZ	O.T.		
					L1	CHARLE GUIDATI	REG. 2		
					L1	GEORGE MASSUNTE	O.T.		

MATERIAL AND/OR WORK DONE BY SPECIALISTS

DESCRIPTION	NO. UNIT	UNIT COST	EXTENDED
A TAIL SALED 1679624-5			
GLASS SPRINGS 304315	304346		
GRANITE - 30076			

TOTAL COST OF EQUIPMENT, MATERIALS AND WORK

TOTAL COST OF LABOR

A



B

TOTAL A & B

MARKUP ON EQUIPMENT, MATERIAL AND WORK COST _____ %

ACCEPTED:

[Signature]
CONTRACTOR'S REPRESENTATIVE

OWNER/AGENT

TOTAL THIS REPORT



3700 SOQUEL AVE.
 SANTA CRUZ, CA 95062
 www.stoolshed.com
 831-477-7133 Phone
 831-477-7189 Fax



Status: Closed

Invoice #: 1679624-5

Invoice Date: Fri 2/23/2024

Date Out: Fri 2/23/2024 7:04AM

Operator: LIZARDE, FRANCISCO

Terms: 2%-10 / NET 30

ANDERSON PACIFIC ENGR.

Phone 408-970-9900

1370 NORMAN AVE
 Santa Clara, CA 95064-2047

Job Descr: 2202

PO #: 2202

Job No: 2202

Picked up by: JOSE GOMEZ

Sales Rep: LIZARDE, FRANCISCO

Qty	Key	Items	Rental Period	Status	Each	Price
1	1712#440	SMALL VIBRATORY PLATE COMPACTOR	Fri 2/23/2024 7:04AM to Fri 2/23/2024 4:34PM	Returned	\$125.00	\$125.00
		4Hrs \$90.00 1day \$125.00 1week \$425.00 4weeks \$900.00				

RECEIVED
 FEB 26 2024
 APEC

THANK YOU FOR YOUR BUSINESS

REMIT TO: 3700 SOQUEL AVE., SANTA

CRUZ, CA 95062

Contract Signature:

Jose Gomez

JOSE GOMEZ

Date: 02/23/2024

Modification # 1

Rental Contract

This is a contract. The back of this contract contains important terms and conditions including lessor's disclaimer from liability for injury or damage and details of customer's obligations. These terms and conditions are a part of the contract - READ THEM!

If equipment does not function properly notify A Tool Shed, Inc. within 30 minutes of occurrence or no refund or allowance will be made.

Customer is responsible for FUEL and FLAT TIRES

A FINANCE CHARGE of 1.5% per month (ANNUAL PERCENTAGE RATE OF 18%) will be assessed against overdue amounts

On behalf of myself or my firm, that I am an agent of and authorized to sign for, I have read and understand, and have agreed to be bound by the terms on both sides of this agreement, in addition, I either know how to properly operate the equipment described above or have asked, received and understand instructions provided to me regarding the proper operation of the equipment described above. I also acknowledge that A Tool Shed, Inc. has provided a copy of this agreement to me.

Rental:	\$125.00
EPP:	\$15.00
Subtotal:	\$140.00
Total:	\$140.00
Paid:	\$0.00
Amount Due:	\$140.00

Signature:

JOSE GOMEZ

MONDAY - SATURDAY 7:00am - 5:00pm, SUNDAY - CLOSED

Printed On: Fri 2/23/2024 5:21:15PM

Software by Point-of-Rental Software www.point-of-rental.com

Modification #3

Contract-Params SQL.rpt (11)



CAMPBELL 900 Dell Ave. (408) 378-4921
MORGAN HILL 95 E. Main Ave. (408) 779-7368
SANTA CLARA 2550 Lafayette St. (408) 727-0822
SALINAS 210 W. Market St. (831) 424-7368
SANTA CRUZ 3700 Soquel Ave. (831) 477-7133
WATSONVILLE 285 W. Beach St. (831) 722-0334
HOLLISTER 2610 San Juan Rd. (831) 638-1999
GREENFIELD 60 4th Street (831) 856-3131
CORPORATE OFFICE - 3700 Soquel Ave. - Santa Cruz, CA 95062 - (831) 477-7793

Agenda: 4.4.24
Status: Open Item: 100
 Contract #: 1679624-5

Date Out: Fri 2/23/2024 7:04AM

Operator: LIZARDE, FRANCISCO
 Terms: 2%-10 / NET 30

Customer #: 187

ANDERSON PACIFIC ENGR.
 1370 NORMAN AVE
 Santa Clara, CA 95054-2047

Phone 408-970-9900

Job Descr: 2202

PO #: 2202

Job No: 2202

Picked up by: JOSE GOMEZ

Sales Rep: LIZARDE, FRANCISCO

Qty	Key	Items	Ser#	Status	Agreed Return Date	Price
1	1710	SMALL VIBRATORY PLATE COMPACTOR		Out	Sat 2/24/2024 7:04AM	\$125.00
4Hrs \$90.00 1day \$125.00 1week \$425.00 4weeks \$900.00						
Always wear eye, dust & foot protection at all times whenever operating this equipment.						

Total for Rental \$125.00

65' STICK BOOMS + 6 TON EXCAVATORS COMING VERY SOON!

WRITTEN INSTRUCTIONS: I have been given and agreed to read instructions before operating or allowing rented equipment to be operated or used.

EQUIPMENT PROTECTION PLAN

I ACCEPT the additional fee of 12% of the total rental, lessor agrees to waive certain claims for damage to the rented vehicle(s) and or equipment as specified on reverse. Customer is responsible for all tire damages regardless of fault. Customer understands that Equipment Protection Plan is not insurance. Equipment Protection Plan covers the first \$5,000.00 of accidental damage.

Rental Contract

This is a contract. The back of this contract contains important terms and conditions including lessor's disclaimer from liability for injury or damage and details of customer's obligations. These terms and conditions are a part of this contract - READ THEM!

If equipment does not function properly notify A Tool Shed, Inc. within 30 minutes of occurrence or no refund or allowance will be made.

Customer is responsible for FUEL and FLAT TIRES.

A FINANCE CHARGE of 1.5% per month. (ANNUAL PERCENTAGE RATE OF 18%) will be assessed against overdue amounts.

On behalf of myself or my firm, that I am an agent of and authorized to sign for, I have read, and understand, and have agreed to be bound by the terms on both sides of this agreement, in addition, I either know how to properly operate the equipment described above or have asked, received and understand instructions provided to me regarding the proper operation of the equipment described above. I also acknowledge that A Tool Shed, Inc. has provided a copy of this agreement to me.

Rental:	\$125.00
EPP:	\$15.00
Subtotal:	\$140.00
Total:	\$140.00
Paid:	\$0.00
Amount Due:	\$140.00

Signature:

Jose Gomez

JOSE GOMEZ



OLIVE SPRINGS QUARRY, INC.

P.O. Box 747 • Soquel, CA 95073

Quarry (831) 475-1610

Fax (831) 475-0880

Agenda: 4.4.24

Item: 10c

INVOICE

CUSTOMER NO. 12250
 INVOICE DATE 02/26/24
 INVOICE NUMBER 147859
 JOB/PO/LOC 2202

RECEIVED

FEB 29 2024

APEC

Anderson Pac. Eng. Const. Inc.
 1370 Norman Ave.
 Santa Clara CA 95040

DATE	TICKET #	QTY.	DESCRIPTION	PRICE	AMOUNT
02/23/24	304315	6.06	1/2" MM HMA	100.50	609.03
02/23/24	304346	3.05	1/2" MM HMA	100.50	306.53
02/23/24	304346	1.73	Waste Material Dump - w/new purchase	15.00	25.95
RETURNED CHECK CHARGE \$20.00. INVOICES OVER 30 DAYS OLD ARE SUBJECT TO A FINANCE CHARGE OF 1 1/2% PER MONTH, AN ANNUAL RATE OF 18%.				SUB-TOTAL	941.51
				SALES TAX	84.74
				AMOUNT DUE	1026.25

A DISCOUNT OF \$18.22 ALLOWED IF PAID BY 3/10/2024

2022



P.O. Box 50001
Watsonville, CA 95077-5001
(831) 768-2000

Customer: 10228

Invoice No: 2143620
Invoice Date: 02/24/2024
Job No: 2202
Order No: 959149
Job PO No:
Job Name: 2202 Alta Via Pipeline Replacement Brook
Job Street: 100 Lockwood Ln
Job City: Santa Cruz

Anderson Pacific Engin Const Inc
1370 Norman Avenue
Santa Clara, CA 85054

RECEIVED
FEB 28 2024
APEC

Building Materials

Product	Qty	Product Price	Amount	Freight Price	Freight Amount	Additional Charges	Tax Amount	Total
Date: 02/23/2024 Ticket: 300076 Location: Santa Cruz Building Materials								
1001954 BUCKET LID FITS 3-1/2 & 5 GAL-1001954	2.00 EA	2.10	4.20				9.25%	4.59
1001955 BUCKET PLASTIC 5 GAL-1001955	2.00 EA	7.70	15.40				9.25%	16.82
1002687 3 ROW POLYPROP SEAL COAT BRUSH-1002687	1.00 EA	7.80	7.80				9.25%	8.52
1003876 SS-1 GALLON-1003876	10.00 Gal	12.90	129.00				9.25%	140.93
Totals for Ticket 300076			166.40	0.00	0.00		14.46	170.86

Product	Freight	Additional	Tax	Total
Invoice Totals	0.00	0.00	14.46	170.86

For questions or additional info, contact Customer Service at (831) 768-2120 or CustomerServiceAlt@graniterock.com

SHORT PAY POLICY

Our philosophy of total customer satisfaction can be summarized with the following statement:
If you are not satisfied for any reason... don't pay us for it!

This means that if any part of this invoice is incorrect or if you were unhappy with the products or services received from this transaction, let us know right now. Simply scratch out the related line item, write a brief note about the problem, and return a copy of this invoice along with your check for the remaining balance. Someone will contact you immediately to resolve the problem.

Please Make Checks Payable to:

Granite Rock Company
P.O. Box 50001
Watsonville, CA 95077-5001

Customer No: 10228

Invoice No: 2143620

Invoice Date: 02/24/2024

Sold To: Anderson Pacific Engin Const Inc
1370 Norman Avenue
Santa Clara, CA 85054

Total Due by 03/25/2024 \$170.86

Payment Enclosed

If haul charges are indicated separately above, the passage of material is at the plant, with delivery provided by Graniterock for customer's account.

Santa Cruz Building Materials
303 Coral Street
Santa Cruz, CA 95060
Phone: 831-471-3400
Fax: 831-471-3401



Ticket Number

300076

Date: 02/23/2024

Customer: 10228
Sold To:
Anderson Pacific Engin Const Inc
1370 Norman Avenue
Santa Clara, CA 95054

NOT AN INVOICE

Delivery Location:
N/A

NOS #: 959149
Job Name: 2202 Alta Via Pipeline Replacement Brookdale
Job/PO #: 2202
Sold By: Michael Furniss

Product	Description	Quantity
1001954	BUCKET LID FITS 3-1/2 & 5 GAL-1001954	2.00 EA
1001955	BUCKET PLASTIC 5 GAL-1001955	2.00 EA
1002687	3 ROW POLYPROP SEAL COAT BRUSH-1002687	1.00 EA
1003876	SS-1 GALLON-1003876	10.00 GALS

TERMS AND CONDITIONS

For purchases of natural stone, brick, wallboard, color additives, and sacked goods, all sales are final and no returns, exchanges, or refunds allowed. For all special orders, all sales are final and no returns, exchanges, or refunds allowed. For all other purchases, returns, exchanges and refunds will be allowed only after the assessment of a 15% restocking charge plus any additional return fee assessed by the original product vendor, and only upon presentation of the original receipt for such materials. Under no circumstances will Graniterock accept liability for consequential damages. Natural stone and rock are products of nature and are not man-made. They contain irregularities in color, shape, and size. Please make your selection carefully, as Graniterock is unable to guarantee consistency in and takes no responsibility for variations in color, texture, shape, or size. In addition, natural stone and rock products are subject to natural weathering, and Graniterock takes no responsibility for such weathering after installation. Graniterock is not responsible for overloaded vehicles, damage due to loading, damage due to hauling, and/or loads not properly tied down. Graniterock is not responsible for your transport or hauling of product in your own vehicle. Hauling and loading thereof may cause damage to your vehicle. If you choose to transport or haul product in your own vehicle, you do so at your own risk. Graniterock is not liable for cosmetic or other damage to commercial or personal vehicles used to haul our products. Graniterock reserves the right to refuse to load any vehicle if deemed unsafe, inappropriate or unable to load. Graniterock delivery drivers will endeavor to place material where designated by the customer, but Graniterock will not deliver to a location that is unsafe and reserves the right to refuse delivery over hazardous or unsafe terrain. Excess unloading time will be charged at the prevailing rate. Graniterock can provide all product expertise and product knowledge it has access to, but customers are solely responsible for the accuracy of their project estimates and Graniterock accepts no responsibility for the accuracy of such estimates. Customers will be charged a deposit for use of pallets. A per pallet refund will be issued, only for pallets purchased from Graniterock and returned. An original receipt is required for pallet refunds and returns.

Jose Gomez

Received by:

Printed by: Michael Furniss on 02/23/2024 at 07:24 AM



This product can expose you to chemicals, including Crystalline Silica, which is known to the State of California to cause cancer. For more information go to www.P65Warnings.ca.gov.



Description of Work: 2" Shutoff and installation of 2" tie-in

EQUIP. NO.	EQUIPMENT	OT/Delay Factor	HOURS		HOURLY RATE	EXTENDED AMOUNTS	LABOR	HOURS		HOURLY RATE	EXTENDED AMOUNTS
			RT	OT				RT	OT		
1018	FORD F150 PICKUP TRUCK	1	4		\$ 37.61	\$ 150.44	49	4		\$ 105.82	\$ 423.28
1020	FORD F250 CREW TRUCK - UTILITY	1	4		\$ 42.39	\$ 169.56	1	4		\$ 71.15	\$ 284.60
7006	FORD F650 BOBTAIL DUMP TRUCK - 5 CY	1	4		\$ 73.34	\$ -	8	4		\$ 71.93	\$ 287.72
3022	KOBELCO SK 45SRX-6E	1	4		\$ 48.03	\$ -	LA3	4		\$ 63.32	\$ -
3006	BOBCAT S-650 SKID-STEER LOADER	1	4		\$ 46.72	\$ -	1	4		\$ 71.15	\$ 284.60
1026	FORD F250 CREW TRUCK - UTILITY	1	4		\$ 42.39	\$ 169.56		4		\$ -	\$ -
0		1			\$ -	\$ -				\$ -	\$ -
0		1			\$ -	\$ -				\$ -	\$ -
0		1			\$ -	\$ -				\$ -	\$ -
0		1			\$ -	\$ -				\$ -	\$ -
MATERIAL and/or TRUCKING											
Description		No. Units			Unit Cost	Amount					
Material	Scarborough Home Center- 420899/2	1.00	LS		\$88.22	\$88.22		INCLUDED			\$ 1,280.20
		1.00	LS		\$0.00	\$0.00		INCLUDED			\$ -
		1.00	LS		\$0.00	\$0.00		INCLUDED			\$ -
		1.00	LS		\$0.00	\$0.00					\$ -
		1.00	LS		\$0.00	\$0.00					\$ -
WORK DONE BY SUBCONTRACTOR and/or SPECIALISTS											
Description		No. Units			Unit Cost	Amount					
		1.00	LS		\$0.00	\$0.00					\$ -
		1.00	LS		\$0.00	\$0.00					\$ -
		1.00	LS		\$0.00	\$0.00					\$ -
TOTAL COST OF EQUIPMENT, MATERIALS AND TRUCKING											
TOTAL COST OF SUBCONTRACTOR AND SPECIALISTS											
13% MARK-UP ON LABOR COST											
10% MARK-UP ON EQUIPMENT, MATERIALS AND TRUCKING COST											
7% MARK-UP ON SUBCONTRACTOR AND SPECIALISTS COST											
TOTAL THIS REPORT											\$ 2,082.18

SCARBOROUGH HOME CENTER, INC.
9470 HIGHWAY 9, BEN LOMOND 95005
MAIL: P.O. BOX 66599
SCOTT'S VALLEY, CA 95067
PHONE: (831) 336-5142

30 DAYS** + RECEIPT REQUIRED ON
 ALL RETURNS / EXCHANGES

224

9909

Customer No. 12617	Job No. 2202	Purchase Order No. 2202	Reference ALTA VIA WATER MAIN	Terms 1% 10TH, NET 11TH,	Clerk CTB	Date 2/28/24	Time 1:52
-----------------------	-----------------	----------------------------	----------------------------------	-----------------------------	--------------	-----------------	--------------

Sold To
 * ANDERSON PACIFIC ENGINEERING
 1370 NORMAN AVE.
 SANTA CLARA, CA 95054
 (408) 970-9900

Ship To

DOC# 420899/2

 * INVOICE *

TERM#568

SLSPR: 00 DEFAULT
 TAX : 200 SALES TAX: S CRUZ COU

SHIPPED	ORDERED	UM	SKU	DESCRIPTION	UNITS	PRICE/PER	EXTENSION
1		EA	2062230	BLADE SAWZAL 9" 5-8T PK5	1	26.99 /EA	26.99 *
1		EA	41683	GALV NIPPLE 2X7	1	17.99 /EA	17.99 *
1		EA	47836	CAPS GALV 2"	1	6.99 /EA	6.99
1		EA	47839	SQUARE PLUG GLV 2"	1	6.99 /EA	6.99
1		EA	4066494	GALV 45DEG ELL 2 IN	1	15.99 /EA	15.99
1		EA	4126157	NIPPLE GALV 2"X6"	1	9.99 /EA	9.99
					88.22	TAXABLE	84.94
						NON-TAXABLE	0.00
						SUBTOTAL	84.94
						TD DISCOUNT	-4.00
						TAX AMOUNT	7.28
						TOTAL AMOUNT	88.22

** AMOUNT CHARGED TO STORE ACCOUNT **
 (GOMEZ, JOSE)

Sosi Gomez

X

Received By

Excavate, install, backfill line for Howard's water service @ 126 Moonridge.

Description of Work:

EQUIP. NO.	EQUIPMENT	OT/Delay Factor	HOURS		HOURLY RATE	EXTENDED AMOUNTS	LABOR	HOURS		HOURLY RATE	EXTENDED AMOUNTS
			RT	OT				RT	OT		
1018	FORD F150 PICKUP TRUCK	1	8		\$ 37.61	\$ 300.88	FOREMAN	8		\$ 105.82	\$ 846.56
							J. Swain				
1020	FORD F250 CREW TRUCK - UTILITY	1	8		\$ 42.39	\$ 339.12	OPERATOR 3	4		\$ 99.79	\$ 399.16
							T. Thurman				
1026	FORD F250 CREW TRUCK - UTILITY	1	8		\$ 42.39	\$ 339.12	CONSTRUCTION SPECIALIST	8		\$ 71.93	\$ 575.44
							J. Gomez				
3022	KOBELCO SK 45SRX-6E	1	4		\$ 48.03	\$ 192.12	LAB APP 3			\$ 63.32	\$ -
							D. Lizola Ramos				
3006	BOBCAT S-650 SKID-STEER LOADER	1			\$ 46.72	\$ -	LABORER 1	4		\$ 71.15	\$ 284.60
							T. Thurman				
0		1			\$ -	\$ -	LABORER 1	8		\$ 71.15	\$ 569.20
							J. Ramos				
0		1			\$ -	\$ -	LABORER 1	8		\$ 71.15	\$ 569.20
							A. Flores				
0		1			\$ -	\$ -	LABORER 1	8		\$ 71.15	\$ 569.20
							G. Musante				
0		1			\$ -	\$ -	0			\$ -	\$ -
0		1			\$ -	\$ -	0			\$ -	\$ -
0		1			\$ -	\$ -	0			\$ -	\$ -
0		1			\$ -	\$ -	0			\$ -	\$ -
MATERIAL and/or TRUCKING											
Description		No. Units			Unit Cost	Amount					
Material	Scarborough Home Center- 629343/5	1.00	LS		\$21.54	\$21.54		INCLUDED			\$ 3,813.36
Material	Scarborough Home Center- 629348/5	1.00	LS		\$130.73	\$130.73					\$ -
Material	Scarborough Home Center- 629297/5	1.00	LS		\$78.35	\$78.35		INCLUDED			\$ -
		1.00	LS		\$0.00	\$0.00					\$ -
		1.00	LS		\$0.00	\$0.00					\$ -
WORK DONE BY SUBCONTRACTOR and/or SPECIALISTS											
Description		No. Units			Unit Cost	Amount					
		1.00	LS		\$0.00	\$0.00					\$ -
		1.00	LS		\$0.00	\$0.00					\$ -
		1.00	LS		\$0.00	\$0.00					\$ -
TOTAL COST OF LABOR											
											\$ 3,813.36
											\$ 1,401.86
											\$ -
											\$ 495.74
											\$ 140.19
											\$ -
											\$ 5,851.14
TOTAL THIS REPORT											
13% MARK-UP ON LABOR COST											
10% MARK-UP ON EQUIPMENT, MATERIALS AND TRUCKING COST											
7% MARK-UP ON SUBCONTRACTOR AND SPECIALISTS COST											

BILLING INFORMATION:

NAME: Anderson Pacific
 ADDRESS: 1370 NORMAN AVE
 CITY/STATE/ZIP: SANTA CLARA, CA
 PHONE: 408.970.9900

226

DAILY EXTRA WORK REPORT

DATE PERFORMED 3/4/2024

WORK PERFORMED AT THE DIRECTION OF: SAN LORENZO WATER DISTRICT

CONTRACTOR JOB NO. 2202

DESCRIPTION OF WORK: UNDER THE DIRECTION PROVIDED BY S.L.W.D - AP&E

EQUIP NO.	EQUIPMENT	HOURS	HOURLY/DAILY RATE	EXTENDED AMOUNTS	P.R. NO.	LABOR	HOURS		HOURLY RATE	EXTENDED AMOUNTS
							REG.	O.T.		
1018	Ford F-150	8			F	JOE SWAIN	8			
1020	UTILITY TRUCK	8			CS	JOSE GOMEZ	8			
1026	UTILITY TRUCK	8			OS	TOMMY THURMAN	4			
2022	MINI EX	4			L1	TOMMY THURMAN	4			
					L1	CAREY RAMOS	8			
					L1	ANIA FLORES	8			
					L1	GEORGE MFSURTE	8			
MATERIAL AND/OR WORK DONE BY SPECIALISTS										
	DESCRIPTION	NO. UNIT	UNIT COST	EXTENDED	SUB-TOTAL					
	SCARBOROUGH 629343/S				PAYROLL BURDEN AND/OR MARKUPS					
	SCARBOROUGH 629348/S				TOTAL COST OF LABOR					
TOTAL COST OF EQUIPMENT, MATERIALS AND WORK										A
TOTAL A & B										B

EXCAVATED / INSTALLED / BACKFILLED HOWARIS NEW SERVICE LINE @ 126 MAIN RD @

ACCEPTED: _____
 CONTRACTOR'S REPRESENTATIVE

MARKUP ON EQUIPMENT, MATERIAL AND WORK COST _____ %

TOTAL THIS REPORT

OWNER/AGENT

SCARBOROUGH BUILDING SUPPLY
12990 HWY 9, BOULDER CREEK
MAIL: P.O. BOX 66599
SCOTT'S VALLEY, CA 95067
PHONE: (831) 338-6467

PAGE NO 1

9909

HOWARD SERVICE
LINE

30 DAYS** + RECEIPT REQUIRED ON
ALL RETURNS / EXCHANGES

227

Customer No. 12617	Job No. 2202	Purchase Order No. 2202	Reference ALTA BETA WATER MAIN	Terms 1% 10TH, NET 11TH,	Clerk RMD	Date 3/ 4/24	Time 9:58
-----------------------	-----------------	----------------------------	-----------------------------------	-----------------------------	--------------	-----------------	--------------

Sold To
 * ANDERSON PACIFIC ENGINEERING
 1370 NORMAN AVE.
 SANTA CLARA, CA 95054
 (408) 970-9900

Ship To

DOC# 629343/5

 * INVOICE *

 SLSPR: 00 DEFAULT
 TAX : 500 SALES TAX: S CRUZ COU

SHIPPED	ORDERED	UM	SKU	DESCRIPTION	UNITS	PRICE/PER	EXTENSION
1		EA	4066452	ELBOW 45DEG 1"GALV	1	6.99 /EA	6.99
1		EA	4066551	1" GAL ST 45	1	8.99 /EA	8.99
1		EA	4124491	NIPPLE GALV 1"X2.5"	1	2.99 /EA	2.99
1		EA	4124533	NIPPLE GALV 1"X3.5"	1	2.99 /EA	2.99
						TAXABLE	21.96
						NON-TAXABLE	0.00
						SUBTOTAL	21.96
						TD DISCOUNT	-2.20
						TAX AMOUNT	1.78
						TOTAL AMOUNT	21.54

** AMOUNT CHARGED TO STORE ACCOUNT **
 (GOMEZ, JOSE)

Agenda: 4.4.24
Item: 10c

Jose Gomez

X
Received By

SCARBOROUGH BUILDING SUPPLY
12990 HWY 9, BOULDER CREEK
MAIL: P.O. BOX 66599
SCOTT'S VALLEY, CA 95067
PHONE: (831) 338-6467

PAGE NO 1

9909

HOWARD
 SERVICE LINE

30 DAYS** + RECEIPT REQUIRED ON
 ALL RETURNS / EXCHANGES

228

Customer No. 12617	Job No. 2202	Purchase Order No. 2202	Reference BOULDER CREEK	Terms 1% 10TH, NET 11TH,	Clerk TMT	Date 3/ 4/24	Time 11:25
-----------------------	-----------------	----------------------------	----------------------------	-----------------------------	--------------	-----------------	---------------

Sold To
 * ANDERSON PACIFIC ENGINEERING
 1370 NORMAN AVE.
 SANTA CLARA, CA 95054
 (408) 970-9900

Ship To

DOC# 629348/5

 * INVOICE *

 SLSPR: 00 DEFAULT
 TAX : 500 SALES TAX: S CRUZ COU

TERM#582

SHIPPED	ORDERED	UM	SKU	DESCRIPTION	UNITS	PRICE/PER	EXTENSION
6	BG	SAKBC		QUIKRETE BLACKTOP COMM GRADE 50#	6	19.99 /BG	119.94 *
							119.94
							0.00
							119.94
							10.79
							130.73

Agenda: 4.4.24
 Item: 10c

** AMOUNT CHARGED TO STORE ACCOUNT **
 (ANASTASIO)

X *Allej*

Received By

SCARBOROUGH BUILDING SUPPLY
12990 HWY 9, BOULDER CREEK
MAIL: P.O. BOX 66599
SCOTT'S VALLEY, CA 95067
PHONE: (831) 338-6467

PAGE NO 1

9909
 2" SHUTOFF
 AND INSULATION

30 DAYS** + RECEIPT REQUIRED ON
 ALL RETURNS / EXCHANGES

229

Customer No. 12617	Job No.	Purchase Order No. 2202	Reference ALTA VIA WATER MAIN REPLACE	Terms 1% 10TH, NET 11TH,	Clerk SMC	Date 2/29/24	Time 9:45
-----------------------	---------	----------------------------	--	-----------------------------	--------------	-----------------	--------------

Sold To
 * ANDERSON PACIFIC ENGINEERING
 1370 NORMAN AVE.
 SANTA CLARA, CA 95054
 (408) 970-9900

Ship To

DOC# 629297/5

 * INVOICE *

 SLSPR: 00 DEFAULT
 TAX : 500 SALES TAX: S CRUZ COU

SHIPPED	ORDERED	UM	SKU	DESCRIPTION	UNITS	PRICE/PER	EXTENSION
12		BG	SAKECS	EROSION CONTR SANDBAG 50#	12	5.99 /BG	71.88 *
							71.88
							0.00
							71.88
							6.47
							78.35
** AMOUNT CHARGED TO STORE ACCOUNT **							
(GOMEZ, JOSE)							
							TAXABLE
							NON-TAXABLE
							SUBTOTAL
							TAX AMOUNT
							TOTAL AMOUNT

Agenda: 4.4.24
 Item: 10c

José Gomez

X
 Received By _____



Alta Via Pipeline Replacement Project – Contract Change Order 11 (Steel Plate Rental for Temporary Bridge)

04/04/2024

Change Order No. 11

Contract No. 21/22-16

To: Anderson Pacific Engineering Construction, Inc.

This Change Order No. 11 for the San Lorenzo Valley Water District’s Alta Via Pipeline Replacement Project encompasses the following changes to Contract No. 21/22-16:

1. An Extra Cost adjustment encompassing costs accrued for the rental of steel plates as part of the temporary bridge structure in place on Monan Way.
2. This \$6,415.20 includes expenses over 3 months (November 2023, December 2023, and January 2024).

Payment Adjustment at Agreed Lump Sum of \$6,415.20; Adjusted Contract Price is \$2,693,646.23.

By signing this change order all parties agree to the preceding changes to the plans, specifications, and contract documents.

Brian Frus, Interim General Manager
San Lorenzo Valley Water District

Date: _____

Michael P. Gossett, Project Manager
Anderson Pacific Engineering Construction, Inc.

Date: _____



February 28, 2024

San Lorenzo Valley Water District
13060 CA-9
Boulder Creek, CA 95006

Attn: Steve Yazalina, Sandis

Reference: **Alta Via Pipeline Replacement Project, Potential Change Order No. 11- Steel Plate Rental for Temporary Bridge.**

Mr. Yazalina:

APEC was directed to provide a temporary bridge to support undermining of Monan Way. APEC has not been directed to install the permanent fix for this area and has accumulated rental charges for the steel plates. Please note that APEC is not charging for rental of steel beams. This PCO includes Daily Extra Work Reports that covers rental costs for the steel plates from November 2024 through January 2024.

Steel Plate Rental Costs: \$6,415.20

TOTAL: \$6,415.20

If you have any questions, please do not hesitate to contact me.

Regards,

Michael P. Gossett

Michael P. Gossett
Project Manager
Anderson Pacific Engineering Construction, Inc.

1370 Norman Avenue
Santa Clara, CA 95054
Lic. No. 245215

Description of Work: Steel plate rental for temporary bridge- rental from November 2023 to January 2024.

EQUIP. NO.	EQUIPMENT	OT/Delay Factor	HOURS		HOURLY RATE	EXTENDED AMOUNTS	LABOR		HOURS	HOURLY RATE	EXTENDED AMOUNTS
			RT	OT			RT	OT			
0		1			\$ -	\$ -			RT	\$ 71.15	\$ -
					\$ -	\$ -			OT	-	\$ -
0		1			\$ -	\$ -			RT	\$ 71.15	\$ -
					\$ -	\$ -			OT	-	\$ -
0		1			\$ -	\$ -		0	RT	\$ -	\$ -
					\$ -	\$ -		0	OT	\$ -	\$ -
0		1			\$ -	\$ -		0	RT	\$ -	\$ -
					\$ -	\$ -		0	OT	\$ -	\$ -
0		1			\$ -	\$ -		0	RT	\$ -	\$ -
					\$ -	\$ -		0	OT	\$ -	\$ -
0		1			\$ -	\$ -		0	RT	\$ -	\$ -
					\$ -	\$ -		0	OT	\$ -	\$ -
0		1			\$ -	\$ -		0	RT	\$ -	\$ -
					\$ -	\$ -		0	OT	\$ -	\$ -
0		1			\$ -	\$ -		0	RT	\$ -	\$ -
					\$ -	\$ -		0	OT	\$ -	\$ -
0		1			\$ -	\$ -		0	RT	\$ -	\$ -
					\$ -	\$ -		0	OT	\$ -	\$ -
0		1			\$ -	\$ -		0	RT	\$ -	\$ -
					\$ -	\$ -		0	OT	\$ -	\$ -
0		1			\$ -	\$ -		0	RT	\$ -	\$ -
					\$ -	\$ -		0	OT	\$ -	\$ -
0		1			\$ -	\$ -		0	RT	\$ -	\$ -
					\$ -	\$ -		0	OT	\$ -	\$ -
MATERIAL and/or TRUCKING											
Description	No. Units	Unit Cost	Amount								
Rental	3.00 EA	\$1,008.00	\$3,024.00								
Rental	3.00 EA	\$936.00	\$2,808.00								
	1.00 LS		\$0.00								
	1.00 LS		\$0.00								
	1.00 LS		\$0.00								
WORK DONE BY SUBCONTRACTOR and/or SPECIALISTS											
Description	No. Units	Unit Cost	Amount								
	1.00 LS		\$0.00								
	1.00 LS		\$0.00								
	1.00 LS		\$0.00								
TOTAL COST OF EQUIPMENT, MATERIALS AND TRUCKING											
											\$ -
TOTAL COST OF SUBCONTRACTOR AND SPECIALISTS											
											\$ -
TOTAL COST OF LABOR											
											\$ 5,832.00
TOTAL THIS REPORT											
											\$ 6,415.20

10% MARK-UP ON LABOR COST
10% MARK-UP ON EQUIPMENT, MATERIALS AND TRUCKING COST
7% MARK-UP ON SUBCONTRACTOR AND SPECIALISTS COST

Remit To:

Security Shoring & Steel Plates Inc.
P O Box 1990
Watsonville, CA 95077
www.securityshoring.com

RECEIVED
DEC 07 2023
APEC

Invoice

Continued	Invoice#
Wed 12/6/2023	160621E

Customer #: 1007

Anderson Pacific Engineering Constructio
1370 Norman Avenue

Santa Clara, CA 95054

Job Descr: Prospect & Hwy 9

Job No: 2202

Date Out Tue 10/24/2023

Terms	Aging Date
net 30	Wed 12/6/2023

PAID HERE

PAID HERE

Ordered By: Andin 408 316-4835

Used at Address

Andin 408-316-4835
Prospect & Hwy 9
Boulder Creek, CA

Qty	Items	Disc%	Status	Billed To	Price
10	6 X 10 Steel Plate 168Hrs \$39.00 1week \$39.00 4weeks \$117.00		Billed To	Fri 11/24/2023 8:00AM	\$1,170.00

8 plates = \$ 936.00

Current On Account

Please pay from this invoice.

Rental and Sales:					CA:
\$1,170.00					\$0.00

Total Amount:	\$1,170.00	Total Paid	\$0.00	Total Due	\$1,170.00
----------------------	-------------------	-------------------	---------------	------------------	-------------------

831-728-7777

www.securityshoring.com

831-728-1219

Remit To:

Security Shoring & Steel Plates Inc.
 P O Box 1990
 Watsonville, CA 95077
 www.securityshoring.com

Invoice

Continued	Invoice#
Fri 12/22/2023	160621F

Customer #: 1007

Anderson Pacific Engineering Constructio
 1370 Norman Avenue
 Santa Clara, CA 95054

Job Descr: Prospect & Hwy 9

Job No: 2202
 Date Out Fri 11/24/2023

Terms	Aging Date
net 30	Fri 12/22/2023

Ordered By: Andin 408 316-4835

Used at Address

Andin 408-316-4835
 Prospect & Hwy 9
 Boulder Creek, CA

Qty	Items	Disc%	Status	Billed To	Price
10	6 X 10 Steel Plate 168Hrs \$39.00 1week \$39.00 4weeks \$117.00		Billed To	Sun 12/24/2023 8:00AM	\$1,170.00

8 plates = \$736⁰⁰

RECEIVED
 JAN 23 2024
 APEC

30+ Days aged

Please pay from this invoice.

Rental and Sales:					CA:
\$1,170.00					\$0.00
Total Amount:	\$1,170.00	Total Paid	\$0.00	Total Due	\$1,170.00

831-728-7777

www.securityshoring.com

831-728-1219

2202
[Handwritten signature]

Remit To:

Security Shoring & Steel Plates Inc.
P O Box 1990
Watsonville, CA 95077
www.securityshoring.com

Invoice

Continued	Invoice#
Mon 1/29/2024	160734F

Customer #: 1007

Anderson Pacific Engineering Constructio
1370 Norman Avenue
Santa Clara, CA 95054

Job Desc: ~~California St~~

Job No: ~~2009~~ *2202*

Date Out Wed 12/20/2023

Terms	Aging Date
net 30	Mon 1/29/2024

Ordered By: Andin 408 316-4835

Used at Address

California @ HWY9 ✓
Boulder Creek

Qty	Items	Disc%	Status	Billed To	Price
10	8 X 10 Steel Plate 168Hrs \$39.00 1week \$39.00 4weeks \$117.00		Billed To	Sat 1/20/2024 11:30AM	\$1,170.00

8 plates = 936

RECEIVED
JAN 30 2024
APEC

Current On Account
Please pay from this invoice.

Rental and Sales:					CA:
\$1,170.00					\$0.00
Total Amount:	\$1,170.00		Total Paid	\$0.00	Total Due
					\$1,170.00

831-728-7777

www.securityshoring.com

831-728-1219

Remit To:

Security Shoring & Steel Plates Inc.
 P O Box 1990
 Watsonville, CA 95077
 www.securityshoring.com

Invoice

Continued	Invoice#
Wed 12/ 6/2023	161158B

Customer #: 1007

Job Descr: Prospect & Hwy 9

Anderson Pacific Engineering Constructio
 1370 Norman Avenue
 Santa Clara, CA 95054

RECEIVED
 DEC 07 2023
 APEC

Job No: 2202

Date Out Wed 11/ 8/2023

Terms	Aging Date
net 30	Wed 12/ 6/2023

Sub Item

Sub Item

Ordered By: Andin 408 316-4835

Used at Address

Andin 408-316-4835
 Prospect & Hwy 9
 Boulder Creek, CA

Qty	Items	Disc%	Status	Billed To	Price
6	8 X 12 STEEL PLATE 1week \$56.00 +1week \$56.00 4weeks \$168.00		Billed To	Fri 12/ 8/2023 8:00AM	\$1,008.00

Current On Account

Please pay from this invoice.

Rental and Sales:					CA:
\$1,008.00					\$0.00
Total Amount:	\$1,008.00	Total Paid	\$0.00	Total Due	\$1,008.00

831-728-7777

www.securityshoring.com

831-728-1219

Remit To:

Agenda: 4.4.24

Item: 10c

2202

Invoice

Security Shoring & Steel Plates Inc.
 P O Box 1990
 Watsonville, CA 95077
 www.securityshoring.com

Continued	Invoice#
Fri 1/12/2024	161158C

Customer #: 1007

Job Descr: Prospect & Hwy 9

Anderson Pacific Engineering Constructio
 1370 Norman Avenue
 Santa Clara, CA 95054

Job No: 2202

Date Out Fri 12/ 8/2023

Terms	Aging Date
net 30	Fri 1/12/2024

Print Date

Print Here

Ordered By: Andin 408 316-4835

Used at Address

Andin 408-316-4835
 Prospect & Hwy 9
 Boulder Creek, CA

Qty	Items	Disc%	Status	Billed To	Price
6	8 X 12 STEEL PLATE 1week \$56.00 +1week \$56.00 4weeks \$168.00		Billed To	Mon 1/ 8/2024 8:00AM	\$1,008.00

RECEIVED
 01/16/2024
 APEC

Current On Account
 Please pay from this invoice.

Rental and Sales:					CA:
\$1,008.00					\$0.00
Total Amount:	\$1,008.00	Total Paid	\$0.00	Total Due	\$1,008.00

831-728-7777

www.securityshoring.com

831-728-1219

2202

Remit To

Security Shoring & Steel Plates Inc.
 P O Box 1990
 Watsonville, CA 95077
 www.securityshoring.com

Invoice

Continued	Invoice#
Sat 2/17/2024	161158D

Customer #: 1007

Anderson Pacific Engineering Constructio
 1370 Norman Avenue
 Santa Clara, CA 95054

Job Descr: Prospect & Hwy 9

Job No. 2202

Date Out Mon 1/ 8/2024

Terms	Aging Date
net 30	Sat 2/17/2024

Ordered By: Andin 408 316-4835

Used at Address

Andin 408-316-4835
 Prospect & Hwy 9
 Boulder Creek, CA

Qty	Items	Disc%	Status	Billed To	Price
6	8 X 12 STEEL PLATE 1week \$56.00 +1week \$56.00 4weeks \$168.00		Billed To	Thu 2/ 8/2024 8:00AM	\$1,008.00

RECEIVED
 FEB 20 2024
 APEC

Current On Account
 Please pay from this invoice.

Rental and Sales:					CA:
\$1,008.00					\$0.00
Total Amount:	\$1,008.00	Total Paid	\$0.00	Total Due	\$1,008.00

831-728-7777

www.securityshoring.com

831-728-1219

MEMO

DATE: April 4, 2024
TO: Board of Directors, San Lorenzo Valley Water District
FROM: Brian Frus, Interim General Manager
SUBJECT: Amended and Restated Agreement with Miller Maxfield, Inc.

WRITTEN BY: Carly Blanchard, Environmental Program Manager
PRESENTED BY: Carly Blanchard, Environmental Program Manager

STAFF RECOMMENDATION

It is recommended that the Board directs the Interim General Manager to enter into an amended and restated agreement with Miller Maxfield, Inc. to continue outreach services.

RECOMMENDED MOTION

The Board:

1. Directs the Interim General Manager to enter into an amended and restated agreement with Miller Maxfield, Inc. increasing the not-to-exceed amount by \$150,000 from \$55,255 to \$205,255 for outreach services for FY 24-26; and
2. Authorizes the Interim General Manager to execute extensions and/or non-substantive modifications to the Agreement, as necessary.

BACKGROUND

In June 2022 the San Lorenzo Valley Water District (District) released a Request for Qualifications (RFP) for a comprehensive outreach consultant.

The RFP closed in July 2022 and Miller Maxfield, Inc. (M2) was selected for contract award.

Since their contract award, M2 has worked with District staff to establish regular social media posts, press releases, monthly newsletters and special project outreach including system flushing, the consumer confidence report (CCR), capital improvement projects, hiring, and the Proposition 218 process. M2 has also worked with staff to improve the District's website and its accessibility. Their guidance has been instrumental in the District's increased transparency and public outreach.

Due to staff turnover, their contract expired without renewal in July 2023. Since expiration, the District has worked with them on a time and materials basis to continue their services for important projects.

District staff requested a proposal from M2 to continue outreach services for the remainder of 2024 through March of 2026 (Attachment A). Staff is recommending reinstating and renewing the agreement with M2 based on their selection less than two years ago in a Request for Proposal process along with the proposed scope of work to continue services and accompanying not-to-exceed amount.

PRIOR COMMITTEE ACTION

The Administrative Committee discussed the selection of an outreach consultant at its meetings on June 14, 2022, and August 9, 2022. At the August 2022 meeting, the Committee selected Miller Maxfield, Inc. and recommended to the Board of Directors to enter in an agreement with firm.

The Administrative Committee has also received updates at its March 2023, April 2023, and May 2023 meetings, as well as outreach updates on the Proposition 218 outreach at its January 2024 meeting.

FISCAL IMPACT

The estimated total increased cost for the scope of work contained in the Amended and Restated Professional Services Agreement is \$150,000. No budget amendment is proposed. Based on current year-to-date expenses, there is sufficient department budget to cover the proposed expense increase.

ENVIRONMENTAL IMPACT

None

ATTACHMENTS

Attachment A: Amended and Restated Agreement with Miller Maxfield, Inc. including Scope of Services for Contract Renewal

**AMENDED AND RESTATED PROFESSIONAL SERVICES AGREEMENT
BY AND BETWEEN
THE SAN LORENZO VALLEY WATER DISTRICT
AND
MILLER MAXFIELD, INC.**

THIS AMENDED AND RESTATED PROFESSIONAL SERVICES AGREEMENT (“Agreement”) is made and entered into this 4th day of April 2024, by and between the San Lorenzo Valley Water District, a California county water district (“District”), and Miller Maxfield, Inc., a California Corporation (“Professional”). District and Professional may herein be referred to individually as a “Party” and collectively as the “Parties.” There are no other parties to this Agreement.

RECITALS

A. District seeks to hire an independent contractor to perform professional services to assist District with Communications and Community Outreach Services (the “Project”).

B. Professional has submitted a proposal to District to provide such professional services. A description of the services Professional proposes to provide (“Services”) is attached hereto as **Exhibits A and B**: Scope of Services for Contract Renewal. District desires to retain Professional to perform the Services, subject to the terms and conditions set forth in this Agreement.

C. The parties have outlined the rates and method of payment to Professional for its performance of the Services under this Agreement (“Compensation Schedule”), which is attached hereto as **Exhibits A and C**.

NOW, THEREFORE, in consideration of the mutual promises and covenants set forth below, the Parties agree as follows:

AGREEMENT

Section 1. Recitals. The recitals set forth above (“Recitals”) are true and correct and are hereby incorporated into and made part of this Agreement by this reference. In the event of any inconsistency between the Recitals and Sections 1 through 33 of this Agreement, Section 1 through 33 shall prevail.

Section 2. Term. The term of this Agreement shall be deemed to have commenced on the 30th day of September 2022 (“Effective Date”), being the date of execution of the original agreement, found as **Exhibit D**. Professional shall provide the services commencing on the Effective Date and terminate on the 31st day of March 2026 (“Term”) unless the Term is extended or the Agreement is terminated earlier pursuant to this Agreement.

Section 3. Effective Date. This Amended and Restated Agreement shall only become effective once all the Parties have executed by signature below.

Section 4. Work.

4.1. Services. Subject to the terms and conditions set forth in this Agreement, Professional shall provide District the Services described in **Exhibits A and B**. Any request for Services not included in **Exhibit A** will be considered a request for additional or modified Services (“Modification” or “Modifications”). Professional shall not receive additional compensation for any Modification of the Services unless the Parties agree otherwise in a writing executed by both Parties.

4.2. District Requested Modification of Services. District may, by written order, authorize Modifications to the Services described in **Exhibits A and B**. If such Modifications cause an increase in the cost or time required for performance of Professional’s Services, the Parties shall enter into a written amendment to this Agreement to adjust the Services and the rates to be paid to Professional or Compensation Schedule described in **Exhibits A and C**. The Services, Completion Schedule, or Compensation Schedule shall not be revised unless District and Professional mutually agree to a written amendment to this Agreement reflecting such revisions, additional compensation, time for performance, or such other terms or conditions mutually agreed upon by the Parties.

4.3. Professional Requested Modification in Services. Professional shall not be compensated for work outside the Services described in this Agreement, unless, prior to the commencement of the work outside the Services:

(a) Professional provides District with written notice that specific work requested by District or required to complete the Project is outside the agreed upon Services. Such notice shall: (i) be supported by substantial evidence that the work is outside the Services; (ii) set forth the Professional’s proposed course of action for completing the work and a specific request for District to approve the Modification to the Services; (iii) set forth the Professional’s proposed revisions, if any, to the Completion Schedule; and (iv) set forth the Professional’s proposed revisions, if any, to the Compensation Schedule; and

(b) District agrees that the work requires a Modification;

(c) District approves all adjustments, if any, to the Completion Schedule and Compensation Schedule; and

(d) The Parties execute a written amendment to this Agreement describing any Modification, together with any adjustment in the Completion Schedule and Compensation Schedule for Professional’s work. Compensation for any additional Services shall not exceed the Compensation or Fee Schedule in **Exhibits A and C**.

{CW021899.2}

Section 5. Compensation.

5.1. Amount, Time, and Manner of Payment for Professional Services. District shall pay Professional according to the rates and timing set forth in the Compensation or Fee Schedule in **Exhibits A and C**. The total amount of compensation to be paid under this Agreement shall not exceed **two hundred and five thousand two hundred and fifty-five dollars (\$205,255)**. On each anniversary date of the Effective Date, Professional will be allowed to increase prices with thirty (30) days' written notice to District. Increases may not exceed increases in the San Francisco-Oakland Consumer Price Index for all urban consumers or percentage increases in Professional's published prices, whichever is lower. In all cases, District may cancel this Agreement if a requested price increase is not acceptable.

5.2. Payments. District shall make payments in the amount invoiced by Professional within thirty (30) calendar days of receiving such invoice. In the event that an amount of an invoice is in dispute, District shall inform Professional of the amount and basis for the dispute and may withhold the amount which is in dispute until the dispute has been resolved.

5.3. Invoices. Professional shall provide District with monthly invoices sufficiently evidencing Professional's expenses and completion of the Services. All invoices furnished to District by Professional shall be in a form approved by District. The payments specified shall be the only payments made to Professional for performance of the Services, including compensation for any Modification. Professional shall submit all billings for Services to District within forty-five (45) days of the performance of such Services. District shall issue payment according to District's customary procedures and practices for issuing payments to independent contractors.

Section 6. Notice to Proceed. Professional shall not commence the performance of the Services until it has been given notice by District ("Notice to Proceed").

Section 7. Time of Performance. Professional warrants that it will commence performance of the Services within 30 calendar days of the date the Notice to Proceed and shall conform to the Completion Schedule. The time of performance is a material term of this Agreement relied on by District in entering into this Agreement.

Section 8. District Assistance to Professional. Professional shall, at its sole cost and expense, furnish all facilities, equipment, materials, information, personnel, and administrative assistance which may be required to perform its obligations under this Agreement, unless otherwise specified in **Exhibit A** or this Agreement.

Section 9. Duties of District. In order to permit Professional to render the services required hereunder, District shall, at its expense and in a timely manner: (a) Provide such information as Professional may reasonably require to undertake or perform the Services; (b) Promptly review any and all documents and materials submitted to District by Professional in order to avoid unreasonable delays in Professional's performance of the Services; and (c) Promptly notify Professional of any fault or defect in the performance of Professional's services hereunder.

{CW021899.2}

Section 10. Time and Personnel Devoted to Services. Professional shall devote such time and personnel to the performance of this Agreement, as is necessary to perform the Services in compliance with the Completion Schedule, Compensation Schedule, and this Agreement.

Section 11. Performance by Qualified Personnel; No Subcontracting. Services under this Agreement shall be performed only by competent personnel under the supervision and direct employment of Professional. Professional will conform with District's reasonable requests regarding assignment of personnel, but all personnel, including those assigned at District's request, shall be supervised by Professional. Professional is prohibited from subcontracting this Agreement or any part of it unless such subcontracting is expressly approved by District in writing. Neither Party shall, on the basis of this Agreement, contract on behalf of, or in the name of the other Party. An agreement made in violation of this provision shall confer no rights on any Party and shall be null and void.

Section 12. Representations of Professional. District relies upon the following representations by Professional in entering into this Agreement:

12.1. Qualifications. Professional represents that it is qualified to perform the Services provided in **Exhibits A and B** and that it possesses the necessary licenses and permits required to perform the Services or will obtain such licenses or permits prior to the time such licenses or permits are required. Professional shall also ensure that all subcontractors are similarly licensed and qualified. Professional represents and warrants to District that Professional shall, at Professional's sole cost and expense, keep in effect or obtain at all times during the Term of this Agreement, any licenses, permits, and approvals which are legally required for Professional to practice Professional's profession at the time the Services are rendered.

12.2. Professional Performance. Professional represents that all Services under this Agreement shall be performed in a professional manner and shall conform to the customs and standards of practice observed on similar, successfully completed projects by specialists in the Services to be provided. Professional shall adhere to accepted professional standards as set forth by relevant professional associations and shall perform all Services required under this Agreement in a manner consistent with generally accepted professional customs, procedures, and standards for such Services. All work or products completed by Professional shall be completed using the best practices available for the profession. Professional agrees that, if a Service is not so performed, in addition to all of its obligations under this Agreement and at law, Professional shall re-perform or replace unsatisfactory Service at no additional expense to District.

12.3. No Waiver of Claims. The granting of any progress payment by District, or the receipt thereof by Professional, or any inspection, review, approval or oral statement by any representative of District, or state certification shall not, in any way, waive, limit, or replace any certification or approval procedures normally required or lessen the liability of Professional to re-perform or replace unsatisfactory Service, including, but not limited to, cases where the unsatisfactory character of such Service may not have been apparent or detected at the time of such payment, inspection, review or approval.

12.4. District's Remedies are Cumulative. Nothing in this Section shall constitute a waiver or limitation of any right or remedy, whether in equity or at law, which District or Professional may have under this Agreement or any applicable law. All rights and remedies of District, whether under this Agreement or applicable law, shall be cumulative.

12.5. No Conflict of Interest. Professional represents that no conflict of interest will be created under state or federal law by entering into or in carrying out this Agreement.

Section 13. Conformity with Law and Safety. Professional shall observe and comply with all applicable laws, ordinances, codes, regulations, and permits of governmental agencies, including federal, state, municipal and local governing bodies having jurisdiction over any or all of the scope of Services, including all provisions of the Occupational Safety and Health Act of 1979 as amended, all California Occupational Safety and Health Regulations, the California Building Code, the Americans with Disabilities Act, any copyright, patent, or trademark law, and all other applicable federal, state, municipal and local safety regulations, appropriate trade association safety standards, and appropriate equipment manufacturer instructions. All Services performed by Professional must be in accordance with these laws, ordinances, codes, and regulations, including the administrative policies and guidelines of District pertaining to the work. Professional's failure to comply with any laws, ordinances, codes, or regulations applicable to the performance of the Services hereunder shall constitute a breach of contract. In cases where standards conflict, the standard providing the highest degree of protection shall prevail.

If a death, serious personal injury, or substantial property damage occurs in connection with the performance of this Agreement, Professional shall immediately notify District Manager by telephone. If any accident occurs in connection with this Agreement, Professional shall promptly submit a written report to District, in such form as District may require. This report shall include the following information: (a) Name and address of the injured or deceased person(s); (b) Name and address of Professional's subcontractor, if any; (c) Name and address of Professional's liability insurance carrier; and (d) A detailed description of the accident, including whether any of District's equipment, tools or materials were involved.

If a release of a hazardous material, substance, or waste occurs in connection with the performance of this Agreement, Professional shall immediately notify District Manager.

Section 14. Contact by Professional with Project Owner or Project Applicant. Unless otherwise set forth in the Services, neither Professional nor Professional's subcontractors shall directly contact the owner of the property involved in the Project or any party who is the applicant for the Project ("Interested Party"), or an employee or contractor of an Interested Party, on any matter relating to the Project without the prior consent of District. In no event shall Professional take any instructions or directions from an Interested Party on any matter pertaining to the Professional's Services to be performed for District under this Agreement.

Section 15. Confidentiality. Professional understands and agrees that, in the performance of Services under this Agreement or in the contemplation thereof, Professional may have access to private or confidential information that may be owned or controlled by District and that such

information may contain proprietary or confidential details, the disclosure of which to third parties may be damaging to District (“Confidential Information”).

Professional shall not, either during or after the Term, disclose to any third party any Confidential Information without the prior written consent of District. If District gives Professional written authorization to make any such disclosure, Professional shall do so only within the limits and to the extent of that authorization. Professional may be directed or advised by the District’s General Counsel on various matters relating to the performance of the Services on the Project or on other matters pertaining to the Project and, in such event, Professional agrees that it will treat all communications between itself, its employees and its subcontractors as being communications which are within the attorney-client privilege.

Notwithstanding the foregoing, Professional may disclose Confidential Information required to be disclosed under law, provided that, prior to disclosure, Professional shall first give notice to District and make a reasonable effort to obtain a protective order requiring that District’s Confidential Information not be disclosed. This exception is limited to the extent disclosure is required under law.

Section 16. Ownership of Work Product. Any and all work, artwork, copy, posters, billboards, photographs, videotapes, audiotapes, systems designs, software, reports, designs, specifications, drawings, diagrams, surveys, source codes, professional or technical information or data, photographs, notes, letters, emails or any original works of authorship created by Professional or its subcontractors or subcontractors in connection with Services performed under this Agreement (“Products”) shall be works for hire as defined under Title 17 of the United States Code, and all copyrights in such works are the property of District. In the event it is ever determined that any Product created by Professional or its subcontractors, or subcontractors under this Agreement, are not works for hire under U.S. law, Professional hereby assigns all copyrights to such Products to District. With the prior written approval of District’s point of contact for the Project, Professional may retain and use copies of such Products for reference and as documentation of its experience and capabilities.

All Products shall become the property of District irrespective of where located or stored, and Professional agrees to deliver all such documents and information to District, without charge and in whatever form it exists, on the completion of the Professional’s Services hereunder. Professional shall have no ownership interest in such Products.

All work product of Professional under this Agreement, including written information which District will cause to be distributed for either internal or public circulation, including both preliminary and final drafts, shall be delivered to District in both printed and electronic form, or as may be specified in **Exhibits A and B**.

Upon the conclusion of the Term or in the event of Termination, Professional agrees, at its expense and in a timely manner, to return to District all documents, drawings, photographs and other written or graphic material, however produced, that it received from District, its contractors, or agents, in connection with the performance of its Services under this Agreement. All materials shall be returned in the same condition as received.

{CW021899.2}

Section 17. Assignment Prohibited. No Party to this Agreement may assign any right or obligation pursuant to this Agreement. Any attempt or purported assignment of any right or obligation pursuant to this Agreement shall be void and of no effect.

Section 18. Excusable Delays; Notice to Other Party of Delay. Professional shall not be in breach of this Agreement in the event that performance of Services is temporarily interrupted or discontinued due to a “Force Majeure” event which is defined as: riots, wars, sabotage, civil disturbances, insurrections, explosion, natural disasters such as floods, earthquakes, landslides, fires, strikes, lockouts and other labor disturbances or other catastrophic events, which are beyond the reasonable control of Professional. Force Majeure does not include: (a) Professional’s financial inability to perform; (b) Professional’s failure to obtain any necessary permits or licenses from other governmental agencies; or (c) Professional’s failure to obtain the right to use the facilities of any public utility where such failure is due solely to the acts or omissions of the Professional.

Section 19. Suspension of Services by District. District reserves the right to suspend Professional's Services under this Agreement when District determines that it is necessary to do so. When possible, District shall give Professional notice of such suspension and Professional shall, upon receipt of said notice, suspend all Services except any Services, the completion of which is authorized by the notice given by District. If the Services are suspended by District for more than sixty (60) consecutive days, for reasons other than the fault of the Professional, the Professional shall be compensated for Services performed prior to notice of such suspension. When the Project is resumed, the Professional's compensation shall be equitably adjusted by District to provide for expenses incurred by the interruption of the Services. In this regard, Professional shall furnish to District such financial information that, in the judgment of the District Manager, is necessary to determine the reasonable value of the Services rendered by Professional during the period when Services were suspended.

If the Parties are unable to agree upon the amount of extra compensation which is due to Professional within thirty (30) days of Professional resuming Services, the amount of such additional compensation, if any, that is required to appropriately compensate the Professional for its expenses incurred by the interruption of Services may, upon the request of either Party, be determined by arbitration conducted in accordance with the “Arbitration of Disputes” section of this Agreement. Such arbitration shall be commenced by the Professional no later than sixty (60) calendar days following the event which entitles the Parties to pursue arbitration unless the Parties agree in writing to an extended time period for commencement of arbitration. Unless otherwise agreed in writing, all Parties shall carry on the Services and perform their duties during any arbitration proceedings, and District shall continue to make payments for the Services in progress as required by this Agreement.

Section 20. Termination of Work by District for Its Convenience. District shall have the right to terminate this Agreement at any time for its convenience by giving notice of such termination to Professional (“Termination”). In the event District shall give such notice of termination, Professional shall cease rendering Services upon receipt of said notice given as required in this Agreement. If District terminates this Agreement:

(a) Professional shall deliver copies of all Products prepared by it pursuant to this Agreement.

(b) If District terminates this Agreement for convenience before District issues the Notice to Proceed to Professional or before Professional commences any Services hereunder, whichever last occurs, District shall not be obligated to make any payment to Professional. If District terminates this Agreement after District has issued the Notice to Proceed to Professional and after Professional has commenced performance under this Agreement, District shall pay Professional the reasonable value of the Services rendered by Professional pursuant to this Agreement prior to termination of this Agreement. District shall not in any manner be liable for Professional's actual or projected lost profits had Professional completed the Services. Professional shall furnish to District such financial information that, in the judgment of the District Manager, is necessary to determine the reasonable value of the Services rendered by Professional prior to termination. In the event of a dispute as to the reasonable value of the Services rendered by Professional prior to termination and the Parties are unable to agree upon said amount within sixty (60) calendar days following the date of the notice of termination by District, such dispute may, upon the request of either Party, be resolved by arbitration conducted in accordance with the "Arbitration of Disputes" section of this Agreement.

(c) Except as provided in this Agreement, in no event shall District be liable for costs incurred by or on behalf of Professional after the date of the notice of termination.

(d) Notwithstanding this Section, this Agreement may be terminated by District for cause based on the loss or suspension of any licenses, permits or registrations required for the continued provision of the Services, or Professional's malfeasance. Termination of the Agreement for cause as set forth in this Section shall relieve District from compensating Professional.

Section 21. Assurance of Performance. If, at any time, District believes Professional may not be adequately performing its obligations under this Agreement or may fail to complete the Services as required by this Agreement, District may submit a written request to Professional for written assurances of performance and a plan to correct observed deficiencies in Professional's performance. Failure to provide written assurances subsequent to such written request, constitutes grounds to declare a breach under this Agreement.

Section 22. Cancellation for Breach by Either Party. Should either Party fail to substantially perform its obligations in accordance with the provisions of this Agreement, the other Party shall thereupon have the right to cancel the Agreement by giving written notice and specifying the effective date of such cancellation. If District cancels this Agreement for breach and it is subsequently determined that Professional did not fail to substantially perform its obligations in accordance with this Agreement, then cancellation for breach by District shall be deemed, and treated, as termination for convenience.

Neither Party waives the right to recover damages against the other for breach of this Agreement, including any amount necessary to compensate District for all detriment proximately caused by Professional's failure to perform its obligations hereunder or which in the ordinary

course of things would be likely to result therefrom. District reserves the right to offset such damages against any payments owed to Professional.

District shall not in any manner be liable for Professional's actual or projected lost profits had Professional completed the Services required by this Agreement.

Section 23. Arbitration of Disputes. All claims, disputes, and other matters in question between District and Professional arising out of or relating to this Agreement or the breach thereof, including claims of Professional for extra compensation for Services related to the Project, shall be decided by arbitration before a single arbitrator in accordance with the provisions of Sections 1281 to 1284.2 of the California Code of Civil Procedure (the "Arbitration Laws") unless the Parties mutually agree otherwise. The provisions of Section 1283.05 of the Arbitration Laws apply to any arbitration proceeding except as otherwise provided in this Agreement. The arbitrator shall have authority to decide all issues between the Parties including, but not limited to, claims for extras, delay, and liquidated damages, if any, provided for in this Agreement, matters involving defects in the work product of the Professional, rights to payment, and whether the necessary procedures for arbitration have been followed. The award rendered by the arbitrator shall be final, and judgment may be entered upon it in accordance with applicable law in any court having jurisdiction thereof.

Notice of the demand for arbitration shall be filed in writing with the other Party. The demand for arbitration shall be made within a reasonable time after the claim, dispute, or other matter in question has arisen, and in no event shall it be made after the date when institution of legal or equitable proceedings based on such claim, dispute, or other matter in question would be barred by the applicable statute of limitation.

The Parties shall jointly appoint an arbitrator within fifteen (15) calendar days of the date of giving of the notice of the demand for arbitration. If the Parties are unable to jointly agree upon the appointment of an arbitrator within said fifteen (15) calendar day period, and do not agree in writing to extend said period for a fixed period, then either Party may seek to have the arbitrator appointed by the Superior Court of Santa Cruz County in accordance with the Arbitration Laws.

If any proceeding is brought to contest the right to arbitrate and it is determined that such right exists, the losing Party shall pay all costs and attorneys' fees incurred by the prevailing party.

In addition to the other rules of law which may be applicable to any arbitration hereunder, the following shall apply:

(a) Promptly upon the filing of the arbitration, each Party shall be required to set forth in writing and to serve upon each other Party a detailed statement of its contentions of fact and law.

(b) All parties to the arbitration shall be entitled to the discovery procedures as provided in Section 1283.05 of the California Code of Civil Procedure.

(c) The arbitration shall be commenced and conducted as expeditiously as possible consistent with affording reasonable discovery as provided herein.

(d) These additional rules shall be implemented and applied by the arbitrator.

The costs of arbitration shall be borne by the Parties as determined by the arbitrator, but each Party shall bear its own attorney's fees associated with the dispute with the other Party and to the arbitration.

Section 24. Insurance Coverage. During the Term, the Professional shall maintain in full force and effect policies of insurance set forth herein, which shall be placed with insurers with a current A M Best's rating of no less than A VII and will provide District with written proof of said insurance. Professional shall maintain coverage as follows:

24.1. General Liability. Professional shall carry general liability insurance in the amount of Two Million Dollars (\$2,000,000.00) per occurrence for bodily injury, personal injury, and property damage. If commercial general liability insurance or another form with a general aggregate limit is used, either the general aggregate limit shall apply separately to this Project or the general aggregate shall be Two Million Dollars (\$2,000,000.00).

24.2. Workers' Compensation Insurance and Employer's Liability. Professional shall carry workers' compensation insurance as required by the State of California under the Labor Code. Professional shall also carry employer's liability insurance in the amount of One Million Dollars (\$1,000,000.00) per accident, with a One Million Dollar (\$1,000,000.00) policy limit for bodily injury by disease, and a One Million Dollar (\$1,000,000.00) limit for each employee's bodily injury by disease.

24.3. Errors and Omissions Liability. Professional shall carry errors and omissions liability insurance in the amount of no less than Two Million Dollars (\$2,000,000.00) per occurrence or greater if appropriate for the Professional's profession. Any deductibles or self-insured retentions must be declared to and approved by District. At the option of the District, either the insurer shall reduce or eliminate such deductibles or self-insured retentions with respect to the District, elected and appointed councils, commissions, directors, officers, employees, agents, and representatives ("District's Agents"); or the Professional shall provide a financial guarantee satisfactory to the District guaranteeing payment of losses and related investigations, claims administration and defense expenses.

24.4. Commercial Automobile Liability. Professional shall carry commercial automobile liability insurance in the amount of One Million Dollars (\$1,000,000) or greater per occurrence for owned, leased, hired, and borrowed automobiles.

24.5. Waiver of Subrogation. With the exception of errors and omissions liability insurance, Professional hereby agrees to waive subrogation which any insurer of Professional may acquire from Professional by virtue of the payment of any loss. The commercial general liability policy and workers' compensation policy shall be endorsed to contain a waiver of subrogation in favor of District for all work performed by Professional, its agents, employees, independent

{CW021899.2}

contractors, and subcontractors. Professional agrees to obtain any endorsement that may be necessary to affect this waiver of subrogation.

Section 25. Additional Insurance Requirements. Within five (5) days of the Effective Date, Professional shall provide District with certificates of insurance for all of the policies required under this Agreement (“Certificates”), excluding the required workers’ compensation insurance. Such Certificates shall be kept current for the Term of the Agreement and Professional shall be responsible for providing updated copies and notifying District if a policy is cancelled, suspended, reduced, or voided. With the exception of the workers’ compensation insurance, all of the insurance policies required in this Agreement shall:

(a) Provide that the policy will not be cancelled, allowed to expire, or materially reduced in coverage without at least thirty (30) days’ prior written notice to District of such cancellation, expiration, or reduction and each policy shall be endorsed to state such;

(b) Name District, and District’s Agents as additional insureds with respect to liability arising out of Services, work, or operations performed by or on behalf of Professional;

(c) Cover products and completed operations of Professional, premises owned, occupied, or used by the Professional, or automobiles owned, leased, or hired or borrowed by the Professional; contain no special limitations on the scope of protection afforded to District;

(d) Be primary with respect to any insurance or self-insurance programs covering District or District’s Agents and any insurance or self-insurance maintained by District or District’s Agents shall be in excess of Professional’s insurance and shall not contribute to it;

(e) Contain standard separation of insured provisions; and

(f) State that any failure to comply with reporting or other provisions of the policy including breaches of warranties shall not affect the coverage provided to District.

Section 26. Indemnification by Professional. To the fullest extent permitted by law (including, without limitation, California Civil Code sections 2782 and 2782.8), Professional shall defend with legal counsel reasonably acceptable to District, indemnify and hold harmless District and District’s Agents from and against any and all claims, loss, cost, damage, injury (including, without limitation, injury to or death of an employee of Professional or its subcontractors), expense and liability of every kind, nature and description that arise out of, pertain to, or relate to acts or omissions of Professional, or any direct or indirect subcontractor, employee, contractor, representative or agent of Professional, or anyone that Professional controls (collectively “Liabilities”). Such obligations to defend, hold harmless, and indemnify District and District’s Agents shall not apply to the extent that such Liabilities are caused in whole by the sole negligence, active negligence, or willful misconduct of District and District’s Agents, but shall apply to all other Liabilities. With respect to third party claims against the Professional, the Professional waives any and all rights of any type of express or implied indemnity against District and District’s Agents.

{CW021899.2}

Section 27. Liability of District. Notwithstanding any other provision of this Agreement, in no event shall District be liable, regardless of whether any claim is based on contract or tort, for any special, consequential, indirect, or incidental damages, including, but not limited to, lost profits or revenue, arising out of or in connection with this Agreement or the Services performed in connection with this Agreement.

Section 28. Independent Contractor. At all times during the Term, Professional shall be deemed to be an independent contractor and shall be wholly responsible for the manner in which Professional performs the Services required under this Agreement. Professional shall be liable for its acts and omissions and those of its employees, contractors, subcontractors, representatives, volunteers, and its agents. Nothing contained herein shall be construed as creating an employment, agency, or partnership relationship between District and Professional. District shall have the right to control Professional only insofar as the result of Professional's Services rendered pursuant to this Agreement; however, District shall not have the right to control the means by which Professional accomplishes Services rendered pursuant to this Agreement.

Section 29. Professional Not Agent. Except as District may specify in writing, Professional shall have no authority, express or implied, to act on behalf of District in any capacity whatsoever as an agent. Professional shall have no authority, express or implied, pursuant to this Agreement to bind District to any obligation whatsoever.

Section 30. Payment of Taxes and Other Expenses. Payment of any taxes, including California sales and use taxes, levied upon this Agreement, the transaction, or the Services or goods delivered pursuant hereto, shall be the obligation of Professional.

Section 31. Notices. Any notice or communication required hereunder between District and Professional must be in writing, and may be given either personally, by registered or certified mail (return receipt requested), or by Federal Express, UPS or other similar couriers providing overnight delivery. If personally delivered, a notice shall be deemed to have been given when delivered to the Party to whom it is addressed. Notices given by registered or certified mail shall be deemed to have been given and received on the first to occur of (a) actual receipt by any of the addressees designated below as the party to whom notices are to be sent, (b) on the date delivered as shown on a receipt issued by the courier, or (c) five (5) days after a registered or certified letter containing such notice, properly addressed, with postage prepaid, is deposited in the United States mail. If given by Federal Express or similar courier, a notice or communication shall be deemed to have been given and received on the date delivered as shown on a receipt issued by the courier. Any Party hereto may at any time, by giving ten (10) days written notice to the other Party hereto, designate any other address in substitution of the address to which such notice or communication shall be given. Such notices or communications shall be given to the Parties at the addresses in this paragraph set forth below:

If to District:

**San Lorenzo Valley Water District
Attn: Brian Frus, General Manager
13060 Highway 9
Boulder Creek, CA 95006**

{CW021899.2}

With courtesy copies to:

**White Brenner LLP
Attn: Barbara A. Brenner
1414 K Street, 3rd Floor
Sacramento, CA 95814**

If to Professional:

**Bill Maxfield, Principal
133 Mission Street, Suite 101
Santa Cruz, CA 95060
Phone: 831-227-6469
Email: bill@millermxfield.com**

Section 32. Exhibits. All “Exhibits” referred to below or attached to herein are by this reference incorporated into this Agreement:

<u>Exhibit Designation</u>	<u>Exhibit Title</u>
Exhibit A:	Scope of Services for Contract Renewal
Exhibit B	Response to RFP for Communications and Outreach Services
Exhibit C	Proposed Total Professional Fee and Fee Schedule
Exhibit D	Agreement for Professional Services, September 30, 2022

Section 33. General Provisions.

a. Modification. No alteration, modification, or termination of this Agreement shall be valid unless made in writing and executed by all Parties.

b. Waiver. No covenant, term, or condition or the breach thereof shall be deemed waived, except by written consent of the Party against whom the waiver is claimed, and any waiver of the breach of any covenant, term, or condition shall not be deemed to be a waiver of any preceding or succeeding breach of the same or any other covenant, term, or condition.

c. Assignment. No Party shall assign, transfer, or otherwise dispose of this Agreement in whole or in part to any individual, firm, or corporation without the prior written consent of the other Party. Subject to the forgoing provisions, this Agreement shall be binding upon, and inure to the benefit of, the respective successors and assigns of the Parties.

d. Governing Law. This Agreement shall be governed by and construed in accordance with the laws of the state of California.

e. Venue. Venue for all legal proceedings shall be in the Superior Court of California for the County of Santa Cruz.

f. Counterparts. This Agreement may be executed in two or more counterparts, each of which shall constitute an original and all of which shall be deemed a single agreement.

{CW021899.2}

g. Severability. If this Agreement in its entirety is determined by a court to be invalid or unenforceable, this Agreement shall automatically terminate as of the date of final entry of judgment. If any provision of this Agreement shall be determined by a court to be invalid and unenforceable, or if any provision of this Agreement is rendered invalid or unenforceable according to the terms of any federal or state statute, which becomes effective after the Effective Date of this Agreement, the remaining provisions shall continue in full force and effect and shall be construed to give effect to the intent of this Agreement.

h. Audit. District shall have access at all reasonable times to all reports, contract records, contract documents, contract files, and personnel necessary to audit and verify Professional's charges to District under this Agreement.

i. Entire Agreement. This Agreement sets forth the entire understanding between the Parties as to the subject matter of this Agreement and merges all prior discussions, negotiations, proposal letters or other promises, whether oral or in writing.

j. Supersedes Prior Agreement. It is the intention of the Parties hereto that this Agreement shall supersede any prior agreements, discussions, commitments, or representations, whether written, electronic or oral, between the Parties with respect to the subject matter of this Agreement.

k. Headings Not Controlling. Headings used in this Agreement are for reference purposes only and shall not be considered in construing this Agreement.

l. Successors and Assigns. All representations, covenants, and warranties specifically set forth in this Agreement, by or on behalf of, or for the benefit of, any or all of the Parties hereto, shall be binding upon and inure to the benefit of such Party, its successors and assigns.

m. Interpretation. As used herein, any gender includes each other gender, the singular includes the plural and vice versa.

n. Mandatory and Permissive. "Shall" and "will" and "agrees" are mandatory. "May" and "can" are permissive.

o. Attorney's Fees and Costs. If any action at law or in equity not resolved pursuant to the "Arbitration of Disputes" section of this Agreement, including action for declaratory relief, is brought to enforce or interpret provisions of this Agreement, the prevailing Party shall be entitled to reasonable attorney's fees and costs, which may be set by the court in the same action or in a separate action brought for that purpose, in addition to any other relief to which such Party may be entitled.

p. Successors and Assigns. All representations, covenants, and warranties specifically set forth in this Agreement, by or on behalf of, or for the benefit of, any or all of the Parties hereto, shall be binding upon and inure to the benefit of such Party, its successors and assigns.

{CW021899.2}

q. Time is of the Essence. Time is of the essence in this Agreement for each covenant and term of a condition herein.

[Signatures on Following Page]

IN WITNESS WHEREOF, the Parties have executed this Agreement as of the last day and date below written.

DISTRICT:

SAN LORENZO VALLEY WATER
DISTRICT, a California County Water District

By: _____
Brian Frus, Interim General Manager

Date: _____

Approved as to Form:

Barbara A. Brenner, General Counsel

PROFESSIONAL:

Miller Maxfield Inc., a California Corporation

By: _____

Name: _____

Date: _____

EXHIBIT A

Scope of Services for Contract Renewal

Exhibit A



Miller Maxfield, Inc.
Strategic Communications
& Public Affairs

Scope of Services for Contract Renewal **San Lorenzo Valley Water District**

OVERVIEW

The San Lorenzo Valley Water District (SLVWD) is in need of communications and outreach support through ongoing monthly activities and special projects

SCOPE

Working in close collaboration with the SLVWD staff, Miller Maxfield will continue to deliver services including:

- **Messaging:**
 - Develop key messages about District projects and programs as needed
 - Writing/editing of fact sheets and FAQs
- **Outreach**
 - Write and distribute press releases, with goal of one per month
 - Secure media coverage
 - Monthly social media content development and execution
 - Content, layout and execution for monthly email newsletters and other eblasts
- **Website**
 - Update website content as needed
 - Conduct quarterly website reviews to keep material current
- **Graphic design, collateral & photography**
 - Design outreach materials as appropriate
 - Capture photos of District programs and projects; maintain photo library
 - Video and drone photography management as needed
- **Advertising**
 - Execute advertising as needed — determine advertising strategies, design ads and coordinate submissions
- **Strategic counsel and special projects support**
 - Collaborate with District staff to develop and executive reactive and proactive outreach strategies related to special projects as needed

DURATION

April 1, 2024-March 31, 2026

BUDGET/FEES

Compensation not to exceed \$150,000.00 for the duration of the contract without approval from client. Miller Maxfield will bill monthly, based only on hours used for services. Printing, postage and advertising costs not included. Fee schedule: \$125/hr – graphic design; \$150/hr – account management; \$175/hr - principals

EXHIBIT B

Response to RFP for Communications and Outreach Services

Response to San Lorenzo Valley Water District



RFP for

Communications & Outreach Services

Table of Contents

Prepared by Miller Maxfield, Inc.
Strategic Communications & Public Affairs
133 Mission Street, Suite 101
Santa Cruz, CA 95060
(831) 227-6469



Miller Maxfield, Inc.
Strategic Communications
& Public Affairs

Executive Summary	02
Identification of Prime & Sub Consultants	04
Organization and Experience of the Team	05
Experience and Past Performance	10
Firm's Local Experience	15
Creative Alternatives & Exceptions to this RFP	16
Attachments	17-24

Executive Summary

Miller Maxfield, Inc. is a locally owned, award-winning strategic communications and public affairs firm that was established in 2002. Delivering a full array of services, we help our public sector, nonprofit and small business clients develop and execute dynamic, engaging communications strategies that have measurable impacts.

Our work is defined by our ability to effectively tell our clients' stories, utilizing skills and strategies that are tailored to each client and project. Miller Maxfield's services include strategic analysis, messaging, stakeholder and community engagement, branding and graphic design, social media strategy, digital marketing, media relations, event production and promotion, website development and maintenance, video production and crisis communications.

For our clients, we provide essential understanding and insights into the most effective strategies and tactics required to educate target audiences, earn support, and prevent and/or solve misunderstandings related to important public sector projects.

Miller Maxfield has extensive knowledge of Santa Cruz County's diverse communities, and their hyper-local characteristics and unique cultures. Our experienced and determined team combines that knowledge with professional execution of proven, creative strategies that help build public trust and lead to successful outcomes.

Miller Maxfield's Unique Qualifications to Represent SLVWD

As the communications firm of record for the San Lorenzo Valley Water District (SLVWD) from 2013-2018, as well as Santa Margarita Groundwater Agency (SMGWA) from 2018-2022, Miller Maxfield is well positioned to once again serve SLVWD to meet its communications needs and goals.

Miller Maxfield's experience with SLVWD and SMGWA is substantially augmented by our current and past work with a wide variety of organizations that serve the San Lorenzo Valley and the broader region. Covering a wide range of sectors and interests, such as parks, transportation, human services and business/economy, a few of those organizations include Santa Cruz Community Health (which recently opened its new clinic in Ben Lomond), Roaring Camp Railroads, METRO, Friends of Santa Cruz State Parks (which is partnering with State Parks to reopen and rebuild Big Basin), Central Coast Community Energy, and Housing for Health (the County department dedicated to addressing homelessness via programs such as Project Homekey, which recently provided funds for the Veterans Village project).

Miller Maxfield understands water agencies. In addition to our experience with SLVWD and SMGWA, our depth of experience includes service for Pajaro Valley Water Management Agency, Santa Cruz Water Department, Scotts Valley Water District, Mid-County Groundwater Agency, Marina Coast Water District and Salinas Valley Basin Groundwater Sustainability Agency.

Our specific experience with water agencies includes knowledge of water supply systems, capital improvement projects, the Proposition 218 process, community engagement and events, drought and climate change response campaigns, customer service programs, employee recruiting and crisis communications, as well as routine communications support, such as social media strategy and content, website maintenance, email newsletters, direct mail, bill inserts, advertising, signage and more.

Executive Summary

With respect to SLVWD, Miller Maxfield understands the important and unique balancing act continuously faced by the District, some examples of which include:

- Recovery from the CZU Fire - resilience, sustainability and available funding.
- Sources of water – streams and wells, influenced by annual rainfall patterns and sustainability goals.
- Conveyance – investment in pipes, pumps, tanks and inerties.
- Rates – the need to show deep respect for the high cost of living in our area that heavily impacts ratepayers and also the high cost of maintaining a reliable and resilient water system.
- The culture and politics that make SLV a special place.

The San Lorenzo Valley, taken as a whole, is a community that holds fierce pride in the need to protect the beauty and culture of living in the Santa Cruz Mountains. Living in the Valley also means being prepared for anything, especially natural disasters. The people of SLV have a long-standing and widely known reputation for taking care of each other – in both the simplest and most heroic ways, no matter what.

But understanding life in the Valley also means understanding the individual communities that comprise SLV. There are situations when the needs of Felton or Ben Lomond may not be the same as Brookdale or Boulder Creek, which are different still from Lompico or Zayante. In addition, SLVWD's service to areas in and adjacent to the City of Scotts Valley have their own unique set of needs.

SLVWD holds a critical role not only because of its management of the water system and watershed, but also because it is a public agency that serves essentially the entire unincorporated Valley (and a bit beyond) AND is also headquartered in the Valley, managed by an elected board that is accountable to local voters.

Miller Maxfield recognizes at an intuitive level how important it is to understand the Valley and the way it relates to SLVWD. Respect for ratepayers and the Valley way of life is foundational to successfully supporting the District's communications and outreach efforts. Miller Maxfield is experienced, qualified and well positioned to provide all services required to meet SLVWD's goals.

Identification of Prime Consultant

Miller Maxfield, Inc.
133 Mission Street, Suite 101
Santa Cruz, CA 95060

Legal entity: Corporation
Contact: Bill Maxfield, Principal
133 Mission Street, Suite 101
Santa Cruz, CA 95060
Phone: 831-227-6469
Email: bill@millermxfield.com

Miller Maxfield Team

The Miller Maxfield team includes:

Principals: 2
Senior Director: 1
Community Engagement Managers: 2
Creative Services Manager: 1
Graphic Designers: 2
Content Creator: 1
Special Projects/Office Manager: 1

Total number of team members: 10

Identification of Sub Consultant

Colleen Valles, Technical Writer
522 Flora Lane
Scotts Valley, CA 95066

Legal entity: Sole Proprietor
Contact: Colleen Valles
522 Flora Lane
Scotts Valley, CA 95066
Phone: 831-524-6765
Email: colleen@colleenvalles.com

Organization and Experience of the Team

The Miller Maxfield team assigned to SLVWD will consist of Bill Maxfield (Principal), Jennifer Murray (Senior Director), Tiffany Martinez (Community Engagement Manager), Natasha Del Rio (Creative Services Manager) and Colleen Valles (Technical Writer).

Jennifer Murray will serve as Team Manager. In this role, Jennifer will drive strategy development, ensure reporting and budgeting goals are met and provide quality control. Jennifer brings expansive experience in client services, including nearly nine years at Miller Maxfield, five of which included service to SLVWD. Jennifer's specific experience includes developing and executing outreach plans for many water agencies. Her experience with water agencies, has included management of every aspect of community outreach, including media outreach, writing, community meetings and workshops, collateral materials creation and production, crisis communications, social media strategy, website development and more.

Tiffany Martinez will serve as day-to-day contact, and will be responsible for generating content and ensuring all activities and deadlines are met. Colleen Valles will provide technical writing services. Natasha Del Rio will hold primary responsibility for all graphic design and printed production services. Bill Maxfield will provide oversight and strategic input, as well as ensure accountability. Please see below for Miller Maxfield's organization chart and team resumes.

In addition to day-to-day communication SLVWD will have with Tiffany, Jennifer and Bill will be available for direct contact with the SLVWD team as needed for scheduled and unscheduled meetings.

Most members of the Miller Maxfield team have worked together for numerous clients, especially on work related to the water industry. Current/recent examples include Santa Margarita Groundwater Agency, Pajaro Valley Water, Scotts Valley Water District, Santa Cruz Water Department and Salinas Valley Basin Groundwater Agency. Colleen Valles will join the team in support of SLVWD, augmenting Miller Maxfield's capacity to distill and explain complex water concepts and policies by leveraging her experience in the industry and background as a journalist.

The Miller Maxfield team approach will be rooted in our core values of accessibility, responsiveness and a high level of collaboration among members of the Miller Maxfield team, as well as with the SLVWD team. The Miller Maxfield team will operate through a hybrid office-home work plan, with time in the office anticipated to be at least 50% of the time. The team will adapt to SLVWD's preferred methods of communication, anticipating some combination of email, text, phone, Zoom and in-person communication.

Miller Maxfield anticipates there will be routine communication with the SLVWD team through regularly scheduled meetings to review progress toward specific outreach plans. Regular meetings of the Admin Committee and marketing team (to be attended by at least two members of the Miller Maxfield team), will undoubtedly be combined with frequent email, etc., as well as visits to the District offices and field operations, which could occur with some spontaneity depending on circumstances. The Miller Maxfield team is prepared to embrace this model in collaboration with the SLVWD team.

12-Month Planning Schedule

Miller Maxfield proposes a two-phase approach to delivery of a 12-month planning schedule. Phase 1 will focus on planning and Phase 2 will focus on execution of core strategies. It is anticipated there may be overlap between the two phases.

Throughout both the planning and execution phases, Miller Maxfield will provide all strategic development and project management required, attend regular meetings with the SLVWD team and will monitor monthly tasks to ensure strategies are on track and delivered within the approved budget. Miller Maxfield will also provide a monthly written report of activities and outcomes.

Phase 1: Planning August – September, 2022

The planning phase will begin with communication and collaboration with SLVWD's executive and communications team members to review current activities and messaging, as well as review and confirm key SLVWD projects and goals for the 12-month period. This due diligence will enable Miller Maxfield to identify opportunities and challenges for outreach and marketing activities and timelines as we proceed through the planning phase.

From these initial meetings and research, Miller Maxfield will create an actionable outreach plan, including specific strategies and tasks for community events/workshop concepts. The plan will also include details related to roles for Miller Maxfield and SLVWD, responsibilities and timing.

Phase 2: Execution October 2022 – July 2023

Miller Maxfield will transition from the planning mode into execution of the outreach plan, which is anticipated to include a mix of ongoing monthly activities (social media, etc.) and project-specific activities such as community events/workshops and related collateral materials.

We anticipate we will recommend a series of community meetings (target of three) taking place November, January and February. However, the actual number of workshops and timing of workshops is dependent on SLVWD goals and relevant milestones related to funding, etc.

Some activities may cross over between ongoing monthly activities and project-specific work, such as media relations. For example, media outreach (including press releases, etc.) and media tours could be timed to be integrated with community events/workshops.

Organization Chart

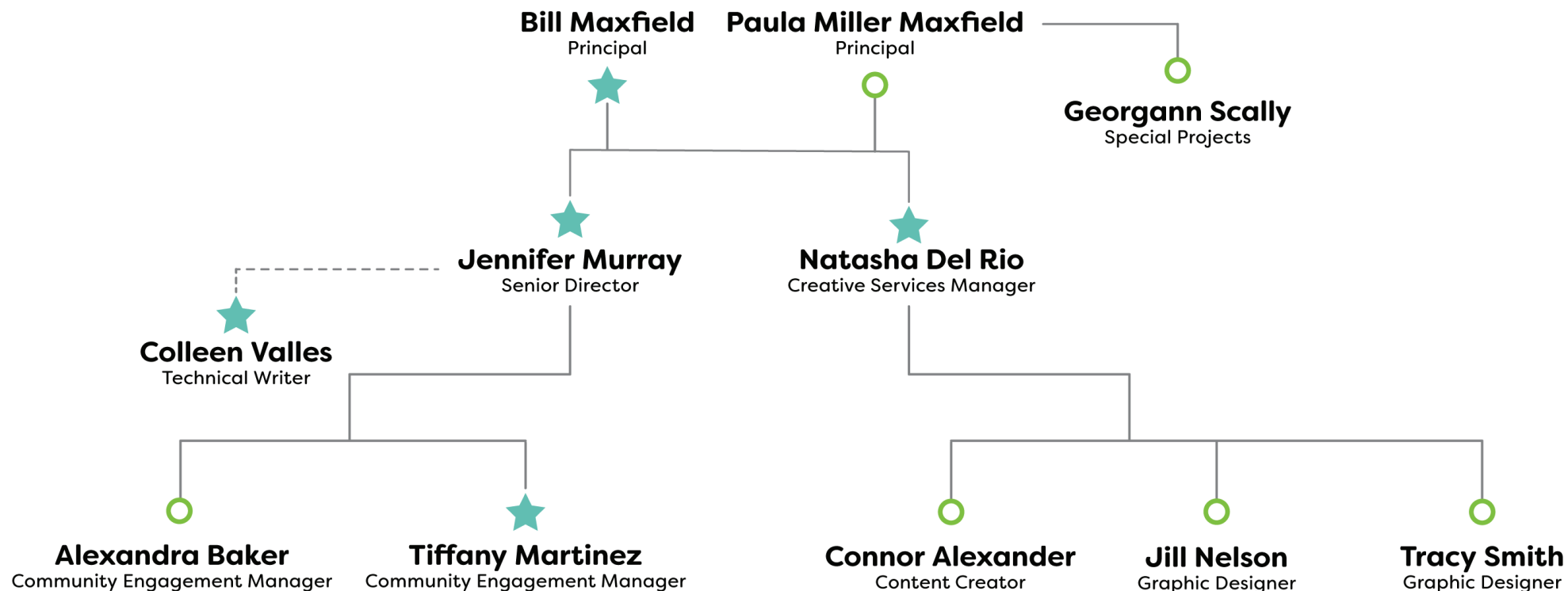

★ SLVWD Primary Team

Resumés



Bill Maxfield, Principal

For 25 years, Bill has been creating and implementing innovative communication plans. He is known for his unique ability to transform communication challenges into

communication wins, a skill he has leveraged through positions held in the public, private and nonprofit sectors. In addition to communication roles held at Silicon Valley start-ups, Bill served as Assembly Budget Committee Chair John Laird's communications director for five years until Mr. Laird's term ended. Today, Bill leads the team at Miller Maxfield, Inc. through strategic planning, message development, community engagement, media relations and crisis management. Bill has developed Miller Maxfield's presence in the public sector, working on behalf of many of the region's most important organizations and projects.

Relevant Work History

- Principal, Miller Maxfield, Inc. (2009-present)
- Communications Director, CA State Assemblymember and Budget Committee Chair John Laird, Sacramento and Santa Cruz, CA (2004-2008)

Education

Bill graduated from San José State University with a degree in Political Science-Public Administration and a minor in Business Management.

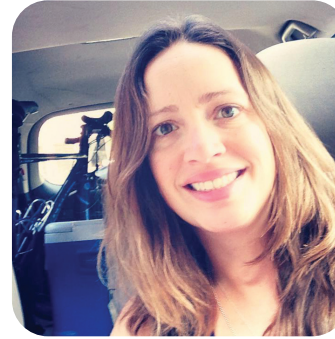

Jennifer Murray, Senior Director

Jennifer Murray is an award-winning writer, editor and multimedia journalist. A communications professional with more than a decade of experience crafting stories and managing content distribution

in both online and traditional formats, Jennifer keeps her finger on the pulse of emerging communication channels. Jennifer also delivers as a stellar event planner, known for her organization and management of the beloved Mole & Mariachi Festival and numerous local triathlon events. Jennifer is the senior director at Miller Maxfield. In this role, she coordinates projects, provides strategic and creative input to clients, secures earned media coverage through compelling press releases, manages social media accounts on multiple platforms, oversees advertising campaigns, develops website content and collaborates with clients to tell their stories.

Relevant Work History

- Senior Director, Miller Maxfield, Inc., Santa Cruz, CA (2014-present)
- Senior Local Editor, Patch.com (AOL Newsmedia), Watsonville, CA (2010-2013)
- Reporter, Santa Cruz Sentinel, Santa Cruz, CA, (2006-2010)

Education

Jennifer graduated from Southern Oregon University with a degree in Communications-Journalism and a minor in Ethics.



Tiffany Martinez, Community Engagement Manager

Skilled in a variety of community outreach and engagement strategies and tactics, Tiffany brings a high level of organization, attention to detail and tenacity to her work. Tiffany served as the branding and communications associate for YWCA of Monterey County. In that role, Tiffany led the planning and execution of several community awareness campaigns including Stand Against Racism, Human Trafficking Awareness and the MC Gives fundraising campaign. Tiffany served as the head editor for SJSU's Communication Studies Program/Cognella Academic Publishing, co-authoring auxiliary materials for the "Empowering Public Speaking" textbook written by Deanna Fassett & Keith Nainby.

Relevant Work History

- Community Engagement Manager, Miller Maxfield, Inc., Santa Cruz, CA (2021-present)
- Executive Assistant/Communication & Branding Associate, YWCA Monterey County, Salinas, CA (2020-2021)
- Head Editor, SJSU Communication Studies Program/Cognella Academic Publishing, San Jose, CA (2020)

Education

Tiffany graduated from Cal State University-Chanel Islands with a degree in Business Communications and from San José State University with a master's degree in Communication Studies.



Natasha Del Rio, Creative Services Manager

Natasha Del Rio is an adept graphic designer with experience working with a broad set of organizations from corporate brands to small businesses. Natasha's artistic sensibilities are best described as modern and whimsical. With a wide-ranging skillset including hand-made, digital and interactive media, Natasha delivers on-brand designs across different elements. Natasha's experience working in the corporate sector where she created prototypes, brand guides, designed ecommerce pages and public-facing collateral have benefitted from her diverse skillset. Natasha serves as the lead designer for a variety of projects that utilize her expertise in illustration, print design and brand design. As Creative Services Manager, Natasha also manages Miller Maxfield's team of design resources.

Relevant Work History

- Creative Services Manager, Miller Maxfield, Inc., Santa Cruz, CA (2022-present)
- Graphic Designer/Production Coordinator, AdVision Outdoor, Tuscon, AZ (2019-2022)
- Freelance Designer, Self-Employed, Santa Cruz, CA (2018-2022)

Education

Natasha graduated from the University of California, Santa Cruz with a degree in Art & Design: Games & Playable Media.



Colleen Valles, Technical Writer

Colleen Valles is an award-winning writer who helps organizations tell their sustainability stories. After nearly a decade spent as a reporter, which included covering environmental issues for the Associated Press, she turned her research and writing skills toward communications in complex industries including housing and land use, water, transportation, energy and education. Colleen has written a variety of content for publications, public and private organizations, executives and elected officials, always with an eye toward making complicated issues engaging and relatable. Her work combines the two things she's passionate about: writing and making the world a better place.

Relevant Work History

- Digital Brand Journalist, Cella, (2022-present)
- Freelance Sustainability Writer, Freelance, Sacramento, CA (2006-present)
- Public Information Representative II, Santa Clara Valley Water District, San José, CA (2015-2019)

Education

Colleen graduated from the University of California, Santa Barbara with a degree in Arts, English Language and Literature.

Experience and Past Performance

Water agencies in the Monterey Bay area are continuously planning and implementing important programs and infrastructure projects to meet the demands created by impacts from climate changes, drought cycles, supply challenges, aging infrastructure and regulatory requirements. Communication and connection with ratepayers is vitally important.

The Miller Maxfield team has developed an intuitive level of expertise about what works and what does not work when it comes to developing and implementing public outreach plans. What follows are summaries that describe our experience on behalf of several local clients, including water agencies and other public-serving organizations that have relevance to the anticipated work in support of SLVWD. Summaries include Pajaro Valley Water Management Agency, Central Coast Community Energy, Friends of Santa Cruz State Parks, Santa Margarita Groundwater Agency and SLVWD.

Pajaro Valley Water Management Agency (PV Water)

2016 - present

PV Water exists for the purpose of ensuring sustainable groundwater resources for the Pajaro Valley, with a footprint that covers portions of Santa Cruz County and Monterey County. The agency utilizes a Basin Management Plan (BMP) to reduce groundwater overdraft and seawater intrusion. The BMP includes projects and strategies that process and deliver recycled water, develop new water supplies and reduce demand through conservation.

Miller Maxfield serves PV Water to support a wide variety of communication and outreach projects, with a special focus on key infrastructure programs such as the College Lake Integrated Resources Management Project and the Watsonville Area Water Recycling Facility.

Activities have included strategic counsel, securing earned media coverage through writing and distributing press releases, printed and digital materials design and production, development of key messaging documents including frequently asked questions, social media content and execution, and production of web, radio and TV advertising.

Our work on the College Lake project spans several years. Beginning in 2022, major activities will shift to focus on the construction phase of the project. A pipeline associated with the project will span much of the City of Watsonville, creating significant impacts for motorists and other residents. Miller Maxfield is anticipated to support PV Water throughout the construction phase by executing community outreach meetings, advertising, direct mail, project signage, social media, earned media and more.

Contact: Brian Lockwood, General Manager, (831) 722-9292
Average Annual Budget: \$35,500

See examples on [page 17](#)

Experience and Past Performance

Central Coast Community Energy (formerly Monterey Bay Community Power)

2016 - present

Miller Maxfield was selected in 2016 to support communications and marketing needs for Monterey Bay Community Power during the pre-JPA/agency formation phase for the effort to establish the entity in Monterey, San Benito and Santa Cruz Counties.

During the pre-JPA/agency formation phase for Monterey Bay Community Power, we provided messaging, branding, social media, media relations, public affairs and community outreach services. Specific services included establishment of core messaging and talking points, design and production of printed materials and giveaway items, PowerPoint presentations, launch and maintenance of social media channels, email newsletter, local media engagement through press releases and story pitching, Spanish translation of all printed materials, development and execution of community engagement events, strategic counsel and creation of an award-winning video.

In 2020, Miller Maxfield was awarded the opportunity to rebrand Monterey Bay Community Power as Central Coast Community Energy. The new name and brand reflect the agency's expansion into San Luis Obispo and Santa Barbara Counties. The rebrand work included brand story development, logo creation (informed by a survey-based customer and stakeholder input process), supporting icons, email newsletter template, brand usage guide, print and digital ad campaigns, website review, brand rollout strategy, and full graphic design and marketing support through and beyond the rebrand launch.

Miller Maxfield continues to provide strategic counsel and graphic design services on an annual basis.

Contact: Peter Berridge, Manager of Energy Communications,
(831) 641-7204

Average Annual Budget: \$85,000

See examples on [page 17](#)

Experience and Past Performance

Friends of Santa Cruz State Parks

2009 - present

Friends of Santa Cruz State Parks (Friends) works in close partnership with California State Parks through a co-management agreement to support 32 state parks, beaches and historic parks, covering all of Santa Cruz County and coastal San Mateo County. Miller Maxfield serves all of Friends' marketing/communications needs. Friends supports State Parks by providing over 100 visitor service aides who are Friends' employees, funding numerous State Parks interpreter positions, operating ParkStores and other visitor services, and funding a wide variety of capital improvement projects.

Miller Maxfield's scope of work for Friends includes all of the organization's messaging, media relations, social media, video and photography, graphic design, website, branded merchandise, event promotion and strategic communications planning. Miller Maxfield also served as the event producer/manager for the Mole & Mariachi Festival that ran from 2013-2019.

The San Lorenzo Valley and surrounding area are a major focus of Friends' work because they support Henry Cowell Redwoods (also including the Fall Creek unit of the park) and Big Basin Redwoods. Miller Maxfield's work for Friends took on a new level of importance and urgency during and after the CZU Lightning Complex Fire. While Big Basin was still on fire, we launched the Friends Fire Fund to raise money for those who lost their homes in the park and to help fund the rebuilding process. The Miller Maxfield team, many of whom are proposed to serve SLVWD, has visited Big Basin numerous times to help document and tell the story of fire recovery and the planning for rebuilding.

Miller Maxfield's work for Friends related to the CZU Fire has included collaboration with State Parks leadership, narrative development, publicity in support of fundraising, media events and media tours, social media content, and production of a [video and 3D scan](#) of the park to mark the one-year anniversary of the fire. Most recently, Miller Maxfield coordinated the reopening of the park by developing the online reservation system, creating signage and graphics, coordinating media, providing photography support and promoting the reopening through social media.

Contact: Bonny Hawley, Executive Director, (831) 325-1504
Average Annual Budget: \$100,000

See examples on [page 18](#)

Experience and Past Performance

Santa Margarita Groundwater Agency 2018 - 2022

Following initial one-time projects to create the logo and website for Santa Margarita Groundwater Agency, Miller Maxfield was selected to be the communications and outreach support for the agency. Our work was generally organized into two tracks: 1) development of the Communications & Engagement Plan as a required component of the agency's state-mandated Groundwater Sustainability Plan (GSP), and 2) execution of community outreach and engagement activities throughout the agency's work to create and submit the GSP.

Miller Maxfield's community outreach and engagement work spanned a broad range of strategies and activities. A core highlight was assisting with the concept and execution of the agency's 2019 three-part series of community meetings, held in Felton in January, February and March. Our specific responsibilities included creation and production of all printed materials, program/speaker development, event publicity and promotion, on-site event support, video production and media relations.

Other notable highlights included writing a summary of each monthly board meeting, including distilling highly complex concepts; creation of numerous explainer graphics to increase understanding of the GSP; supporting execution of groundwater basin public tours, including concept, materials and publicity; ghost-writing and placing op-eds; executing the community event, "Drought: Global Challenge, Local Solutions"; development of the Communications & Engagement Plan, informed by a high degree of collaboration with staff; and layout/design for the GSP final document.

Contact: Piret Harmon, SMGWA staff, (831) 600-1902

Average annual budget: \$35,000

See examples on [page 18](#)

Experience and Past Performance

San Lorenzo Valley Water District 2013 - 2018

Miller Maxfield was hired by the San Lorenzo Valley Water District to support the District's ongoing CIP-driven process to fund and upgrade its water system. To support the district's CIP process, we designed and promoted a series of community meetings to encourage public input. In addition, we increased public understanding of the local watershed and key district projects, such as the replacement of Probation Tank. For the Probation Tank, we supported the District by helping to tell the story of the tank, which was accomplished primarily by pitching local media and arranging tours of the tank site that featured remarks and explanation by District representatives. We repeated this approach for other elements of the water system, including pipelines and water treatment.

A marquee project was the grant-funded Intertie Project, which linked previously independent regions of the District and also connected the District to neighboring Scotts Valley Water District for emergency water needs. The Miller Maxfield team provided messaging and continuous updates about the project, culminating in planning and execution of a press conference to celebrate the completion of the project.

Disaster response communications support was a service Miller Maxfield remained on standby to provide, and did so following damage to the Lyon Treatment Plant access road. Our services included writing and distributing updates to media, arranging media access to the site and assisting with follow up responses to media. Similar support was provided for other incidents, such as the Bear Creek Road water main break.

In addition to disaster response support, crisis communications support was also provided to the District during some notable and highly challenging circumstances. Miller Maxfield delivered counsel and advice that emphasized transparency, responsiveness, best practices and professionalism.

Throughout Miller Maxfield's tenure with SLVWD, we supported the District's communications needs related to watershed protection. This was achieved by promoting important watershed projects, such as the Fall Creek Fish Ladder. In addition, we promoted grant awards, the annual Valley Women's Club River & Road Clean Up, Groundwater Awareness Week and more.

Miller Maxfield also provided comprehensive support for the District's response to the 2014 drought, including messaging, media relations, bill inserts, postcards, banners and more.

Services and skillsets provided by Miller Maxfield included writing, media relations, strategy and messaging, community outreach and event management, graphic design, advertising, social media, printing, direct mail production and crisis communications.

Contact: Rick Rogers, District Manager, (831) 338-2153
Average annual budget: \$44,000

See examples on [page 19](#)

Firm's Local Experience

The fact that Santa Cruz County is the second smallest county in California by area can be hard to believe, especially given the immense diversity of our county in terms of geography, individual community characteristics, politics and policy-level challenges. The service area covered by the San Lorenzo Valley Water District, as compared with other areas of the county, is certainly representative of this dynamic.

Every member of the Miller Maxfield team is a resident of Santa Cruz County. Having a solid understanding of the San Lorenzo Valley and how it fits within the rest of the county is a point of pride for Miller Maxfield. For several members of the team, connections to SLV run deep. Bill Maxfield's grandparents ran Camp Campbell in the 1950s and he grew up in the Santa Cruz Mountains, spending summers at daycamp at Highlands Park and birthdays at Roaring Camp. As a young adult, Bill served as president of the North County Democratic Club. Paula Maxfield's family spent summers in Felton in the 1960s and 1970s. Paula and Bill were married in Ben Lomond. Jennifer Murray worked for several years as a daily reporter for the Santa Cruz Sentinel, often spending her days covering news in the Valley.

Beyond the personal stories of the Miller Maxfield team, the firm has more professional Santa Cruz County experience, as well as knowledge of SLVWD and local issues, than any other communications, public relations or marketing firm. Marking 20 years as a locally owned business, Miller Maxfield has served well over 100 local clients, many of which either are based in the Valley, provide services for Valley residents or are otherwise associated with the Valley.

Key local issues include wildfire prevention and suppression; CZU fire recovery, especially with regard to permitting, codes and construction-related issues; housing affordability and availability; economic recovery; and, of course, water supply. Navigating the policymaking landscape and politics is complex in the unincorporated San Lorenzo Valley, with jurisdictions and areas of influence shared across multiple state agencies, county departments and agencies, LAFCO, special districts, JPAs and political representation (which has also recently been impacted by redistricting). And SLVWD's footprint and operations intersect with nearly all them.

Providing water that reliably comes out of customers' taps, SLVWD often operates unnoticed in the community and yet is everywhere at the same time. From Boulder Creek to Felton and the edges of Scotts Valley, SLVWD's system includes pipes, pumps, tanks, treatment facilities and a massive watershed. It's a totally unique system that combines tried-and-true legacy infrastructure with modern web-connected technology, surface water sources with groundwater wells, suburban-style neighborhoods with remote mountain properties, and well-established service areas with newly-merged services areas.

The impact in the community is vast as well. SLVWD plays an important and equalizing role by striving to provide water at rates that are affordable for all residents. It's a tough balancing act because the cost of service is always increasing, driven significantly by the expense of upgrading aging (and/or fire-damaged) infrastructure. Passing along those costs to customers can create economic hardship for some, especially when combined with the ongoing crisis in the cost of housing. The District is also highly integrated in other facets of life in the Valley, especially including work with fire districts, watershed protection efforts, schools and libraries.

Because of the District's central position with regard to life in the Valley, the relationships the District builds and maintains are critical. From the Chamber of Commerce to the school district, from service clubs to fire stations, from news outlets to other water agencies, and from legislators to law enforcement and beyond, productive relationships are essential to the District's success. But most of all, the District's success depends on building trust with ratepayers.



Creative Alternatives

The following creative alternatives are recommended for consideration by SLVWD. Proposed cost estimates are included in the Proposed Fee section of this proposal.

1. Videos

Create a series of 2-3 videos of varying length for use as social media and website content. The videos could also be used as assets in community presentations. In partnership with a local video production company, Miller Maxfield would produce the videos, including concepts, scripts, branding, shoots and project management. The addition of video to SLVWD's community outreach efforts would help the District to tell its story, explain key concepts, encourage efficient use of water, etc.

2. Advertising

Develop an annual advertising plan that would include an ongoing advertising presence with key local media outlets, including but not limited to the SLV Post, Press Banner, Mountain Bulletin and KBCZ. Advertising would be used to augment other core strategies (such as media outreach, social media, etc.) to deliver important messages related to public workshops, drought, critical projects, etc. Miller Maxfield would develop the advertising plan, as well as create and place the advertising. Miller Maxfield bills only for time used to create and manage the advertising and does not charge mark-ups or any other add-on fees.

3. Fleet Messaging

Create simple and impactful messaging and related graphics to be placed on SLVWD's vehicle fleet. The messaging would be used to amplify other District messaging related to drought, watershed management, etc.

Exceptions to this RFP

I, Bill Maxfield, principal of Miller Maxfield, Inc., certify that the RFP has been read in its entirety and we take no exceptions to this RFP including, but not limited to the Consultant Services Agreement.

Signed:



Bill Maxfield

Work Samples: Pajaro Valley Water Management Agency

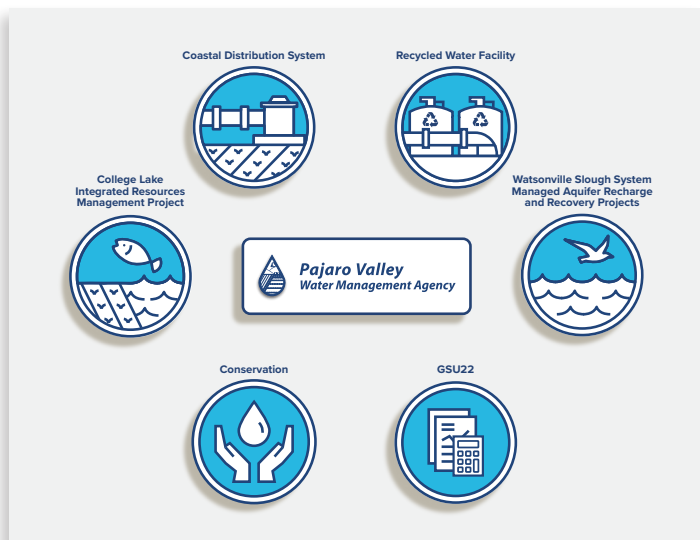

Infographic

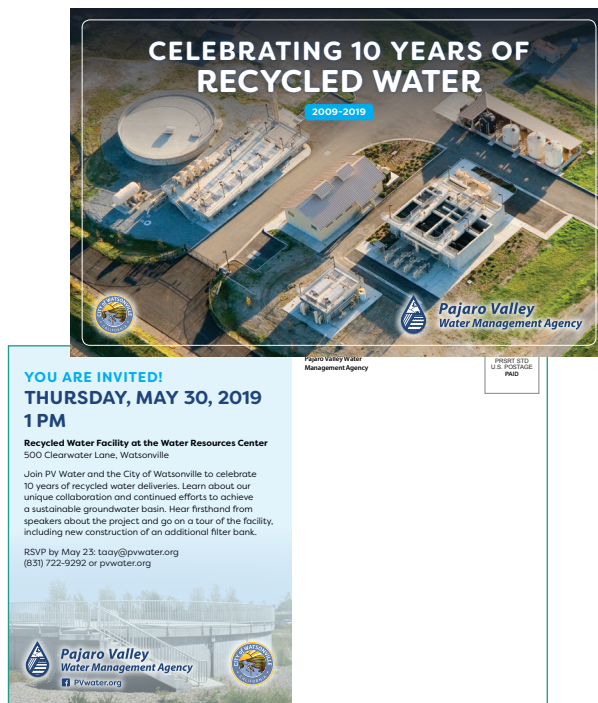

Video: "Pajaro Valley Water Management Agency 2021 TV Ad - English"



[Watch here](#)

Work Samples: Central Coast Community Energy (formerly Monterey Bay Community Power)

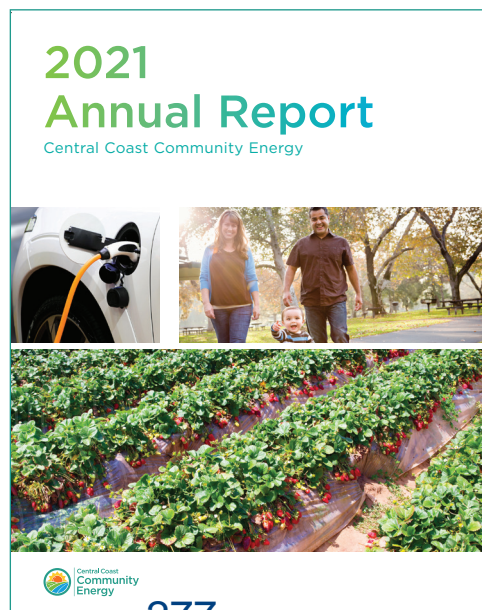

[See Full Document](#)



Digital Ad: English



Digital Ad: Spanish

Video: "3CE Name Change Announcement"

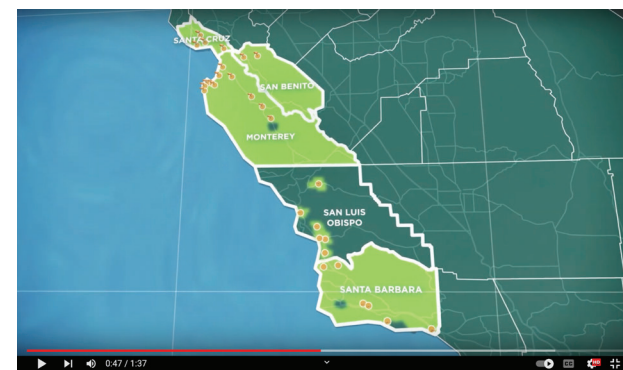

[Watch here](#)

Work Samples: Friends of Santa Cruz State Parks



Big Basin Banner



Fire Fund Postcard

Video: "Big Basin One Year Later"



[Watch here](#)

Work Samples: Santa Margarita Groundwater Agency

SANTA MARGARITA Groundwater Agency

Santa Margarita Groundwater Agency (SMGWA) is a local Groundwater Sustainability Agency created under the 2014 Sustainable Groundwater Management Act (SGMA).

SMGWA was formed in June 2017 by three public agencies: Scotts Valley Water District, San Lorenzo Valley Water District and County of Santa Cruz, and has a responsibility for planning and implementing activities that ensure sustainable use of the groundwater resources in Santa Margarita Basin.

- Groundwater is the primary source of drinking water for majority of the residents in the North Santa Cruz County.
- Groundwater feeds local streams that support fishery habitats.
- Rainfall has been the only source of recharge to the basin.

Groundwater Use in Santa Margarita Basin
(2016, in acre feet)

Scotts Valley Water	1,218
San Lorenzo Valley Water	1,173
Mount Hermon	138
Small Water Companies	80
Commercial/Agricultural	100
Private Residential Wells	220

Event Display Board

COMMUNITY MEETINGS

The Santa Margarita Groundwater Agency (SMGWA) is hosting a three-part "Understanding Our Water" educational series to engage and inform all people who rely on the water supply from the Santa Margarita Groundwater Basin.

JANUARY 12
Land Use and Water: How Much Does Growth Matter?

FEBRUARY 9
Water Budgets: How Do We Balance All Needs?

MARCH 9
Managing Groundwater: How Can We Prepare for an Uncertain Future?

The Santa Margarita Groundwater Basin is the major water source for communities in the San Lorenzo Valley, Scotts Valley, the City of Santa Cruz and unincorporated areas of County of Santa Cruz.

SMGWA is a Groundwater Sustainability Agency formed in June 2017 and includes Scotts Valley Water District, San Lorenzo Valley Water District and the County of Santa Cruz.

Felton Community Hall, 6191 Hwy 9, Felton
All meetings are 9am-1pm
Learn more: smgwa.org

SANTA MARGARITA
Groundwater Agency

Event Promo Flyer

SANTA MARGARITA
Groundwater Agency

Drought: Global Challenge, Local Solutions

JULY 31, 2021 10AM TO NOON
SKYPARK, 361 KINGS VILLAGE ROAD, SCOTTS VALLEY, CA

Learn about the work Santa Margarita Groundwater Agency is doing to create a sustainable water future in the San Lorenzo Valley and Scotts Valley.

Join Us!

Kids Activities!

Scan me to sign up!

Santa Margarita Groundwater Agency tiene un evento comunitario gratuito centrado en los recursos hídricos locales. Únase a nosotros en Skypark en Scotts Valley el 31 de julio desde las 10 AM a 12 PM. Todos están invitados y bienvenidos.

Event Promo Flyer

Work Samples: San Lorenzo Valley Water District



COMMUNITY CHATS

San Lorenzo Valley Water District Acting District Manager Rick Rogers has been hosting a series of informal drop-in coffee chats to talk with District customers, gather feedback on issues and answer questions.

Catch the last one!
October 24
WEDNESDAY 9-10 AM

Heavenly Roadside Café
1210 Mt Hermon Road, Scotts Valley
Open to the public

[SLVWD.COM](https://www.slvwd.com)

Event Promo Flyer

Dear Customer,

San Lorenzo Valley Water District is requesting that customers limit water use this summer due to several factors.

The District is constructing a new water storage tank to service your neighborhood. The new 500,000-gallon steel tank will replace the "Probation Tank," an old, leaking, 100,000-gallon redwood tank, and will increase fire protection for your area. A temporary water storage system that holds 30,000 gallons is in place for the duration of construction.

The District is also affected by recorded rainfall that is 56% of normal this year. In addition, the drought has had a long-term impact on groundwater levels and well efficiency in your area. Currently, two of the three wells serving your area are offline. One is being rehabilitated; the other has reached the end of its life expectancy and is in the process of being replaced.

Please take immediate action to reduce your water use by 20% as the District improves infrastructure in your area.

We appreciate everything you do to ensure your community has a sufficient water supply during summer months and through the end of the construction period. For water conservation tips, please visit watersavingtips.org.

Thank you!

Learn more at www.slvwd.com.



Garden Irrigation
Please limit watering time; or after 5 pm. Shut off nozzle, all hoses and overwatering. For more tips, visit s

San Lorenzo Valley Water District
13060 Highway 9
Boulder Creek, CA 95006

PRIST STD
U.S. POSTAGE
PAID
Boulder Creek, Ca
PERMIT NO. 210



Water supply impacted by infrastructure improvements & drought

CONSERVE TO PRESERVE
SLVWD.COM

San Lorenzo Valley Water District
13060 Highway 9
Boulder Creek, California 95006

Stage 2 Outdoor Water Restrictions Now In Effect

- No outdoor watering between 10am-5pm.
- No outdoor watering on Monday.
- Outdoor irrigation is permitted only three days a week.
- If your address ends in an EVEN number, water only on Tuesday, Thursday and Saturday.
- If your address ends in an ODD number, water on Wednesday, Friday and Sunday.
- On your watering days, limit irrigation to 15 minutes per assigned day.
- Do not wash down hard or paved surfaces.
- Shut-off nozzles are required on all hoses.
- Penalties will apply when restrictions are violated.

To help you manage your water use, monthly billing begins in May.

We're here to help. For additional information and free water conservation devices, as well as conservation tips and rebates, visit [slvwd.com](https://www.slvwd.com) or facebook.com/SLVWaterDistrict, or call 831.338.2153.

Help Out— We're in a Drought

A Drought Emergency has been declared for the San Lorenzo Valley Water District.

Stage 2 Outdoor Water Restrictions in effect, beginning May 1.

Please help our community cut overall water use by 20%.

We're all in this together.

[slvwd.com](https://www.slvwd.com)



Writing Sample: Friends of Santa Cruz State Parks

FOR IMMEDIATE RELEASE

June 30, 2022

Big Basin Redwoods State Park Reopens July 22 with Reservation-Only Day-Use Access

Limited public access to the fire-scarred park returns almost two years after CZU Fire

BOULDER CREEK, Calif. — California State Parks and Friends of Santa Cruz State Parks today announced Big Basin Redwoods State Park will partially reopen July 22 for limited day-use access through a reservation system. Reservations will be available starting July 1.

Big Basin has been closed to the public since the [CZU Lightning Complex Fire](#) tore through the park in August 2020. Flames engulfed more than 97 percent of the park on August 18, 2020, destroying nearly every structure, including the Park Headquarters, campgrounds and housing for park employees. Approximately 18,000 acres burned inside the park boundary. The park is still without electricity, water, flush toilets, phone service or buildings.

“The changes to Big Basin are profound, but the forest is starting to recover and it’s amazing to witness,” said California State Parks Santa Cruz District Superintendent Chris Spohrer. “We want to share the recovery process with visitors, including telling the story of what happened, the status today and the plans for reimagining the park. We’re excited to be able to welcome visitors back on a limited basis as we near the two-year anniversary of the fire.”

“Managing parks for a healthy future for environmental systems as well as humanity could not be more important at this moment in history,” said California State Parks Director Armando Quintero. “We welcome all Californians and visitors from around the world as we enter the next era for this iconic and much beloved state park.”

Limited Reopening

The day-use-only reservation system will provide public access to a small area of the fire-damaged park. Visitors will be able to explore the Redwood Loop and access about 18 miles of fire roads near the historic park core. Services will be limited.

The public access to Big Basin coincides with the reopening of Highway 236, the main thoroughfare through the park. Once open, drivers may go through the park on Highway 236 without stopping. All parking within the park will be by reservation only. Visitors can also access the park by bicycle or METRO bus route 35, which runs on weekends only, without a reservation.

“We are proud to partner with State Parks to bring the public back to Big Basin,” Friends of Santa Cruz State Parks Executive Director Bonny Hawley said. “The devastation of the CZU Fire reminded all of us how beloved and special this park is to generations of visitors. While it will not look like the same Big Basin visitors remember, we hope visitors will enjoy making new memories during this pivotal time for the park.”

[Friends](#), through its unique position as co-management partner with State Parks, will manage the Big Basin Day-Use Reservation System. Reservations will be available online at [Big Basin Redwoods State Park](#) or by phone (831) 338-8867. Most spaces will be available by up to 60 days in advance, while a limited number of reservations will be released three days before the visit date. Initially, 45 spots will be offered daily. Pre-registration is required. No day-of, drive-up entry will be available. Entry is \$6, plus a \$2 reservation fee, and will provide day-long access to the park. State Parks day-use passes, and other park entry programs will be honored, including the recently expanded Golden Bear Park Pass, which provides free access to State Parks for families receiving CalWORKS benefits and others.

Writing Sample: San Lorenzo Valley Water District

FOR IMMEDIATE RELEASE

September 26, 2017

SLV WATER DISTRICT BOARD TAKES ACTION ON CLIMATE CHANGE POLICY AND CONFIRMS SUPPORT FOR PARIS CLIMATE ACCORD

NEW CLIMATE ACTION PLAN AND ENERGY/CLIMATE POLICY TO BE IMPLEMENTED

BOULDER CREEK, CA – The San Lorenzo Valley Water District (SLVWD) today announced the Board of Directors has unanimously (5-0) approved a resolution that confirms the district's commitment to the goals of the Paris Climate Accord and sets new goals and policies on energy efficiency, distributed energy generation and energy procurement, and climate change adaptation.

"San Lorenzo Valley Water District's commitment to the Paris Agreement, and their plans to set specific goals to eliminate carbon from their operations, is a prime example of how local and state governments have begun leading the charge on climate action," said John Laird, California Natural Resources Secretary. "We all need to be working toward a post-carbon future."

The resolution approved by the Board of Directors includes:

1) SLVWD's commitment to the elements of the Paris Agreement that are applicable to the Water District.

2) Direction to SLVWD staff to prepare a Climate Action Plan and District Energy/Climate Policy, elements of which could include:

- Inventory existing energy uses and identify cost savings/energy efficiency priorities.
- Reduce and eventually eliminate greenhouse gas (GHG) emissions resulting from activities related to serving water to the San Lorenzo Valley Water District community.
- Identify and ensure energy and water reliability/resiliency with regard to climate impacts experienced locally.
- Emphasize communication, transparency and education by affirming the importance of education, training, public awareness, public participation and public access to information and cooperation.
- Expand focus on water conservation because it results in conserving electricity, reduces greenhouse gas emissions and promotes sustainable use of water resources.
- Explore development of renewable energy sources, which could include solar, wind, micro hydro, anaerobic digestion or purchasing power through Monterey Bay Community Power.
- Produce an annual report on energy use, conservation and cost.

- Identify strategies for identifying, assessing and adapting to climate change impacts likely to occur in the District's service area.

3) Implementation of the approved plan and policies.

BACKGROUND

In September 2008, SLVWD adopted resolution No. 2 (08-09) Climate Change and Water Resource Management through which the district committed to implementing the goal of the California Global Warming Solutions Act (AB 32) to reduce GHG emissions to 1990 levels by 2020; and to further reduce GHG emissions to 80% below 1990 levels by 2050.

Several additional pieces of legislation related to climate change and energy efficiency have come into force since AB 32. These seek to improve energy efficiency, building energy performance, and increase renewable energy generation in California. The district's actions regarding climate action are both aligned with the state's goals, and may be able to take advantage of programs and funding sources supporting climate action.

The district has continued to exercise leadership in initiatives, programs and policies that address climate change while furthering the district's mission. The district has applied understanding of climate change and its impacts as appropriate in water supply plans, asset management and infrastructure plans, California Environmental Quality Act assessments and habitat conservation plans, energy management plans, business plans and strategic plans. It has also strived to minimize its greenhouse gas emissions, worked with the community to reduce its greenhouse gas emissions related to utilization and management of water resources, and enhanced community understanding of climate change and how climate change impacts the district's mission.

In August 2017 the SLVWD Environmental Committee met and discussed a three-step outline to reduce and eventually eliminate greenhouse gas emissions resulting from district activities. The committee requested that the outline and a resolution be agendized for consideration and possible action.

ABOUT THE SAN LORENZO VALLEY WATER DISTRICT

The San Lorenzo Valley Water District is located in the mountains of northern Santa Cruz County. The district serves more than 7,800 metered connections across approximately 160 miles of pipeline, supported by dozens of water tanks, pumps and wells. Established in 1941 and supplied by a mix of surface water and underground water sources, the district provides water to the communities of Boulder Creek, Brookdale, Ben Lomond, Zayante, Scotts Valley, Mañana Woods, Felton and Lompico. For more information, visit www.slvwd.com or www.facebook.com/slvwaterdistrict.

Writing Sample: Santa Margarita Groundwater Agency

Santa Cruz Sentinel

Guest Commentary | Community participation is key to future of water supply

By BRUCE MCPHERSON, LOIS HENRY and CHRIS PERRI
April 14, 2019 at 5:00 p.m.

In the Sentinel's March 24 story about the San Lorenzo River Symposium, the river was described as a "unifying force of nature." The same could be said of the Santa Margarita Groundwater Basin, which lies beneath much of the river's length, extends throughout the San Lorenzo Valley and Scotts Valley areas and provides water for water district customers and private well owners.

Approximately 40,000 people rely on water that is pumped out of the Santa Margarita Groundwater Basin through wells and delivered to taps every day. Most of us don't spend much time imagining what is happening deep under our feet in the basin. But a new state law, the Sustainable Groundwater Management Act, requires our community to take a closer look and create a plan to make sure the groundwater supply is sustainable for decades to come.

In response, the Santa Margarita Groundwater Agency was formed. The agency includes representatives from San Lorenzo Valley Water District, Scotts Valley Water District, County of Santa Cruz, Mount Hermon Association, City of Scotts Valley, City of Santa Cruz and private well owners.

What the state requires our community to do is challenging. Land development, population growth and climate change make planning for the future very complicated. The new state law requires us to face these challenges and work together as a community to create a plan.

The plan will not be created by unnamed government employees and elected officials. Our community must develop the plan together. Strong public engagement is both wanted and needed. So far, the response has been great.

A three-part "Understanding Our Water" educational series was hosted by the Santa Margarita Groundwater Agency in January, February and March. Each workshop included a keynote speaker, panel discussions with experts, break-

out sessions and informational displays. Approximately 100 people from Scotts Valley, the San Lorenzo Valley and Santa Cruz attended each four-hour event, all of which were held at the Felton Community Hall.

For many, the break-out sessions were the best part because attendees engaged directly with each other, water management staff and elected officials. Small groups huddled for discussion, then reported out their ideas and conclusions. At the end of each workshop, water agency managers answered questions from the audience.

The first workshop, "Land Use and Water: How Much Does Growth Matter?," shared information on land use planning and how it relates to water supply. The keynote speech was by John Laird, former California Secretary of Natural Resources.

The second workshop, "Water Budgets: How Do We Balance All Needs?," covered how water moves through the soil and rocks of the Santa Margarita Groundwater Basin (hydrogeology). Experts provided insight into the complicated relationship between groundwater and surface water, and explored the concept of "water budgets." Assemblymember Mark Stone was our keynote speaker.

At the final workshop, "Managing Groundwater: How Can We Prepare for an Uncertain Future?" audience members had the opportunity to challenge water agency managers in a discussion about myths and misconceptions about how groundwater is managed locally. We also listened to a sobering presentation by Dr. Bruce Daniels about climate change and its implications for our future. We also held a small group exercise about long-range water management scenarios.

For the full op-ed, visit: <https://www.santacruzsentinel.com/2019/04/14/guest-commentary-community-participation-is-key-to-future-of-water-supply/>

Writing Sample: Santa Margarita Groundwater Agency

SANTA MARGARITA
Groundwater Agency

Engagement and Public Outreach

Stakeholder involvement and public outreach is critical to the GSP development and implementation because it helps promote the plan development, based on input and broad support. The following activities summarize involvement opportunities and outreach methods to inform target audiences and stakeholders. It is important to note that levels of interest will evolve and shift according to the GSP's development stage.

Goals and Outcomes

An email listserve of interested persons and organizations is created and maintained. The listserve includes stakeholders that represent the region's broad interests, perspectives and geography. It is developed by leveraging existing lists and by conducting research of potential stakeholders that may be interested in one or all of the following categories: municipal users and groundwater users including private pumpers, community/neighborhood, agricultural, environmental, industrial, institutional, business, disadvantaged communities, state lands and agencies, and integrated water management. Members of the public also can sign up for the listserve via the SMGWA website.

Audience/Stakeholder Contact Strategies

Groundwater Users in the Basin

- **Scotts Valley Water District customers (all)**
How to contact: Email newsletters, bill inserts, newspaper advertising, social media, presentations to board of directors, community events
- **San Lorenzo Valley Water District customers (all)**
How to contact: Email newsletters, bill inserts, newspaper advertising, social media, presentations to board of directors, community events
- **Mount Hermon Association, private well residential users, and small water systems (all)**
How to contact: Newspaper advertising, social media, community events, postcard mailing, agency-led well owner meetings
- **Non-profit organizations and government agencies**
Email newsletters, newspaper advertising, social media, presentations, direct outreach to key staff

9

[See Full Document](#)

283

SANTA MARGARITA
Groundwater Agency

Key Messages and Talking Points

The C&E Plan is intended to be transparent and direct about how the GSP will impact stakeholders.

Key messages and talking points include:

- SMGWA represents the groundwater interests of all beneficial uses and users of the basin equitably and transparently to ensure that the Basin achieves and maintains sustainable groundwater conditions.
- SMGWA is working to sustainably manage local groundwater to meet all users' needs without harming the environment or jeopardizing future water supply reliability.
- SMGWA is committed to working with stakeholders using an open and transparent communication and engagement process.
- As the overall GSP will be more comprehensive with an engaged group of stakeholders providing useful information, SMGWA will create substantial opportunities to educate stakeholders on basin conditions and the GSP process to facilitate soliciting their feedback on GSP development.
- As updating and implementing the GSP will be most successful with an engaged community, outreach will be ongoing past the GSP submittal date.

These messages are being used as the basis for specific talking points/Q&A/FAQ documents to support effective engagement with audiences. The SMGWA Guiding Principles also are used to support communication with audiences (see Appendix).

Strategies for Engagement

The SMGWA utilizes a variety of tactics to achieve broad, enduring and productive involvement with stakeholders during the development of the GSP. Below are activities that SMGWA uses to engage the public:

- Develop and maintain a list of interested parties
- Public informational sessions
 - » "Understanding Our Water" three-part education series
 - » "Undesirable Results – the SGMA Road to What Should be Avoided" workshop
 - » "State of Surface Water in the Santa Margarita Basin" workshop
 - » "The Path to Groundwater Sustainability: Goals and Challenges" discussion
 - » Virtual PWO meeting hosted on Zoom and broadcast live on Facebook
- SMGB tours
- Interviews conducted by Sacramento State, Consensus and Collaboration Program (as a third-party neutral facilitator to SMGWA)

10

Writing Sample: City of Sunnyvale

Our Water:

One of the most precious commodities on earth—clean water—is something we tend to take for granted. But do you know what goes into ensuring that clean water comes out of your tap every time you turn it on? Planning, preparation and the cooperation of the community keep the water flowing. This is particularly important when climate change is making California's water future uncertain.



The San Luis Reservoir stores water that has traveled south from the Sacramento-San Joaquin Delta.

Sourcing and Buying



Calero Reservoir is one of 10 reservoirs operated by Valley Water in Santa Clara County.

Treating and Distributing



Senior Water Distribution Worker Manuel Hernandez checks water pressure and chlorine levels at the City's pump stations.

About half of Sunnyvale's water starts its journey in Lake Oroville and Lake Shasta, hundreds of miles away.

It flows through the Sacramento-San Joaquin Delta to the Santa Clara Valley Water District (Valley Water) for treatment. From there, it gets delivered to Sunnyvale's water system. The rest of our water flows down the Tuolumne River and into Hetch Hetchy Reservoir. The San Francisco Public Utilities Commission (SFPUC) treats that water before it comes to Sunnyvale.

Before we can get any of that water, we pay for it. Like most of the Bay Area, Sunnyvale buys water because there is not enough local

rainfall to meet all the city's needs. When planning how much to buy, we consider existing water demand and any projected development.

But purchasing water isn't cheap. In fact, it costs Sunnyvale 60% of the revenues we get from selling water to our customers. The rest of our revenue goes toward testing, and infrastructure construction, maintenance and repair. Statewide challenges also are driving up the cost of water. These include drought, climate change, wildfires and environmental demands.

Once we have the water, we make sure it's clean—one of the most important jobs we do.

Sunnyvale's drinking water meets or exceeds all federal and state drinking water standards. Valley Water and SFPUC treat most of our water, but we also monitor and test our water quality. We send monthly water quality reports to state and federal agencies.

Then it's time to send water to homes and businesses throughout the city. This uses our extensive network of infrastructure that most people never see. Our network includes four water plants that pump the water into 340 miles of pipe. A state-of-the-art system monitors and controls the flow and pressure of

water. We have set it up so that if the power goes out, the water doesn't.

We also hold millions of gallons of water in reserve in water tanks to meet emergencies like fighting fires. If we need to supplement our water supply during droughts, infrastructure failures or other water shortages, we have wells that tap into groundwater. We currently have very little need to pump from our wells. However, they could supply nearly half of our daily water demand if necessary. We sample the water and check the wells every week to make sure they are ready to go if we need them.



Recycled water represents 3% of the City's total water supply. We have been producing recycled water since 1993. We currently deliver it to 120 customers for non-potable uses such as cooling towers and irrigation.

Water Use: Then, Now & Beyond

Water use in Sunnyvale has decreased even as the population has increased. Though our population increased 40% since 1985, water use has dropped

by more than half. And projections for 2040 show the average number of gallons each person uses per day staying about the same even though our population will grow by 25%. What has contributed to reduced water use? High tech and research and development offices have replaced

Keeping Up the Flow

A Drop in the Bucket

Your Price for Water Compared to Other Liquids (average price per gallon)



Planning and Maintaining



Maintaining the City's infrastructure includes repairing or replacing water mains due to age or condition.

Using and Conserving

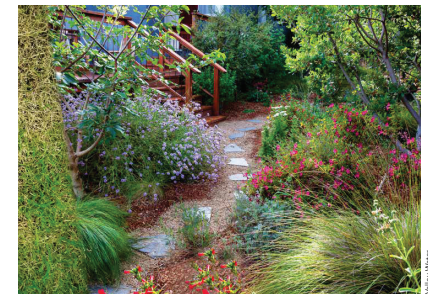

Sustainable landscapes adapt to our rainfall patterns and can thrive with minimal watering.

We must plan for and invest in our water system if it is to remain reliable and meet our water needs.

Sunnyvale's state-mandated Urban Water Management Plan details the plans for our water future every five years.

The City Council adopted the last Urban Water Management Plan in 2016. The Council will consider the updated version this summer. The plan helps the City determine its water needs and how it will meet them. It looks at a variety of factors that will influence the water situation, including:

- The reliability of water sources over the next 20 years, in both normal and dry years.
- The demand for water, based on population and other influences.
- Use of recycled water, conservation, and plans in the case of water shortages.

The plan has helped the City determine how to deal with aging infrastructure. Sunnyvale has set aside \$85 million over the next 20 years to replace water lines. Maintaining and improving old facilities will help ensure a reliable supply of water.

We have already upgraded two water plants and have \$7.5 million to improve pump stations over the next two years. We have \$4 million set aside next year to rehabilitate water tanks.

In a state prone to drought, having this plan helps the City weather water challenges.

Sunnyvale's residents and businesses have made conservation a way of life.

We can see the impact of this lifestyle change over time. In 1985, the City of Sunnyvale used 53% more water than we do today, even though we had far fewer people then.

This year, additional conservation efforts will be necessary until water conditions improve. The SFPUC and Valley Water have both called for Bay Area customers to reduce their water use beyond current restrictions. There is a good reason for these requests. We live in a dry climate, making it harder to know what our water future holds. And when we begin to see consecutive years of below-normal snowpack and rainfall, we must dip into our water reserves. The snowpack, which melts and becomes water for the state, is 60% below the median as of late May. Water levels in Lake Shasta and Lake Oroville are

at 53% and 47% of their historical averages. The entire state is now in varying degrees of drought, according to the U.S. Drought Monitor. By comparison, only 2% of the state was in a drought in October 2019.

Doing your part to conserve now will help preserve our water supply and reduce the impact of droughts. Simple steps like fixing leaks, turning off the water while brushing your teeth, and reducing the days you water your landscape will help meet conservation goals.

Learn more about other water saving tips, tools and rebates at Sunnyvale.ca.gov, search: Water Conservation.

water-intensive industries, like canneries and semiconductor manufacturing. Revised building codes set new standards for sustainability and require water and energy efficiency. And water conservation has become a way of life in our drought-prone state.

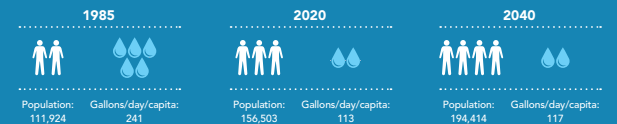

EXHIBIT C

Proposed Total Professional Fee and Fee Schedule

Proposed Total Professional Fee & Fee Schedule

Prepared by Miller Maxfield, Inc.

Strategic Communications & Public Affairs
133 Mission Street, Suite 101
Santa Cruz, CA 95060
(831) 227-6469



Miller Maxfield, Inc.
Strategic Communications
& Public Affairs

Our Rates

- Principal - \$175/hr
- Account Manager - \$150/hr
- Technical Writer - \$150/hr
- Designer - \$125/hr

ONGOING: AGENCY CONSULTING AND SUPPORT	Timing	Subtasks/Deliverables	Hour Per Task - Principal	Cost Per Task - Principal	Hours Per Task - Account Mgmt	Cost Per Task - Account Mgmt	Hours Per Task - Graphic Design	Cost Per Task - Graphic Design	Hours Per Task	Total Cost Per Task
Marketing outreach audit	Aug 2022- Sept 2022	Review current outreach efforts, materials and messaging; provide report of findings and recommendations	2	\$350.00	2	\$300.00	0	\$-	4	\$650.00
Strategic planning, counsel & messaging	Aug 2022- July 2023	Kickoff meeting for goal and messaging alignment; Ongoing strategic counsel; messaging revisions	12	\$2,100.00	12	\$1,800.00	0	\$-	24	\$3,900.00
Community workshops & events	Oct 2022- Feb 2023	Planning, promotion and on-site support for community events/workshops hosted by SLVWD (estimate 3 events during 12-month period)	10	\$1,750.00	60	\$9,000.00	10	\$1,250.00	80	\$12,000.00
Social media	Sept 2022- July 23	Content development and execution; monthly content calendars, photos and graphics	8	\$1,400.00	25	\$3,750.00	10	\$1,250.00	43	\$6,400.00
Outreach materials	Sept 2022- July 2023	Graphic design services in support of events, workshops, eNews, website and collateral (postcards, doorhangers, signage), events and other outreach materials as needed	6	\$1,050.00	15	\$2,250.00	40	\$5,000.00	61	\$8,300.00
e-Newsletters	Oct 2022- July 2023	Content, layout and execution support for newsletters and other eblasts	5	\$875.00	22	\$3,300.00	8	\$1,000.00	35	\$5,175.00
Media relations	Sept 2022- July 2023	Writing/editing of fact sheets, FAQs, etc.; writing and distribution of press releases; media outreach strategy and support; plan, promote and coordinate media events	12	\$2,100.00	40	\$6,000.00	0	\$-	52	\$8,100.00
Project Management	Aug 2022- July 2023	Monthly written progress reports; attend meetings monthly; regular communications as needed	20	\$3,500.00	48	\$7,200.00	0	\$-	68	\$10,700.00
		Hours	75		224		68		367	
		Hourly Rate		\$175.00		\$150.00		\$125.00		
		Cost		\$13,125.00		\$33,600.00		\$8,500.00		\$55,225.00

ON-CALL:	Proposed Timing	Subtasks/Deliverables	Hour Per Task - Principal	Cost Per Task - Principal	Hours Per Task - Account Mgmt	Cost Per Task - Account Mgmt	Hours Per Task - Graphic Design	Cost Per Task - Graphic Design	Total Hours Per Task	Total Cost Per Task
Technical Writing	Oct 2022- Feb 2023	Review of technical source documents; writing and editing; design and layout of documents	8	\$1,400.00	22	\$3,300.00	6	\$750.00	36	\$5,450.00
ADDITIONAL RECOMMENDED ACTIVITIES	Proposed Timing	Subtasks/Deliverables	Hour Per Task - Principal	Cost Per Task - Principal	Hours Per Task - Account Mgmt	Cost Per Task - Account Mgmt	Hours Per Task - Graphic Design	Cost Per Task - Graphic Design	Total Hours Per Task	Total Cost Per Task
Video	Oct 2022- Feb 2023	Concept and script development in collaboration with video production partner; graphic design/art direction including branding; project management for 2-3 videos of varying length (15 seconds to 3 minutes) for use on website and social media	8	\$1,400.00	25	\$3,750.00	4	\$500.00	37	\$5,650.00
Third-party Cost		Video production		\$7,500						\$7,500
Advertising	Oct 2022- Feb 2023	To support maximum participation in community workshops/events, ad placements with SLV local media SLV Post, Press Banner, Mountain Bulletin KBCZ, and Facebook (promoted posts). Create advertising plan and budget; design ads and coordinate submissions	4	\$700.00	10	\$1,500.00	8	\$1,000.00	22	\$3,200.00
Third-party Cost		Ad buys/insertions with media outlets								\$5,000
Fleet messaging	Oct 2022- Feb 2023	Develop messaging and graphics to be installed on fleet vehicles (example: drought/conservation)	4	\$700.00	4	\$600.00	10	\$1,250.00	18	\$2,550.00
Third-party Cost		Branding production and installation								\$2,000.00

EXHIBIT D

Agreement for Professional Services, September 30, 2022

Exhibit D

San Lorenzo Valley Water District

Contract No. 22/23-7

AGREEMENT FOR PROFESSIONAL SERVICES
by and between
SAN LORENZO VALLEY WATER DISTRICT
and
MILLER MAXFIELD, INC.
CONTRACT NO. 22/23-7

Strategic Communications & Public Affairs

PREAMBLE

This agreement for the performance of professional services ("Agreement") is made and entered into as of this 30th day of September 2022 ("Effective Date"), by and between Miller Maxfield, Inc. with its principal place of business located at 133 Mission street suite 101 Santa Cruz, CA ~~95062~~ ⁹⁵⁰⁶⁰, hereinafter referred to as "Consultant," and the San Lorenzo Valley Water District, a California County Water District, with its principal place of business located at 13060 Highway 9, Boulder Creek, CA 95006, hereinafter referred to as "District." District and Consultant may be referred to individually as a "Party" or collectively as the "Parties."

RECITALS

- A. WHEREAS, on June 23, 2022, District issued a Request for Proposals, Request for Qualifications for Communications and Community Outreach Services; and
- B. WHEREAS, Consultant represents and warrants that it possesses the professional qualifications and expertise required by District as set forth under the Request for Proposals and this Agreement.

Now, THEREFORE, the Parties mutually agree as follows:

1. **SCOPE OF SERVICES**

- A. Consultant agrees to perform the services (the "Services") provided for in **Exhibit A**, entitled "RFP for Communications & Outreach Services," attached hereto and incorporated herein. Except as otherwise specified in this Agreement, Consultant shall furnish all technical, legal and professional services, including labor, material, equipment, transportation, supervision and expertise to satisfactorily complete the Services at Consultant's sole risk and expense.
- B. Consultant shall be responsible for the quality, technical accuracy, and coordination of Services furnished by it under this Agreement. Consultant will provide the Services in a manner consistent with the level of care and skill ordinarily exercised by other professionals providing the same or similar services in the region. Consultant shall be solely responsible to District for the performance of Consultant, and any of its employees, agents, subcontractors, subconsultants, or suppliers, that provide any Services or work under this Agreement.

San Lorenzo Valley Water District

Contract No. 22/23-7

2. TERM OF AGREEMENT

Consultant shall provide the Services commencing upon the Effective Date. Consultant shall complete the Services by July 30, 2023. Any extension shall be by amendment.

3. CONSULTANT COMPENSATION

- A. Consultant shall bill District on a monthly basis for any Services provided by Consultant during the preceding month, pursuant to the rates set forth in **Exhibit B**, "Proposed Total Professional Fee & Fee Schedule," attached hereto and incorporated herein. In no event shall the amount of this Agreement exceed **\$55,225.00**. Any increase of this not-to-exceed amount shall be by amendment.
- B. Consultant may begin Services prior to the execution and the Effective Date of this Agreement solely at its own risk, with the understanding that District may elect in its sole and absolute discretion whether or not to compensate Consultant for any Services so provided.

4. GUARANTEED MAXIMUM COSTS

- A. District's obligation hereunder shall not at any time exceed the amount of this Agreement as stated herein. Any increase of the not-to-exceed amount shall be by amendment.
- B. Officers and employees of District are not authorized to request, and District is not required to reimburse Consultant for, commodities or services beyond the agreed upon scope of Services unless the changed scope is authorized by amendment.
- C. Officers and employees of District are not authorized to offer or promise, nor is District required to honor, any offered or promised additional funding in excess of the maximum amount of funding for which the contract is authorized without an amendment authorizing additional funding.

5. PAYMENT; INVOICE FORMAT

- A. Invoices furnished by Consultant under this Agreement must be in a form acceptable to the District Manager or designee.
- B. Payment shall be made by District to Consultant at the address specified in the Section entitled "Notices to the Parties."
- C. District may withhold payment in any instance in which Consultant has failed or refused to satisfy any material obligation provided for under this Agreement.
- D. Payment by District typically will be made within thirty (30) days of the date of receipt of Consultant's invoice by District. However, in no event shall District be liable for interest or late charges for any late payments.

San Lorenzo Valley Water District

Contract No. 22/23-7

6. **PAYMENT DOES NOT IMPLY ACCEPTANCE OF WORK**

The granting of any payment by District, or the receipt thereof by Consultant, shall in no way lessen the liability of Consultant to replace unsatisfactory work, equipment, or materials, although the unsatisfactory character of such work, equipment or materials may not have been apparent or detected at the time such payment was made. Materials, equipment, components, or workmanship that do not conform to the requirements of this Agreement may be rejected by District and in such case must be replaced by Consultant without delay. This Section shall survive termination of this Agreement.

7. **GRANT REQUIREMENTS**

[Intentionally omitted.]

8. **DISALLOWANCE**

[Intentionally omitted.]

9. **QUALIFIED PERSONNEL**

Services and work under this Agreement shall be performed only by competent personnel under the supervision of and in the employment of Consultant, except as may be allowed pursuant to the Section of this Agreement entitled "Subcontracting." Consultant will comply with District's reasonable requests regarding assignment of personnel, but all personnel, including those assigned at District's request, must be supervised by Consultant. Consultant shall commit adequate resources to complete the project within the project schedule specified in this Agreement.

10. **SUBCONTRACTING**

- A. Consultant is prohibited from subcontracting this Agreement or any part of it unless such subcontracting is first approved by District in writing. Neither Party shall, on the basis of this Agreement, contract on behalf of or in the name of the other Party. An agreement made in violation of this provision shall confer no rights on any Party and shall be null and void.
- B. Nothing contained in this Agreement or otherwise, shall create any contractual relation between District and any subcontractors or subconsultant, and no subcontract shall relieve Consultant of its responsibilities and obligations hereunder. Consultant agrees to be as fully responsible to District for the acts and omissions of its subcontractors or subconsultants and of persons either directly or indirectly employed by any of them as it is for the acts and omissions of persons directly employed by the Consultant. Consultant's obligation to pay its subcontractors or subconsultants is an independent obligation from District's obligation to make payments to Consultant.
- C. Any subcontract entered into as a result of this Agreement, shall contain all the applicable grant requirements (see Exhibit C hereto) and provisions stipulated in this Agreement to be applicable to subcontractors or subconsultants.

San Lorenzo Valley Water District

Contract No. 22/23-7

- D. Any substitution of subcontractors or subconsultants must be approved in writing by District advance of assigning work to a substitute subcontractor or subconsultant.

11. PROMPT PROGRESS PAYMENT TO SUBCONSULTANTS

A prime consultant shall pay to any subcontractor or subconsultant not later than seven days of receipt of each progress payment by District, in accordance with the provision in Section 7108.5 of the California Business and Professions Code concerning prompt payment to subconsultants. The 7-day period is applicable unless a longer period is agreed to in writing. Prime consultants are prohibited from holding retainage from subcontractors or subconsultants. Any violation of Section 7108.5 shall subject the violating consultant to the penalties, sanctions, and other remedies of that Section. This requirement shall not be construed to limit or impair any contractual, administrative, or judicial remedies, otherwise available to the prime consultant in the event of a dispute involving a late payment or nonpayment, deficient subconsultant or subcontractor performance, and/or noncompliance by a subconsultant or subcontractor.

12. PROPRIETARY OR CONFIDENTIAL INFORMATION OF DISTRICT

Consultant understands and agrees that, in the performance of the work or Services under this Agreement or in contemplation thereof, Consultant may have access to private or confidential information which may be owned or controlled by District and that such information may contain proprietary or confidential details, the disclosure of which to third parties may be damaging to District. Consultant agrees that all information disclosed by District to Consultant shall be held in confidence and used only in performance of the Agreement. Consultant shall exercise the same standard of care to protect such information as a reasonably prudent contractor would use to protect its own proprietary data. Nothing furnished to Consultant that is otherwise generally known to the public or is of public record shall be deemed confidential under this Section. This Section shall survive termination of this Agreement.

13. OWNERSHIP OF RESULTS

Any interest of Consultant or its subcontractors or subconsultants, in drawings, plans, specifications, blueprints, studies, reports, memoranda, computation sheets, computer files and media or other documents prepared by Consultant or its subcontractors or subconsultants in connection with services to be performed under this Agreement, shall become the property of and will be transmitted to District. However, Consultant may retain and use copies for reference and as documentation of its experience and capabilities. This Section shall survive termination of this Agreement.

14. WORKS FOR HIRE

If, in connection with services performed under this Agreement, Consultant or its subcontractors or subconsultants create artwork, copy, posters, billboards, photographs, videotapes, audiotapes, systems designs, software, reports, diagrams, surveys, blueprints, source codes or any other original works of authorship, such works of authorship shall be works for hire as defined under Title 17 of the United States Code, and

San Lorenzo Valley Water District

Contract No. 22/23-7

all copyrights in such works are the property of District. If it is ever determined that any works created by Consultant or its subcontractors or subconsultants under this Agreement are not works for hire under U.S. law, Consultant hereby assigns all copyrights to such works to District, and agrees to provide any material and execute any documents necessary to effectuate such assignment. With the approval of District, Consultant may retain and use copies of such works for reference and as documentation of its experience and capabilities. This Section shall survive termination of this Agreement.

15. INSURANCE REQUIREMENTS

- A. Without in any way limiting Consultant's liability pursuant to the Section of this Agreement entitled "Hold Harmless/Indemnification," Consultant must maintain in force, during the full term of the Agreement, insurance in the following amounts and coverages:
1. Commercial General Liability Insurance with limits not less than \$1,000,000 each occurrence Combined Single Limit for Bodily Injury and Property Damage, including Contractual Liability, Personal Injury, Products and Completed Operations; and
 2. Workers' Compensation, in statutory amounts, with Employers' Liability Limits not less than \$1,000,000 each accident; and
 3. Commercial Automobile Liability Insurance with limits not less than \$1,000,000 each occurrence Combined Single Limit for Bodily Injury and Property Damage, including Owned, Non-Owned and Hired auto coverage, as applicable; and
 4. Professional Liability Insurance with limits not less than \$2,000,000 per claim. Subconsultants or subcontractors providing professional services under this Agreement, if any, shall be added to Consultant's policy as additional insured, or shall provide evidence of their own professional liability insurance which is acceptable to District.
 5. Commercial General Liability and Business Automobile Liability insurance policies must provide the following:
 - (a) Name as Additional Insured the District, its Officers, Agents, and Employees; and
 - (b) That such policies are primary insurance to any other insurance available to the Additional Insureds, with respect to any claims arising out of this Agreement, and that insurance applies separately to each insured against whom claim is made or suit is brought.
- B. All policies required by this Agreement shall provide thirty days' advance written notice to District of cancellation at the address specified in the Section of this Agreement entitled "Notices to the Parties."

San Lorenzo Valley Water District

Contract No. 22/23-7

- C. Should any of the required insurance be provided under a claims-made form, Consultant shall maintain such coverage continuously throughout the term of this Agreement and, without lapse, for a period of three years beyond the expiration of this Agreement, to the effect that, should occurrences during the term give rise to claims made after expiration of the Agreement, such claims shall be covered by such claims-made policies.
- D. Should any of the required insurance be provided under a form of coverage that includes a general annual aggregate limit or provides that claims investigation or legal defense costs be included in such general annual aggregate limit, such general annual aggregate limit shall be double the occurrence or claims limits specified above.
- E. Should any required insurance lapse during the term of this Agreement, requests for payments originating after such lapse shall not be processed until District receives satisfactory evidence of reinstated coverage as required by this Agreement, effective as of the lapse date. If insurance is not reinstated, District may, at its sole option, terminate this Agreement effective on the date of such lapse of insurance.
- F. Prior to commencement of any work or Services under this Agreement, Consultant, shall, at its sole cost and expense, furnish to District certificates of insurance, and additional insured policy endorsements, in form and with insurers satisfactory to District, evidencing all coverages set forth above, and shall furnish complete copies of policies promptly upon District's request.
- G. Approval of the insurance by District shall not relieve or decrease the liability of Consultant hereunder. This subsection shall survive termination of this Agreement.

16. RESPONSIBILITY FOR EQUIPMENT

District shall not be responsible for any damage to persons or property as a result of the use, misuse or failure of any equipment used by Consultant, or by any of its employees or agents, even though such equipment be furnished, rented or loaned to Consultant by District. This Section shall survive termination of this Agreement.

17. CORRECTION OF SERVICES

District may elect in its sole and absolute discretion, to give Consultant the opportunity to correct any incomplete, inaccurate or defective Services, and Consultant hereby agrees, if given such opportunity pursuant District's election under this Section, to correct such Services at no further cost to District, when such defects are due to the negligence, errors or omissions of Consultant. This Section shall survive termination of this Agreement.

18. HOLD HARMLESS/INDEMNIFICATION

- A. Consultant shall indemnify and hold harmless District and its officers, agents and employees from any and all loss, damage, injury, liability, damages, judgments, claims of any and every kind resulting directly or indirectly from Consultant's

San Lorenzo Valley Water District

Contract No. 22/23-7

performance of this Agreement, including, but not limited to, the use of Consultant's facilities or equipment provided by District or others, regardless of whether liability without fault is imposed or sought to be imposed on District, except to the extent that such indemnity is void or otherwise unenforceable under applicable law, and except where such loss, damage, injury, liability or claim is the result of the active negligence or willful misconduct of District and is not contributed to by any act or omission of Consultant, its subcontractors or subconsultants or their agent or employee. The foregoing indemnity shall include, without limitation, reasonable fees of attorneys, consultants and experts and related costs.

- B. Consultant shall indemnify and hold District harmless from all loss and liability, including attorneys' fees, court costs and all other litigation expenses for any infringement of the patent rights, copyright, trade secret or any other proprietary right or trademark, and all other intellectual property claims of any person or persons in consequence of the use by District, or any of its officers or agents, of articles or services to be supplied in the performance of this Agreement.
- C. This Section 18 shall survive termination of this Agreement.

19. INCIDENTAL AND CONSEQUENTIAL DAMAGES

Consultant shall be responsible for incidental and consequential damages resulting in whole or in part from Consultant's acts or omissions. Nothing in this Agreement shall constitute a waiver or limitation of any rights that District may have under applicable law. This Section shall survive termination of this Agreement.

20. LIABILITY OF DISTRICT

District's payment obligations under this Agreement shall be limited to the payment of the compensation provided for in the Section of this Agreement entitled "Consultant Compensation." Notwithstanding any other provision of this Agreement, in no event shall District be liable, regardless of whether any claim is based on contract or tort, for any special, consequential, indirect or incidental damages, including, but not limited to, lost profits, arising out of or in connection with this Agreement or Services performed in connection with this Agreement. This Section shall survive termination of this Agreement.

21. DEFAULT; REMEDIES

- A. Each of the following shall constitute an event of default ("Event of Default") under this Agreement:
 - 1. Consultant fails or refuses to perform or observe any term, covenant or condition contained in any of the following Sections of this Agreement: 7 ("Grant Requirements"), 9 ("Qualified Personnel"), 10 ("Subcontracting"), 12 ("Proprietary or Confidential Information of District"), 15 ("Insurance Requirements"), 17 ("Correction of Services"), 27 ("Compliance with Laws"), 28 ("Fair Employment"), 29 ("Compliance with Americans with Disabilities Act"), 30 ("Drug Free Workplace"), 31 ("Submitting False Claims; Monetary Penalties"), or 38 ("Assignment").

San Lorenzo Valley Water District

Contract No. 22/23-7

2. Consultant fails or refuses to perform or observe any other term, covenant or condition contained in this Agreement, and such default continues for a period of ten days after written notice thereof from District to Consultant.
 3. Consultant (i) is generally not paying its debts as they become due, (ii) files, or consents by answer or otherwise to the filing against it of, a petition for relief or reorganization or arrangement or any other petition in bankruptcy or for liquidation or to take advantage of any bankruptcy, insolvency or other debtors' relief law of any jurisdiction, (iii) makes an assignment for the benefit of its creditors, (iv) consents to the appointment of a custodian, receiver, trustee or other officer with similar powers of Consultant or of any substantial part of Consultant's property or (v) takes action for the purpose of any of the foregoing.
 4. A court or government authority enters an order (A) appointing a custodian, receiver, trustee or other officer with similar powers with respect to Consultant or with respect to any substantial part of Consultant's property, (B) constituting an order for relief or approving a petition for relief or reorganization or arrangement or any other petition in bankruptcy or for liquidation or to take advantage of any bankruptcy, insolvency or other debtors' relief law of any jurisdiction or (C) ordering the dissolution, winding-up or liquidation of Consultant.
- B. On and after any Event of Default, District shall have the right to exercise its legal and equitable remedies, including, without limitation, the right to terminate this Agreement or to seek specific performance of all or any part of this Agreement. In addition, District shall have the right (but no obligation) to cure (or cause to be cured) on behalf of Consultant any Event of Default; Consultant shall pay to District on demand all costs and expenses incurred by District in effecting such cure, with interest thereon from the date of incurrence at the maximum rate then permitted by law. District shall have the right to offset from any amounts due to Consultant under this Agreement or any other agreement between District and Consultant all damages, losses, costs or expenses incurred by District as a result of such Event of Default and any liquidated damages due from Consultant pursuant to the terms of this Agreement or any other agreement. This subsection shall survive termination of this Agreement.
- C. All remedies provided for in this Agreement may be exercised individually or in combination with any other remedy available hereunder or under applicable laws, rules and regulations. The exercise of any remedy shall not preclude or in any way be deemed to waive any other remedy. This subsection shall survive termination of this Agreement.

22. EARLY TERMINATION FOR CONVENIENCE

- A. District shall have the option, in its sole discretion, to terminate this Agreement, at any time during the term hereof, for convenience and without cause. District shall exercise this option by giving Consultant written notice of termination. The notice shall specify the date on which termination shall become effective.

San Lorenzo Valley Water District

Contract No. 22/23-7

- B. Upon receipt of the notice, Consultant shall commence and perform, with diligence, all actions necessary on the part of Consultant to effect the termination of this Agreement on the date specified by District and to minimize the liability of Consultant and District to third parties as a result of termination. All such actions shall be subject to the prior approval of District. Such actions shall include, without limitation:
1. Halting the performance of all Services and other work under this Agreement on the date(s) and in the manner specified by District.
 2. Not placing any further orders or subcontracts for materials, services, equipment or other items.
 3. Terminating all existing orders and subcontracts.
 4. At District's direction, assigning to District any or all of Consultant's right, title, and interest under the orders and subcontracts terminated. Upon such assignment, District shall have the right, in its sole discretion, to settle or pay any or all claims arising out of the termination of such orders and subcontracts.
 5. Subject to District's approval, settling all outstanding liabilities and all claims arising out of the termination of orders and subcontracts.
 6. Completing performance of any Services or work that District designates to be completed prior to the date of termination specified by District.
 7. Taking such action as may be necessary, or as District may direct, for the protection and preservation of any property related to this Agreement which is in the possession of Consultant and in which District has or may acquire an interest.
- C. Within 30 days after the specified termination date, Consultant shall submit to District a final invoice for Services performed under the Agreement.
- D. In no event shall District be liable for costs incurred by Consultant or any of its subcontractors or subconsultants after the termination date specified by District.
- E. In arriving at the amount due to Consultant under this Section 22, District may deduct: (1) all payments previously made by District for work or other Services covered by Consultant's final invoice; (2) any claim which District may have against Consultant in connection with this Agreement; (3) any invoiced costs or expenses excluded pursuant to the immediately preceding subsection; and (4) in instances in which, in the opinion of District, the cost of any Service or other work performed under this Agreement is excessively high due to costs incurred to remedy or replace defective or rejected Services or other work, the difference between the invoiced amount and District's estimate of the reasonable cost of performing the invoiced Services or other work in compliance with the requirements of this Agreement.

San Lorenzo Valley Water District

Contract No. 22/23-7

F. District's payment obligation under this Section 22 shall survive termination of this Agreement.

23. RIGHTS AND DUTIES UPON TERMINATION OR EXPIRATION

Upon any termination of this Agreement prior to expiration of the term specified in Section 2 (entitled "Term of Agreement") this Agreement shall terminate and be of no further force or effect except as otherwise expressly provided herein. Consultant shall transfer title to District, and deliver in the manner, at the times, and to the extent, if any, directed by District, any work in progress, completed work, supplies, equipment, and other materials produced as a part of, or acquired in connection with the performance of this Agreement, and any completed or partially completed work which, if this Agreement had been completed, would have been required to be furnished to District. This Section shall survive termination of this Agreement.

24. LIQUIDATED DAMAGES

[Intentionally omitted.]

25. AUDIT AND INSPECTION OF RECORDS OF CONSULTANT

Consultant agrees to maintain and make available to District, during regular business hours, accurate books and accounting records relating to its work under this Agreement. Consultant will permit District to audit, examine and make excerpts and transcripts from such books and records, and to make audits of all invoices, materials, payrolls, records or personnel and other data related to all other matters covered by this Agreement, whether funded in whole or in part under this Agreement. Consultant shall maintain such data and records in an accessible location and condition for a period of not less than three years after final payment under this Agreement or until after final audit has been resolved, whichever is later. The State of California or any federal agency having an interest in the subject matter of this Agreement shall have the same rights conferred upon District by this Section. This Section shall survive termination of this Agreement.

26. CONFLICT OF INTEREST

Consultant acknowledges that it is familiar with the provisions of §87100 et seq. of the Government Code of the State of California, and certifies that it does not know of any facts which constitute a violation of said provisions.

27. COMPLIANCE WITH LAWS

Consultant shall keep itself fully informed of all local laws and regulations applicable to District, and of all state, and federal laws in any manner affecting the performance of this Agreement, Consultant must at all times comply with such local laws and regulations and all applicable state and federal laws as they may be amended from time to time.

28. FAIR EMPLOYMENT

During the performance of the Agreement, Consultant shall not discriminate against any person or group of persons on account of race, religious creed, color, national origin, ancestry, physical disability, mental disability, medical condition, genetic information, marital status, sex, gender, gender identity, gender expression, age, sexual orientation, or any other category or characteristic protected by law. Consultant confirms that it has an equal employment opportunity policy ensuring equal employment opportunity without regard to race, religious creed, color, national origin, ancestry, physical disability, mental disability, medical condition, genetic information, marital status, sex, gender, gender identity, gender expression, age, or sexual orientation; and that it maintains no employee facilities segregated on the basis of race, religious creed, color, national origin, ancestry, physical disability, mental disability, medical condition, genetic information, marital status, sex, gender, gender identity, gender expression, age, sexual orientation, and any other category or characteristic protected by law. Consultant further agrees that any violation of this prohibition on the part of Consultant, its employees, agents or assigns will constitute a material breach of this Agreement.

29. COMPLIANCE WITH AMERICANS WITH DISABILITIES ACT

Consultant acknowledges that, pursuant to the Americans with Disabilities Act (ADA), programs, services and other activities provided by a public entity to the public, whether directly or through a contractor, must be accessible to the disabled public. Consultant shall provide the services specified in this Agreement in a manner that complies with the ADA and any and all other applicable federal, state and local disability rights legislation. Consultant agrees not to discriminate against, or fail to make reasonable accommodation of any person covered by the ADA, or fail to comply with any provision of the ADA in the course of its performance of its obligations under the Agreement, or in any way connected with District. Consultant shall defend, indemnify, protect, and hold harmless the District its directors, officers, employees, agents, or authorized volunteers, and each of them, from any and all damages, losses, claims, suits, costs, liabilities, or actions of every kind or description (including attorneys' fees) incurred or brought for, or on account of, Consultant's violation or alleged violation of the ADA in the course of performance of its obligations under the Agreement, or in any way connected to District. Consultant further agrees that any violation of this prohibition on the part of Consultant, its employees, agents or assigns will constitute a material breach of this Agreement.

30. DRUG FREE WORKPLACE

Consultant acknowledges that the unlawful manufacture, distribution, dispensation, possession, or use of a controlled substance is prohibited on District premises. Consultant agrees that any violation of this prohibition by Consultant, its employees, agents or assigns will be deemed a material breach of this Agreement.

31. SUBMITTING FALSE CLAIMS; MONETARY PENALTIES

Pursuant to California Government Code Sections 12650 et seq., any contractor, subcontractor or consultant who submits a false claim shall be liable to District for three times the amount of damages that District sustains because of the false claim. A

contractor, subcontractor or consultant who submits a false claim shall also be liable to District for the costs of a civil action brought to recover any of those penalties or damages, and may be liable to District for a civil penalty for up to \$10,000 for each false claim. A contractor, subcontractor or consultant will be deemed to have submitted a false claim to District if the contractor, subcontractor or consultant: (a) knowingly presents or causes to be presented to an officer or employee of District, a false claim for payment or approval; (b) knowingly makes, uses or causes to be made or used a false record or statement to get a false claim paid or approved by District; (c) conspires to defraud District by getting a false claim allowed or paid by District; (d) has possession, custody, or control of public property or money used or to be used by District and knowingly delivers or causes to be delivered less property than the amount for which the person receives a certificate or receipt; (e) is authorized to make or deliver a document certifying receipt of property used or to be used by District and knowingly makes or delivers a receipt that falsely represent the property used or to be used; (f) knowingly makes, uses, or causes to be made or used a false record or statement to conceal, avoid, or decrease an obligation to pay or transmit money or property to District; (g) is a beneficiary of an inadvertent submission of a false claim to District, subsequently discovers the falsity of the claim, and fails to disclose the false claim to District within a reasonable time after discovery of the false claim. This Section shall survive termination of this Agreement.

32. FORCE MAJEURE

The time for performance of Services to be rendered pursuant to this Agreement may be extended because of any delays due to unforeseeable causes beyond the control and without the fault or negligence of Consultant, including, but not restricted to, acts of God or of any public enemy, acts of the government, fires, earthquakes, floods, epidemic, quarantine restrictions, riots, strikes, freight embargoes and unusually severe weather if Consultant, within ten (10) days of the commencement of such condition, notifies the District Manager who shall thereupon ascertain the facts and extent of any necessary delay, and may extend the time for performing Services. The District Manager's determination shall be final and conclusive upon the Parties to this Agreement.

33. ENTIRE AGREEMENT

This contract sets forth the entire Agreement between the Parties in connection with the subject matter hereof, and supersedes any and all other oral or written communications or provisions. This contract may be modified or amended only as provided in the Section directly below, entitled "Amendments." This Section shall survive termination of this Agreement.

34. AMENDMENTS

It is mutually understood and agreed that this Agreement may not be amended or modified, nor may compliance with any of its terms be waived, except by written instrument executed and approved in the same manner as this Agreement. This Section shall survive termination of this Agreement.

San Lorenzo Valley Water District

Contract No. 22/23-7

35. NON-WAIVER

The omission by either Party at any time to enforce any default or right reserved to it, or to require performance of any of the terms, covenants, or provisions hereof by the other Party at the time designated, shall not be a waiver of any such default or right to which the Party is entitled, nor shall it in any way affect the right of the Party to enforce such provisions thereafter. This Section shall survive termination of this Agreement.

36. NO AGENCY

Consultant shall not have authority, expressed or implied, to act on behalf of District as an agent, or to bind District to any obligations whatsoever, unless specifically authorized in writing by the District Manager. This Section shall survive termination of this Agreement.

37. CONSULTANT IS AN INDEPENDENT CONTRACTOR

A. Consultant or any agent or employee of Consultant shall be deemed at all times to be an independent contractor and is wholly responsible for the manner in which it performs the services and work requested by District under this Agreement. Consultant or any agent or employee of Consultant is liable for the acts and omissions of itself, its employees and its agents. Nothing in this Agreement shall be construed as creating an employment or agency relationship between District and Consultant or any agent or employee of Consultant.

B. Any terms in this Agreement referring to direction from District shall be construed as providing for direction as to policy and the result of Consultant's work only, and not as to the means by which such a result is obtained. District does not retain the right to control the means or the method by which Consultant performs Services or work under this Agreement.

C. This Section 37 shall survive termination of this Agreement.

38. ASSIGNMENT

The Services to be performed by Consultant are personal in character and neither this Agreement nor any duties or obligations hereunder may be assigned or delegated by the Consultant unless first approved by District by written instrument executed and approved in the same manner as this Agreement. This Section shall survive termination of this Agreement.

39. CONSTRUCTION

All section headings are for reference only and shall not be considered in construing this Agreement. No provision of this Agreement shall be construed against any Party hereto by reason of such Party's being deemed to have drafted such provisions. This Section shall survive termination of this Agreement.

San Lorenzo Valley Water District

Contract No. 22/23-7

40. SEVERABILITY

Should the application of any provision of this Agreement to any particular facts or circumstances be found by a court of competent jurisdiction to be invalid or unenforceable, then (a) the validity of other provisions of this Agreement shall not be affected or impaired thereby, and (b) such provision shall be enforced to the maximum extent possible so as to effect the intent of the parties and shall be reformed without further action by the Parties to the extent necessary to make such provision valid and enforceable. This Section shall survive termination of this Agreement.

41. NOTICE TO THE PARTIES

Unless otherwise indicated elsewhere in this Agreement, all written communications sent by the Parties shall be sent via email with a copy by U.S. mail or by express overnight courier with tracking, addressed as follows:

To District:

Rick Rogers
District Manager
San Lorenzo Valley Water District
13060 Highway 9
Boulder Creek, CA 95006
Email: rrogers@slvwd.com

To Consultant:

Bill Maxfield, Principal
133 Mission Street, Suite 101
Santa Cruz, CA 95060
Phone: 831-227-6469
Email: bill@millermxfield.com

Any notice of default must be sent by email with a copy by registered mail or by express overnight courier with tracking.

42. ADMINISTRATIVE REMEDY FOR AGREEMENT INTERPRETATION

Should any question arise as to the meaning and intent of this Agreement, the question shall, prior to any other action or resort to any other legal remedy, be referred to District's General Manager, who shall decide the true meaning and intent of the Agreement. This Section shall survive termination of this Agreement.

43. DISPUTE RESOLUTION

A. District may elect in its sole and absolute discretion to submit any controversies between Consultant and District regarding the construction or application of this

San Lorenzo Valley Water District

Contract No. 22/23-7

Agreement, and claims arising out of this Agreement or its breach, to non-binding mediation, within thirty (30) days after notice of a mediation request is given by one Party to the other Party.

- B. The Parties may agree on one mediator. If the Parties cannot agree on one mediator, the Party requesting mediation may request that the Superior Court, State of California, County of Santa Cruz appoint a mediator. The mediation meeting shall not exceed one day or eight (8) hours. The Parties may agree to extend the time allowed for mediation under this Agreement.
- C. The costs of such mediation shall be borne by the Parties equally.
- D. Mediation under this Section 43, if elected by District, is a condition precedent to filing an action in any court.
- E. This Section 43 shall survive termination of this Agreement.

44. ATTORNEY FEES

In the event any legal action or proceeding is commenced to interpret or enforce the terms of, or obligations arising out of this Agreement, or to recover damages for the breach thereof, the Party prevailing in any such action or proceeding shall be entitled to recover from the non-prevailing Party all reasonable attorneys' fees, costs and expenses incurred by the prevailing Party. This Section shall survive termination of this Agreement.

45. VENUE

The formation, interpretation and performance of this Agreement shall be governed by the laws of the State of California. Venue for all litigation relative to the formation, interpretation and performance of this Agreement shall be exclusively in the state courts of the State of California, County of Santa Cruz, or if jurisdiction is exclusively federal, in the United States District Court, Northern District of California, San Jose. This Section shall survive termination of this Agreement.

46. EXECUTION IN COUNTERPARTS

This Agreement may be executed in counterparts each of which shall be deemed an original but all of which shall constitute one and the same instrument.

47. AUTHORITY

The individuals executing this Agreement represent and warrant that they have the right, power, legal capacity and authority to enter into and to execute this Agreement on behalf of the respective legal entities of Consultant and District.

[Signatures on Following Page(s)]

San Lorenzo Valley Water District

Contract No. 22/23-7

IN WITNESS WHEREOF, the Parties hereto have executed this Agreement on the day first mentioned above, as evidenced by the signatures of their duly authorized representatives set forth below.

SAN LORENZO VALLEY WATER DISTRICT		MILLER MAXFIELD, INC.	
<u>Richard M. Rogers - 10/10/2022</u>		<u>B. Maxfield</u>	
<u>Cathy Blum</u>		<u>Bill Maxfield</u>	
Richard M. Rogers District Manager San Lorenzo Valley Water District		Authorized Signature	
		<u>Bill Maxfield</u>	
		Printed Name	
		<u>Principal</u>	
		Title	
ATTEST:		<u>Miller Maxfield, Inc.</u>	
<u>Holly Hossack</u>		Company Name	
Holly Hossack District Secretary San Lorenzo Valley Water District		<u>133 Mission St, #101</u>	
		Street Address	
		<u>Santa Cruz, CA 95060</u>	
		City, State, ZIP	
APPROVED AS TO FORM:		<u>531-227-6469</u>	
<u>Gina Nicholls</u>		Phone Number	
Gina Nicholls District Counsel Nossaman LLP		<u></u>	
		License Number(s) (if applicable)	

MEMO

DATE: April 4, 2024
TO: Board of Directors, San Lorenzo Valley Water District
FROM: Brian Frus, Interim General Manager
SUBJECT: Possible Modification to the Board Meeting Schedule

WRITTEN BY: Holly Hossack - Admin Assistant / District Secretary
PRESENTED BY: Holly Hossack - Admin Assistant / District Secretary

STAFF RECOMMENDATION

It is recommended that the Board of Directors review the 2025 Holidays and Meetings calendar and by motion of the Board schedule a Special meeting for July 18, 2024 (*the third Thursday*).

RECOMMENDED MOTION

The Board agrees to add a Special Board of Directors meeting on
July ____ 2024 (or)

The Board agrees to keep the schedule as adopted without a July meeting.

BACKGROUND

Section 9 of the Board of Directors Policy Manual approved March 7, 2024 states that the scheduled meetings of the Board of Directors shall be held on the first (1st) Thursday of each month. This year the first Thursday lands on the July 4th holiday.

While it is common to take the month of July off from meetings to allow both the Board and staff time away from the District this can be a crucial time for decisions and a Special Meeting of the Board may be required.

Staff recommends that the Board of Directors set a meeting for July 18, 2024 (the third Thursday) that may simply be canceled if it is not needed.

FISCAL IMPACT

None

ENVIRONMENTAL IMPACT

Pursuant to Title 14, the California Code of Regulations, Section 15302(c) of the California Environmental Quality Act (“CEQA”) guidelines, the proposed action is an administrative activity of the District that will not result in direct or indirect physical changes to the environment.

ATTACHMENTS

- 2024 Holidays & Meeting Calendar

2024

SAN LORENZO VALLEY WATER DISTRICT

SCHEDULE OF HOLIDAYS & MEETINGS

January 2024

S	Mo	Tu	We	Th	Fr	Sa
	1	2	3	4	5	6
7	8	9	10	11	12	13
14	15	16	17	18	19	20
21	22	23	24	25	26	27
28	29	30	31			

February 2024

S	Mo	Tu	We	Th	Fr	Sa
				1	2	3
4	5	6	7	8	9	10
11	12	13	14	15	16	17
18	19	20	21	22	23	24
25	26	27	28	29		

March 2024

S	Mo	Tu	We	Th	Fr	Sa
						1
2	3	4	5	6	7	8
9	10	11	12	13	14	15
16	17	18	19	20	21	22
23	24	25	26	27	28	29
30	31					

April 2024

S	Mo	Tu	We	Th	Fr	Sa
		1	2	3	4	5
6	7	8	9	10	11	12
13	14	15	16	17	18	19
20	21	22	23	24	25	26
27	28	29	30			

May 2024

S	Mo	Tu	We	Th	Fr	Sa
			1	2	3	4
5	6	7	8	9	10	11
12	13	14	15	16	17	18
19	20	21	22	23	24	25
26	27	28	29	30	31	

June 2024

S	Mo	Tu	We	Th	Fr	Sa
						1
2	3	4	5	6	7	8
9	10	11	12	13	14	15
16	17	18	19	20	21	22
23	24	25	26	27	28	29
30						

July 2024

S	Mo	Tu	We	Th	Fr	Sa
	1	2	3	4	5	6
7	8	9	10	11	12	13
14	15	16	17	18	19	20
21	22	23	24	25	26	27
28	29	30	31			

August 2024

S	Mo	Tu	We	Th	Fr	Sa
				1	2	3
4	5	6	7	8	9	10
11	12	13	14	15	16	17
18	19	20	21	22	23	24
25	26	27	28	29	30	31

September 2024

S	Mo	Tu	We	Th	Fr	Sa
1	2	3	4	5	6	7
8	9	10	11	12	13	14
15	16	17	18	19	20	21
22	23	24	25	26	27	28
29	30					

October 2024

S	Mo	Tu	We	Th	Fr	Sa
		1	2	3	4	5
6	7	8	9	10	11	12
13	14	15	16	17	18	19
20	21	22	23	24	25	26
27	28	29	30	31		

November 2024

S	Mo	Tu	We	Th	Fr	Sa
					1	2
3	4	5	6	7	8	9
10	11	12	13	14	15	16
17	18	19	20	21	22	23
24	25	26	27	28	29	30

December 2024

S	Mo	Tu	We	Th	Fr	Sa
1	2	3	4	5	6	7
8	9	10	11	12	13	14
15	16	17	18	19	20	21
22	23	24	25	26	27	28
29	30	31				

BoD MEETINGS 1ST THURSDAY OF EVERY MONTH 5:30PM

ADMINISTRATION 3rd Wed. 3:00 pm, Ackemann*, Fultz, Dolson

BUDGET & FINANCE 2nd Wed. 2:00 pm, Mahood*, Hill, Bahn, Herrick

ENGINEERING & ENVIRONMENTAL 3rd Tues. 2:00 pm, Smolley*, Hill, Lande, Schmelter

HOLIDAYS

*Committee Chair

MEMO

DATE: April 4, 2024
TO: Board of Directors
FROM: Brian Frus, Interim General Manager
SUBJECT: California Conservation Corps Hazardous Tree Mitigation
Contract

WRITTEN BY: Chris Klier, Environmental Planner I
PRESENTED BY: Carly Blanchard, Environmental Program Manager

STAFF RECOMMENDATION

It is recommended that the Board of Directors directs the Interim General Manager to enter into an agreement with the California Conservation Corps for Hazardous Tree Mitigation.

RECOMMENDED MOTION

The Board directs Interim General Manager to enter into an agreement with the California Conservation Corps for Hazardous Tree Mitigation for the Peavine Pipeline Replacement Project.

BACKGROUND

The CZU Lightning Complex Wildfire in 2020 severely damaged District facilities, including the 1.3-mile Peavine Pipeline (Pipeline), which carries raw water and runs between Foreman Creek and Peavine Creek (see map in Attachment B). The Pipeline must be reconstructed to restore critical

surface water supply and will be replaced using above-grade HDPE pipe, as directed by the Board on November 2, 2023.

The District must complete environmental permitting processes prior to any work on the pipeline, and a contract with Panorama Environmental for this work was awarded at the March 7, 2024 Board meeting.

The first phase of the project will be mitigation of more than 500 hazardous trees along the existing 1.3-mile Pipeline bench. Mitigation of these hazard trees is necessary before any other work can be completed, including survey work required to complete pipeline design. Once the hazard tree mitigation, survey, and designs are complete, the next phases will be pipeline bench repair and pipeline reconstruction.

The District is pursuing a contract with the California Conservation Corps (CCC) to perform the hazard tree mitigation work (Attachment A). The CCC has grant funding to provide a crew for the hazardous tree work, providing an estimated \$260,000 of labor. The District is only responsible for funding CCC crew lodging, food, tools, and overtime, which is estimated at \$53,928. The District also plans to contract a consulting forester to supervise the project, costing an estimated \$7,900. The District expects to be reimbursed by FEMA for 90% of these remaining costs.

PRIOR COMMITTEE ACTION

On March 19, 2024, the Environmental and Engineering Committee received a presentation from Environmental staff on the Peavine Pipeline Replacement Project and the proposed CCC Hazardous Tree Removal

contract. The Committee recommended the Board enter into a contract with the California Conservation Corps for Hazardous Tree Mitigation.

FISCAL IMPACT

The total estimated cost to the District for the scope of work is \$61,828. While the District will initially need to pay these costs from reserves, staff expects to be reimbursed for 90% of the costs by FEMA. However, the CCC is covering an estimated additional \$260,000 through grant funding. A total of \$750,000 has been allocated in the FY 23-24 Peavine Pipeline Replacement project CIP budget, thus there are sufficient funds available.

ENVIRONMENTAL IMPACT

The District has executed an agreement with an environmental consultant to determine the nature and extent of any impacts as a result of the various elements comprising this project.

ATTACHMENTS AND RELEVANT LINKS TO DISTRICT WEBSITE

Attachment A - CCC Peavine Hazardous Tree Mitigation Agreement

Attachment B - Peavine Pipeline Map



Project Data

Project Title: Forestry Corps - Peavine R.O.W. Tree Removal

Project Number: R-23-1606-12758

Center Information: 1606 - Salinas Satellite

Contract Information: -

Project Description:

CCC Forestry Corps will remove trees creating hazard to Peavine Pipeline alignment. Trees to be removed vary from from 72 inches DBH and less. CCC will provide advanced level 1 sawyer to fell trees outside of cm's scope, create felling plans, and assess required alternative approaches. This removal will encompass both green, snag, and downed/uprooted trees. Trees marked for removal are included in an inventory documented by a forester. It is expected that there are more trees that may require removal in the ROW due to elapsed time since inventory. Additional removal of non marked trees in ROW will first be consented by the SLVWD. If tree removal is completed prior to allotted spike cycles, remaining allotted labor and spike schedules will be utilized to train cm's for creating tree inventory. CCC will create training project as to provide for Forestry Corps educational requirements.

Sponsor Information

Agency Name: SAN LORENZO VALLEY WATER DISTRICT **Agency Code:** 65014

Mailing Address	Mailing City	Mailing State	Mailing ZIP Code
13060 Hwy 9	Boulder Creek	CA	95006
13060 Hwy 9	Boulder Creek	CA	95006
13060 Hwy 9	Boulder Creek	CA	95006

Sponsor Contact Information:

Contact type	Title	First name	Last name	Phone number	Email address
Sponsor Representative	Environmental Programs Manager	Carly	Blanchard	831-338-2153	cblanchard@slvwd.com
Manager	General Manager	Brian	Frus	831-430-4623	bfrus@slvwd.com
Technical Advisor	Operations Manager	James	Furtado	831-338-2153	jfurtado@slvwd.com

Estimate Information

Estimated Number of Hours: 0

Estimated Start and End Dates: 3/1/24-6/30/25

Work Site Information:

Address	City	State	ZIP code	Geolocation latitude	Geolocation longitude
Easter Seals Camp Harmon 16403 Highway 9	Boulder Creek	CA	95006		



direction to site location	special instructions
From Salinas, map to be provided.	

Fiscal Summary

Total OE&E	Total CM labor amount	Total fiscal summary amount
\$37,800.00	\$0.00	\$53,928.00

Equipment, Materials and Labor

Sponsor Supplied Materials, Equipment and Labor:

Materials: None identified

Equipment: Potential use of UTV's in alternate access route, spike camp facilities, restrooms, potable water, GPS locating if required

Labor: Technical Oversight

BY SIGNING THIS DOCUMENT:

The CCC Representative agrees to the following:

- A Sponsor Agreement (CCC 96 or, where applicable, an Inter Agency Agreement or other Master Agreement) is on file at Headquarters (HQ).
- If the Sponsor is a non-profit entity, a Private Property/Sponsor Authorization form has been submitted to HQ.
- If the Sponsor is a for-profit entity, a Private Property/Sponsor Authorization form has been submitted to HQ.
- The project conforms to the CCC's Injury and Illness Prevention Program (IIPP).
- The signing CCC Representative has the authority to enter into a contractual agreement of this amount with the Sponsor.

The Sponsor Representative agrees to the following:

- Hazardous Materials
 - If there are hazardous materials present, the Sponsor has provided the location, identity, and amounts of any hazardous substances at the worksite and provided all Material Safety Data Sheets (MSDS) for hazards that are present at the worksite.
 - OR
 - To the best knowledge of the Sponsor, the worksite is free of any known hazardous materials.
- All applicable local, state, tribal, and federal permits, approvals, and clearances have been obtained.
- Project Funding
 - For projects funded by the Sponsor or entity other than the CCC, the Sponsor agrees to reimburse the CCC for estimated costs in accordance with the fiscal details shown in this document.



State of California

California Natural Resources Agency

Agenda: 4.4.23

CALIFORNIA CONSERVATION CORPS PROJECT EVALUATION

FORM CCC 58

R-23-1606-12758

Forestry Corps - Peavine R.O.W. Tree Removal

Item 1a

○ OR

- For projects funded internally by CCC's Environmental Programs or other special fund, the Sponsor agrees to comply with all applicable program and eligibility criteria to fund the project.
- The signing Sponsor Representative has the authority to enter into a contractual agreement of this type (and, if any, this amount) with the CCC.



Sponsor Representative:

Print Name: _____

Title: _____

Signature: _____

Date: _____

CCC Representative:

Print Name: _____

Title: _____

Signature: _____

Date: _____

CCC Representative:

Print Name: _____

Title: _____

Signature: _____

Date: _____

CCC Agreement # <div style="border: 1px solid black; height: 20px; width: 100%;"></div> <small>(CCC Contract Officer Assigns)</small>	Index# <div style="border: 1px solid black; padding: 5px; width: 100%; text-align: center;">1606</div> <small>(Center Index Code is Four digits)</small>	CCC Project Number <div style="border: 1px solid black; padding: 5px; width: 100%; text-align: center;">R-23-1606-12758</div> <small>(C3 Assigns)</small>
---	--	---

A] The California Conservation Corps (CCC), agrees to provide crew labor for the project titled:

Forestry Corps - Peavine R.O.W Tree Removal

See CCC-58: Project Evaluation Form for details.

B] The term of this agreement shall be:

Agreement Start Date: March 1, 2024 Check here if multi-year
 Agreement Expiration Date: June 30, 2025

C] Sponsor agrees to reimburse the CCC for estimated costs in accordance with the Fiscal Summary. (Fiscal Year displays are shown on page 2 and page 3.) NOTE TO SPONSOR: Budget detail will not be provided on performance based contracts.	<table border="1" style="width: 100%; border-collapse: collapse; text-align: center;"> <thead> <tr> <th style="width: 30%;">Labor</th> <th style="width: 10%;">Hours</th> <th style="width: 10%;">Rate/Hr</th> <th style="width: 50%;">Totals</th> </tr> </thead> <tbody> <tr> <td>CM Regular Time:</td> <td>0.00</td> <td>\$ -</td> <td>\$ -</td> </tr> <tr> <td>CM Overtime:</td> <td>0.00</td> <td>\$ -</td> <td>\$ -</td> </tr> <tr> <td colspan="3">Performance Based Labor:</td> <td>\$ -</td> </tr> <tr> <td colspan="3">Unspecified:</td> <td>\$ -</td> </tr> <tr> <td colspan="3">Staff Regular Time :</td> <td>\$ -</td> </tr> <tr> <td colspan="3">Staff Overtime :</td> <td>\$ 16,128.00</td> </tr> <tr> <td colspan="4">EXPENSES</td> </tr> <tr> <td colspan="3">Equipment (greater than \$5,000):</td> <td>\$ -</td> </tr> <tr> <td colspan="3">Tools (includes equipment less than \$5,000):</td> <td>\$ 25,000.00</td> </tr> <tr> <td colspan="3">Materials:</td> <td>\$ -</td> </tr> <tr> <td colspan="3">Vehicle Operations:</td> <td>\$ -</td> </tr> <tr> <td colspan="3">Consulting:</td> <td>\$ -</td> </tr> <tr> <td colspan="3">Other:</td> <td>\$ 12,800.00</td> </tr> </tbody> </table>	Labor	Hours	Rate/Hr	Totals	CM Regular Time:	0.00	\$ -	\$ -	CM Overtime:	0.00	\$ -	\$ -	Performance Based Labor:			\$ -	Unspecified:			\$ -	Staff Regular Time :			\$ -	Staff Overtime :			\$ 16,128.00	EXPENSES				Equipment (greater than \$5,000):			\$ -	Tools (includes equipment less than \$5,000):			\$ 25,000.00	Materials:			\$ -	Vehicle Operations:			\$ -	Consulting:			\$ -	Other:			\$ 12,800.00
Labor	Hours	Rate/Hr	Totals																																																						
CM Regular Time:	0.00	\$ -	\$ -																																																						
CM Overtime:	0.00	\$ -	\$ -																																																						
Performance Based Labor:			\$ -																																																						
Unspecified:			\$ -																																																						
Staff Regular Time :			\$ -																																																						
Staff Overtime :			\$ 16,128.00																																																						
EXPENSES																																																									
Equipment (greater than \$5,000):			\$ -																																																						
Tools (includes equipment less than \$5,000):			\$ 25,000.00																																																						
Materials:			\$ -																																																						
Vehicle Operations:			\$ -																																																						
Consulting:			\$ -																																																						
Other:			\$ 12,800.00																																																						

D] The total amount payable by Sponsor to CCC under this agreement shall not exceed: \$ 53,928.00

E] The CCC shall forward billing for labor and/or operating expenses with supporting documentation to the sponsor:
 Monthly Quarterly At end of contract

F] Sponsor agrees to pay CCC within 35 days from receipt of invoice.











Sponsor	
Organization:	
Date:	
Signature:	
Print:	
Title:	
SPONSOR EMAIL ADDRESS	
SPONSOR MAILING ADDRESS	
SPONSOR BILLING ADDRESS:	
<small>___ Check Here if Billing and Mailing Address are the same</small>	

STATE OF CALIFORNIA	
California Conservation Corps	
Date:	
Signature:	
Print:	Tabatha Chavez
Title:	Deputy Director, Administration
CCC CENTER VERIFICATION	
Date:	
Signature:	
Print:	
Title:	Conservation Supervisor
FORWARD PAYMENTS TO:	
California Conservation Corps Attention: Accounting/Receivables 1719 24th Street Sacramento, CA 95816	

Legend

Water Mains

Diameter

-  .75"-1"
-  1.25"-1.5"
-  2"
-  3"
-  4"
-  6"
-  8"
-  10"
-  12"
-  14"
-  Lyon Treatment

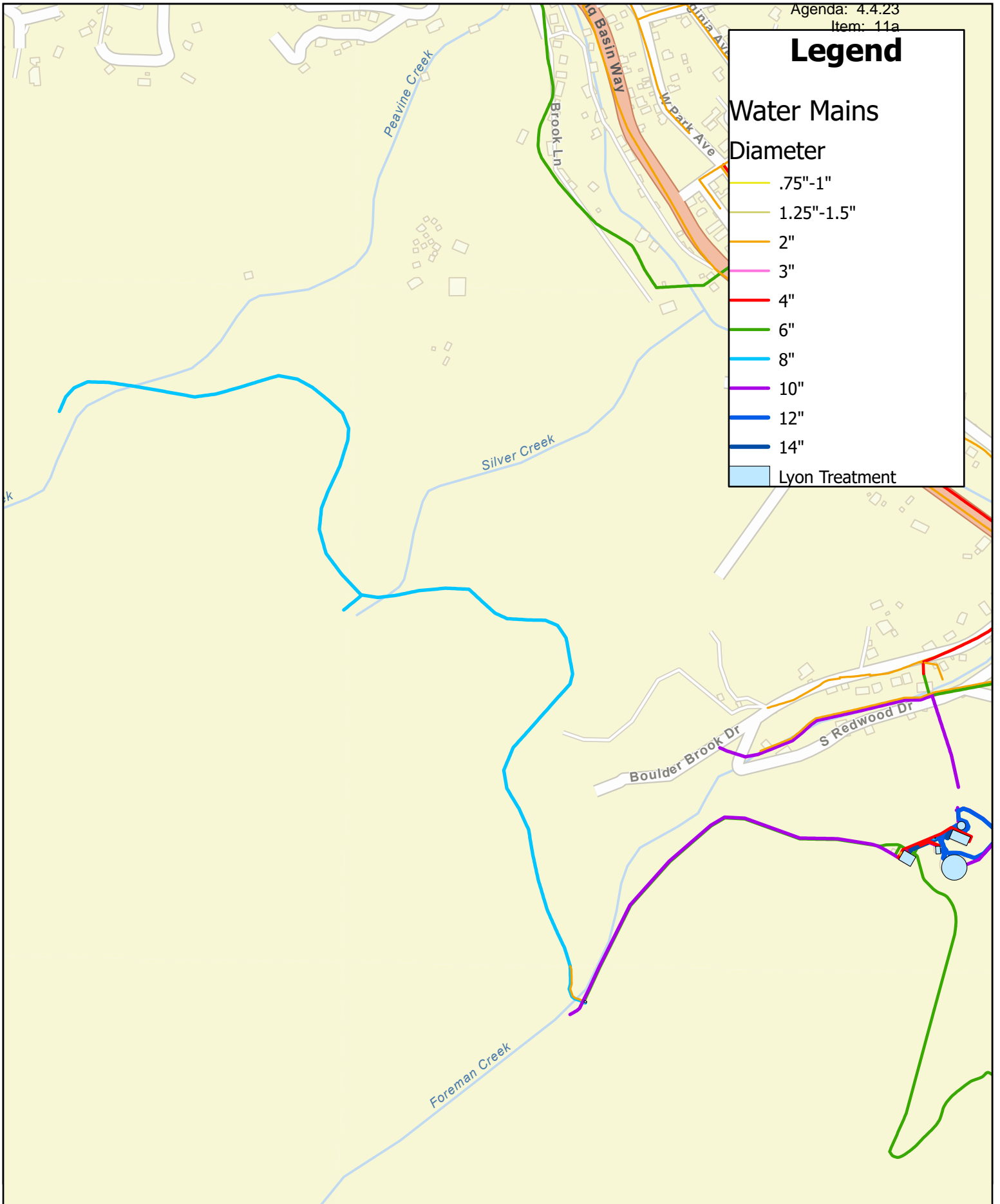

Date: 3/07/2024
Scale: 1:7,000
Drawn By: WWL
Approved By: JWS

Former Peavine Pipeline

13060 Hwy 9
Boulder Creek, CA
95006

1
of
1

MEMO

DATE: April 4, 2024
TO: Board of Directors
FROM: Brian Frus, Interim General Manager
SUBJECT: Agreement with Navigating Preparedness Associates for Local Hazard Mitigation Plan preparation

WRITTEN BY: Chris Klier, Environmental Planner I
PRESENTED BY: Carly Blanchard, Environmental Program Manager

STAFF RECOMMENDATION

The Board of Directors directs the Interim General Manager to enter into an agreement with Navigating Preparedness Associates for Local Hazard Mitigation Plan preparation.

RECOMMENDED MOTION

The Board:

1. Directs the Interim General Manager to enter into an agreement with Navigating Preparedness Associates for preparation of a Local Hazard Mitigation Plan an amount not to exceed \$43,500; and
2. Authorizes the Interim General Manager to execute extensions and/or non-substantive modifications to the Agreement, as necessary.

BACKGROUND

The Hazard Mitigation Grant Program (HMGP) provides funding for communities to implement mitigation activities to reduce risk to life and property from natural hazards. In California, natural hazards are defined as wildfire, earthquake, drought, extreme weather, flooding, and impacts of climate change. In April 2022 the District submitted two sub-applications for the CAL OES Hazard Mitigation Grant Program (HMGP), fire hardening of 3,600 linear feet of HDPE pipeline, and the development of a Local Hazard Mitigation Plan. To be eligible to apply for the HMGP an agency must have an adopted Local Hazard Mitigation Plan (LHMP).

The District has received funding from the California Office of Emergency Services (Cal OES) HMGP for the development of a Local Hazard Mitigation Plan (LHMP). The LHMP will help identify mitigation actions that will make District more disaster resistant and allow access to future Cal OES HMGP funding opportunities.

On January 25, 2024, the District released an RFP seeking a qualified consultant to coordinate, facilitate, and prepare the District LHMP, implementing regulations and guidance as they apply to Special Districts. The District received four proposals and had four key staff complete evaluations. Staff selected Navigating Preparedness Associates to prepare the LHMP in the amount of \$43,500.

PRIOR COMMITTEE ACTION

None.

FISCAL IMPACT

The total estimated cost for the scope of work is \$43,500, which will be 90% covered by the approximately \$140,000 HMGP grant from CalOES. The District is responsible for a 10% match of grant funds, resulting in a total direct cost to the District of \$4,400. No budget amendment is proposed. Based on current year-to-date expenses, there is sufficient department budget to cover the proposed expenses.

ENVIRONMENTAL IMPACT

Pursuant to Title 14, the California Code of Regulations, Section 15302(c) of the California Environmental Quality Act (“CEQA”) guidelines, the proposed action is an administrative activity of the District that will not result in direct or indirect physical changes to the environment.

ATTACHMENTS AND RELEVANT LINKS TO DISTRICT WEBSITE

Attachment A - Professional Services Agreement, Navigating
Preparedness Associates, Local Hazard Mitigation Plan

**PROFESSIONAL SERVICES AGREEMENT
BY AND BETWEEN
THE SAN LORENZO VALLEY WATER DISTRICT
AND
NAVIGATING PREPAREDNESS ASSOCIATES**

THIS PROFESSIONAL SERVICES AGREEMENT (“Agreement”) is made and entered into this 4th day of April 2024, (the “Effective Date”) by and between the San Lorenzo Valley Water District, a California county water district (“District”), and Navigating Preparedness Associates, a California Limited Liability Corporation (“Professional”). District and Professional may herein be referred to individually as a “Party” and collectively as the “Parties.” There are no other parties to this Agreement.

RECITALS

A. District seeks to hire an independent contractor to perform professional services to assist District with the Local Hazard Mitigation Plan (the “Project”).

B. Professional has submitted a proposal to District to provide such professional services. A description of the services Professional proposes to provide (“Services”) is attached hereto as **Exhibit A: Services**. District desires to retain Professional to perform the Services, subject to the terms and conditions set forth in this Agreement.

C. The Parties have outlined the schedule or timeline for providing the Services (“Completion Schedule”), which is attached hereto as **Exhibit A: Services**.

D. The parties have outlined the rates and method of payment to Professional for its performance of the Services under this Agreement (“Compensation Schedule”), which is attached hereto as **Exhibit A: Services**.

NOW, THEREFORE, in consideration of the mutual promises and covenants set forth below, the Parties agree as follows:

AGREEMENT

Section 1. Recitals. The recitals set forth above (“Recitals”) are true and correct and are hereby incorporated into and made part of this Agreement by this reference. In the event of any inconsistency between the Recitals and Sections 1 through 33 of this Agreement, Section 1 through 33 shall prevail.

Section 2. Term. The term of this Agreement shall be one year and will commence on the Effective Date and terminate on the 4th day of April, 2025 (“Term”) unless the Term is extended or the Agreement is terminated earlier pursuant to this Agreement.

{CW021899.2}

Section 3. Effective Date. This Agreement shall only become effective once all the Parties have executed the Agreement (the “Effective Date”).

Section 4. Work.

4.1. Services. Subject to the terms and conditions set forth in this Agreement, Professional shall provide District the Services described in **Exhibit A**. Any request for Services not included in **Exhibit A** will be considered a request for additional or modified Services (“Modification” or “Modifications”). Professional shall not receive additional compensation for any Modification of the Services unless the Parties agree otherwise in a writing executed by both Parties.

4.2. District Requested Modification of Services. District may, by written order, authorize Modifications to the Services described in **Exhibit A**. If such Modifications cause an increase in the cost or time required for performance of Professional’s Services, the Parties shall enter into a written amendment to this Agreement to adjust the Services and the rates to be paid to Professional and, if necessary, amend the Completion Schedule described in **Exhibit A** or Compensation Schedule described in **Exhibit A**. The Services, Completion Schedule, or Compensation Schedule shall not be revised unless District and Professional mutually agree to a written amendment to this Agreement reflecting such revisions, additional compensation, time for performance, or such other terms or conditions mutually agreed upon by the Parties.

4.3. Professional Requested Modification in Services. Professional shall not be compensated for work outside the Services described in this Agreement, unless, prior to the commencement of the work outside the Services:

(a) Professional provides District with written notice that specific work requested by District or required to complete the Project is outside the agreed upon Services. Such notice shall: (i) be supported by substantial evidence that the work is outside the Services; (ii) set forth the Professional’s proposed course of action for completing the work and a specific request for District to approve the Modification to the Services; (iii) set forth the Professional’s proposed revisions, if any, to the Completion Schedule; and (iv) set forth the Professional’s proposed revisions, if any, to the Compensation Schedule; and

(b) District agrees that the work requires a Modification;

(c) District approves all adjustments, if any, to the Completion Schedule and Compensation Schedule; and

(d) The Parties execute a written amendment to this Agreement describing any Modification, together with any adjustment in the Completion Schedule and Compensation Schedule for Professional’s work. Compensation for any additional Services shall not exceed the Compensation Schedule in **Exhibit A**.

Section 5. Compensation.

{CW021899.2}

5.1. Amount, Time, and Manner of Payment for Professional Services. District shall pay Professional according to the rates and timing set forth in the Compensation Schedule in **Exhibit A**. The total amount of compensation to be paid under this Agreement shall not exceed **forty-three thousand five hundred dollars (\$43,500)**. On each anniversary date of the Effective Date, Professional will be allowed to increase prices with thirty (30) days' written notice to District. Increases may not exceed increases in the San Francisco-Oakland Consumer Price Index for all urban consumers or percentage increases in Professional's published prices, whichever is lower. In all cases, District may cancel this Agreement if a requested price increase is not acceptable.

5.2. Payments. District shall make payments in the amount invoiced by Professional within thirty (30) calendar days of receiving such invoice. In the event that an amount of an invoice is in dispute, District shall inform Professional of the amount and basis for the dispute and may withhold the amount which is in dispute until the dispute has been resolved.

5.3. Invoices. Professional shall provide District with monthly invoices sufficiently evidencing Professional's expenses and completion of the Services. All invoices furnished to District by Professional shall be in a form approved by District. The payments specified shall be the only payments made to Professional for performance of the Services, including compensation for any Modification. Professional shall submit all billings for Services to District within forty-five (45) days of the performance of such Services. District shall issue payment according to District's customary procedures and practices for issuing payments to independent contractors.

Section 6. Notice to Proceed. Professional shall not commence the performance of the Services until it has been given notice by District ("Notice to Proceed").

Section 7. Time of Performance. Professional warrants that it will commence performance of the Services within sixty (60) calendar days of the date the Notice to Proceed and shall conform to the Completion Schedule. The time of performance is a material term of this Agreement relied on by District in entering into this Agreement.

Section 8. District Assistance to Professional. Professional shall, at its sole cost and expense, furnish all facilities, equipment, materials, information, personnel, and administrative assistance which may be required to perform its obligations under this Agreement, unless otherwise specified in **Exhibit A** or this Agreement.

Section 9. Duties of District. In order to permit Professional to render the services required hereunder, District shall, at its expense and in a timely manner: (a) Provide such information as Professional may reasonably require to undertake or perform the Services; (b) Promptly review any and all documents and materials submitted to District by Professional in order to avoid unreasonable delays in Professional's performance of the Services; and (c) Promptly notify Professional of any fault or defect in the performance of Professional's services hereunder.

Section 10. Time and Personnel Devoted to Services. Professional shall devote such time and personnel to the performance of this Agreement, as is necessary to perform the Services in compliance with the Completion Schedule, Compensation Schedule, and this Agreement.

{CW021899.2}

Section 11. Performance by Qualified Personnel; No Subcontracting. Services under this Agreement shall be performed only by competent personnel under the supervision and direct employment of Professional. Professional will conform with District's reasonable requests regarding assignment of personnel, but all personnel, including those assigned at District's request, shall be supervised by Professional. Professional is prohibited from subcontracting this Agreement or any part of it unless such subcontracting is expressly approved by District in writing. Neither Party shall, on the basis of this Agreement, contract on behalf of, or in the name of the other Party. An agreement made in violation of this provision shall confer no rights on any Party and shall be null and void.

Section 12. Representations of Professional. District relies upon the following representations by Professional in entering into this Agreement:

12.1. Qualifications. Professional represents that it is qualified to perform the Services provided in **Exhibit A** and that it possesses the necessary licenses and permits required to perform the Services or will obtain such licenses or permits prior to the time such licenses or permits are required. Professional shall also ensure that all subcontractors are similarly licensed and qualified. Professional represents and warrants to District that Professional shall, at Professional's sole cost and expense, keep in effect or obtain at all times during the Term of this Agreement, any licenses, permits, and approvals which are legally required for Professional to practice Professional's profession at the time the Services are rendered.

12.2. Professional Performance. Professional represents that all Services under this Agreement shall be performed in a professional manner and shall conform to the customs and standards of practice observed on similar, successfully completed projects by specialists in the Services to be provided. Professional shall adhere to accepted professional standards as set forth by relevant professional associations and shall perform all Services required under this Agreement in a manner consistent with generally accepted professional customs, procedures, and standards for such Services. All work or products completed by Professional shall be completed using the best practices available for the profession. Professional agrees that, if a Service is not so performed, in addition to all of its obligations under this Agreement and at law, Professional shall re-perform or replace unsatisfactory Service at no additional expense to District.

12.3. No Waiver of Claims. The granting of any progress payment by District, or the receipt thereof by Professional, or any inspection, review, approval or oral statement by any representative of District, or state certification shall not, in any way, waive, limit, or replace any certification or approval procedures normally required or lessen the liability of Professional to re-perform or replace unsatisfactory Service, including, but not limited to, cases where the unsatisfactory character of such Service may not have been apparent or detected at the time of such payment, inspection, review or approval.

12.4. District's Remedies are Cumulative. Nothing in this Section shall constitute a waiver or limitation of any right or remedy, whether in equity or at law, which District or Professional may have under this Agreement or any applicable law. All rights and remedies of District, whether under this Agreement or applicable law, shall be cumulative.

{CW021899.2}

12.5. No Conflict of Interest. Professional represents that no conflict of interest will be created under state or federal law by entering into or in carrying out this Agreement.

Section 13. Conformity with Law and Safety. Professional shall observe and comply with all applicable laws, ordinances, codes, regulations, and permits of governmental agencies, including federal, state, municipal and local governing bodies having jurisdiction over any or all of the scope of Services, including all provisions of the Occupational Safety and Health Act of 1979 as amended, all California Occupational Safety and Health Regulations, the California Building Code, the Americans with Disabilities Act, any copyright, patent, or trademark law, and all other applicable federal, state, municipal and local safety regulations, appropriate trade association safety standards, and appropriate equipment manufacturer instructions. All Services performed by Professional must be in accordance with these laws, ordinances, codes, and regulations, including the administrative policies and guidelines of District pertaining to the work. Professional's failure to comply with any laws, ordinances, codes, or regulations applicable to the performance of the Services hereunder shall constitute a breach of contract. In cases where standards conflict, the standard providing the highest degree of protection shall prevail.

If a death, serious personal injury, or substantial property damage occurs in connection with the performance of this Agreement, Professional shall immediately notify District Manager by telephone. If any accident occurs in connection with this Agreement, Professional shall promptly submit a written report to District, in such form as District may require. This report shall include the following information: (a) Name and address of the injured or deceased person(s); (b) Name and address of Professional's subcontractor, if any; (c) Name and address of Professional's liability insurance carrier; and (d) A detailed description of the accident, including whether any of District's equipment, tools or materials were involved.

If a release of a hazardous material, substance, or waste occurs in connection with the performance of this Agreement, Professional shall immediately notify District Manager.

Section 14. Contact by Professional with Project Owner or Project Applicant. Unless otherwise set forth in the Services, neither Professional nor Professional's subcontractors shall directly contact the owner of the property involved in the Project or any party who is the applicant for the Project ("Interested Party"), or an employee or contractor of an Interested Party, on any matter relating to the Project without the prior consent of District. In no event shall Professional take any instructions or directions from an Interested Party on any matter pertaining to the Professional's Services to be performed for District under this Agreement.

Section 15. Confidentiality. Professional understands and agrees that, in the performance of Services under this Agreement or in the contemplation thereof, Professional may have access to private or confidential information that may be owned or controlled by District and that such information may contain proprietary or confidential details, the disclosure of which to third parties may be damaging to District ("Confidential Information").

Professional shall not, either during or after the Term, disclose to any third party any Confidential Information without the prior written consent of District. If District gives Professional

{CW021899.2}

written authorization to make any such disclosure, Professional shall do so only within the limits and to the extent of that authorization. Professional may be directed or advised by the District's General Counsel on various matters relating to the performance of the Services on the Project or on other matters pertaining to the Project and, in such event, Professional agrees that it will treat all communications between itself, its employees and its subcontractors as being communications which are within the attorney-client privilege.

Notwithstanding the foregoing, Professional may disclose Confidential Information required to be disclosed under law, provided that, prior to disclosure, Professional shall first give notice to District and make a reasonable effort to obtain a protective order requiring that District's Confidential Information not be disclosed. This exception is limited to the extent disclosure is required under law.

Section 16. Ownership of Work Product. Any and all work, artwork, copy, posters, billboards, photographs, videotapes, audiotapes, systems designs, software, reports, designs, specifications, drawings, diagrams, surveys, source codes, professional or technical information or data, photographs, notes, letters, emails or any original works of authorship created by Professional or its subcontractors or subcontractors in connection with Services performed under this Agreement ("Products") shall be works for hire as defined under Title 17 of the United States Code, and all copyrights in such works are the property of District. In the event it is ever determined that any Product created by Professional or its subcontractors, or subcontractors under this Agreement, are not works for hire under U.S. law, Professional hereby assigns all copyrights to such Products to District. With the prior written approval of District's point of contact for the Project, Professional may retain and use copies of such Products for reference and as documentation of its experience and capabilities.

All Products shall become the property of District irrespective of where located or stored, and Professional agrees to deliver all such documents and information to District, without charge and in whatever form it exists, on the completion of the Professional's Services hereunder. Professional shall have no ownership interest in such Products.

All work product of Professional under this Agreement, including written information which District will cause to be distributed for either internal or public circulation, including both preliminary and final drafts, shall be delivered to District in both printed and electronic form, or as may be specified in **Exhibit A**.

Upon the conclusion of the Term or in the event of Termination, Professional agrees, at its expense and in a timely manner, to return to District all documents, drawings, photographs and other written or graphic material, however produced, that it received from District, its contractors, or agents, in connection with the performance of its Services under this Agreement. All materials shall be returned in the same condition as received.

Section 17. Assignment Prohibited. No Party to this Agreement may assign any right or obligation pursuant to this Agreement. Any attempt or purported assignment of any right or obligation pursuant to this Agreement shall be void and of no effect.

{CW021899.2}

Section 18. Excusable Delays; Notice to Other Party of Delay. Professional shall not be in breach of this Agreement in the event that performance of Services is temporarily interrupted or discontinued due to a “Force Majeure” event which is defined as: riots, wars, sabotage, civil disturbances, insurrections, explosion, natural disasters such as floods, earthquakes, landslides, fires, strikes, lockouts and other labor disturbances or other catastrophic events, which are beyond the reasonable control of Professional. Force Majeure does not include: (a) Professional’s financial inability to perform; (b) Professional’s failure to obtain any necessary permits or licenses from other governmental agencies; or (c) Professional’s failure to obtain the right to use the facilities of any public utility where such failure is due solely to the acts or omissions of the Professional.

Section 19. Suspension of Services by District. District reserves the right to suspend Professional's Services under this Agreement when District determines that it is necessary to do so. When possible, District shall give Professional notice of such suspension and Professional shall, upon receipt of said notice, suspend all Services except any Services, the completion of which is authorized by the notice given by District. If the Services are suspended by District for more than sixty (60) consecutive days, for reasons other than the fault of the Professional, the Professional shall be compensated for Services performed prior to notice of such suspension. When the Project is resumed, the Professional's compensation shall be equitably adjusted by District to provide for expenses incurred by the interruption of the Services. In this regard, Professional shall furnish to District such financial information that, in the judgment of the District Manager, is necessary to determine the reasonable value of the Services rendered by Professional during the period when Services were suspended.

If the Parties are unable to agree upon the amount of extra compensation which is due to Professional within thirty (30) days of Professional resuming Services, the amount of such additional compensation, if any, that is required to appropriately compensate the Professional for its expenses incurred by the interruption of Services may, upon the request of either Party, be determined by arbitration conducted in accordance with the “Arbitration of Disputes” section of this Agreement. Such arbitration shall be commenced by the Professional no later than sixty (60) calendar days following the event which entitles the Parties to pursue arbitration unless the Parties agree in writing to an extended time period for commencement of arbitration. Unless otherwise agreed in writing, all Parties shall carry on the Services and perform their duties during any arbitration proceedings, and District shall continue to make payments for the Services in progress as required by this Agreement.

Section 20. Termination of Work by District for Its Convenience. District shall have the right to terminate this Agreement at any time for its convenience by giving notice of such termination to Professional (“Termination”). In the event District shall give such notice of termination, Professional shall cease rendering Services upon receipt of said notice given as required in this Agreement. If District terminates this Agreement:

(a) Professional shall deliver copies of all Products prepared by it pursuant to this Agreement.

(b) If District terminates this Agreement for convenience before District issues the Notice to Proceed to Professional or before Professional commences any Services hereunder,

{CW021899.2}

whichever last occurs, District shall not be obligated to make any payment to Professional. If District terminates this Agreement after District has issued the Notice to Proceed to Professional and after Professional has commenced performance under this Agreement, District shall pay Professional the reasonable value of the Services rendered by Professional pursuant to this Agreement prior to termination of this Agreement. District shall not in any manner be liable for Professional's actual or projected lost profits had Professional completed the Services. Professional shall furnish to District such financial information that, in the judgment of the District Manager, is necessary to determine the reasonable value of the Services rendered by Professional prior to termination. In the event of a dispute as to the reasonable value of the Services rendered by Professional prior to termination and the Parties are unable to agree upon said amount within sixty (60) calendar days following the date of the notice of termination by District, such dispute may, upon the request of either Party, be resolved by arbitration conducted in accordance with the "Arbitration of Disputes" section of this Agreement.

(c) Except as provided in this Agreement, in no event shall District be liable for costs incurred by or on behalf of Professional after the date of the notice of termination.

(d) Notwithstanding this Section, this Agreement may be terminated by District for cause based on the loss or suspension of any licenses, permits or registrations required for the continued provision of the Services, or Professional's malfeasance. Termination of the Agreement for cause as set forth in this Section shall relieve District from compensating Professional.

Section 21. Assurance of Performance. If, at any time, District believes Professional may not be adequately performing its obligations under this Agreement or may fail to complete the Services as required by this Agreement, District may submit a written request to Professional for written assurances of performance and a plan to correct observed deficiencies in Professional's performance. Failure to provide written assurances subsequent to such written request, constitutes grounds to declare a breach under this Agreement.

Section 22. Cancellation for Breach by Either Party. Should either Party fail to substantially perform its obligations in accordance with the provisions of this Agreement, the other Party shall thereupon have the right to cancel the Agreement by giving written notice and specifying the effective date of such cancellation. If District cancels this Agreement for breach and it is subsequently determined that Professional did not fail to substantially perform its obligations in accordance with this Agreement, then cancellation for breach by District shall be deemed, and treated, as termination for convenience.

Neither Party waives the right to recover damages against the other for breach of this Agreement, including any amount necessary to compensate District for all detriment proximately caused by Professional's failure to perform its obligations hereunder or which in the ordinary course of things would be likely to result therefrom. District reserves the right to offset such damages against any payments owed to Professional.

District shall not in any manner be liable for Professional's actual or projected lost profits had Professional completed the Services required by this Agreement.

{CW021899.2}

Section 23. Arbitration of Disputes. All claims, disputes, and other matters in question between District and Professional arising out of or relating to this Agreement or the breach thereof, including claims of Professional for extra compensation for Services related to the Project, shall be decided by arbitration before a single arbitrator in accordance with the provisions of Sections 1281 to 1284.2 of the California Code of Civil Procedure (the “Arbitration Laws”) unless the Parties mutually agree otherwise. The provisions of Section 1283.05 of the Arbitration Laws apply to any arbitration proceeding except as otherwise provided in this Agreement. The arbitrator shall have authority to decide all issues between the Parties including, but not limited to, claims for extras, delay, and liquidated damages, if any, provided for in this Agreement, matters involving defects in the work product of the Professional, rights to payment, and whether the necessary procedures for arbitration have been followed. The award rendered by the arbitrator shall be final, and judgment may be entered upon it in accordance with applicable law in any court having jurisdiction thereof.

Notice of the demand for arbitration shall be filed in writing with the other Party. The demand for arbitration shall be made within a reasonable time after the claim, dispute, or other matter in question has arisen, and in no event shall it be made after the date when institution of legal or equitable proceedings based on such claim, dispute, or other matter in question would be barred by the applicable statute of limitation.

The Parties shall jointly appoint an arbitrator within fifteen (15) calendar days of the date of giving of the notice of the demand for arbitration. If the Parties are unable to jointly agree upon the appointment of an arbitrator within said fifteen (15) calendar day period, and do not agree in writing to extend said period for a fixed period, then either Party may seek to have the arbitrator appointed by the Superior Court of Santa Cruz County in accordance with the Arbitration Laws.

If any proceeding is brought to contest the right to arbitrate and it is determined that such right exists, the losing Party shall pay all costs and attorneys' fees incurred by the prevailing party.

In addition to the other rules of law which may be applicable to any arbitration hereunder, the following shall apply:

- (a) Promptly upon the filing of the arbitration, each Party shall be required to set forth in writing and to serve upon each other Party a detailed statement of its contentions of fact and law.
- (b) All parties to the arbitration shall be entitled to the discovery procedures as provided in Section 1283.05 of the California Code of Civil Procedure.
- (c) The arbitration shall be commenced and conducted as expeditiously as possible consistent with affording reasonable discovery as provided herein.
- (d) These additional rules shall be implemented and applied by the arbitrator.

{CW021899.2}

The costs of arbitration shall be borne by the Parties as determined by the arbitrator, but each Party shall bear its own attorney's fees associated with the dispute with the other Party and to the arbitration.

Section 24. Insurance Coverage. During the Term, the Professional shall maintain in full force and effect policies of insurance set forth herein, which shall be placed with insurers with a current A M Best's rating of no less than A VII and will provide District with written proof of said insurance. Professional shall maintain coverage as follows:

24.1. General Liability. Professional shall carry general liability insurance in the amount of Two Million Dollars (\$2,000,000.00) per occurrence for bodily injury, personal injury, and property damage. If commercial general liability insurance or another form with a general aggregate limit is used, either the general aggregate limit shall apply separately to this Project or the general aggregate shall be Two Million Dollars (\$2,000,000.00).

24.2. Workers' Compensation Insurance and Employer's Liability. Professional shall carry workers' compensation insurance as required by the State of California under the Labor Code. Professional shall also carry employer's liability insurance in the amount of One Million Dollars (\$1,000,000.00) per accident, with a One Million Dollar (\$1,000,000.00) policy limit for bodily injury by disease, and a One Million Dollar (\$1,000,000.00) limit for each employee's bodily injury by disease.

24.3. Errors and Omissions Liability. Professional shall carry errors and omissions liability insurance in the amount of no less than Two Million Dollars (\$2,000,000.00) per occurrence or greater if appropriate for the Professional's profession. Any deductibles or self-insured retentions must be declared to and approved by District. At the option of the District, either the insurer shall reduce or eliminate such deductibles or self-insured retentions with respect to the District, elected and appointed councils, commissions, directors, officers, employees, agents, and representatives ("District's Agents"); or the Professional shall provide a financial guarantee satisfactory to the District guaranteeing payment of losses and related investigations, claims administration and defense expenses.

24.4. Commercial Automobile Liability. Professional shall carry commercial automobile liability insurance in the amount of One Million Dollars (\$1,000,000) or greater per occurrence for owned, leased, hired, and borrowed automobiles.

24.5. Waiver of Subrogation. With the exception of errors and omissions liability insurance, Professional hereby agrees to waive subrogation which any insurer of Professional may acquire from Professional by virtue of the payment of any loss. The commercial general liability policy and workers' compensation policy shall be endorsed to contain a waiver of subrogation in favor of District for all work performed by Professional, its agents, employees, independent contractors, and subcontractors. Professional agrees to obtain any endorsement that may be necessary to affect this waiver of subrogation.

Section 25. Additional Insurance Requirements. Within five (5) days of the Effective Date, Professional shall provide District with certificates of insurance for all of the policies required

{CW021899.2}

under this Agreement (“Certificates”), excluding the required workers’ compensation insurance. Such Certificates shall be kept current for the Term of the Agreement and Professional shall be responsible for providing updated copies and notifying District if a policy is cancelled, suspended, reduced, or voided. With the exception of the workers’ compensation insurance, all of the insurance policies required in this Agreement shall:

(a) Provide that the policy will not be cancelled, allowed to expire, or materially reduced in coverage without at least thirty (30) days’ prior written notice to District of such cancellation, expiration, or reduction and each policy shall be endorsed to state such;

(b) Name District, and District’s Agents as additional insureds with respect to liability arising out of Services, work, or operations performed by or on behalf of Professional;

(c) Cover products and completed operations of Professional, premises owned, occupied, or used by the Professional, or automobiles owned, leased, or hired or borrowed by the Professional; contain no special limitations on the scope of protection afforded to District;

(d) Be primary with respect to any insurance or self-insurance programs covering District or District’s Agents and any insurance or self-insurance maintained by District or District’s Agents shall be in excess of Professional’s insurance and shall not contribute to it;

(e) Contain standard separation of insured provisions; and

(f) State that any failure to comply with reporting or other provisions of the policy including breaches of warranties shall not affect the coverage provided to District.

Section 26. Indemnification by Professional. To the fullest extent permitted by law (including, without limitation, California Civil Code sections 2782 and 2782.8), Professional shall defend with legal counsel reasonably acceptable to District, indemnify and hold harmless District and District’s Agents from and against any and all claims, loss, cost, damage, injury (including, without limitation, injury to or death of an employee of Professional or its subcontractors), expense and liability of every kind, nature and description that arise out of, pertain to, or relate to acts or omissions of Professional, or any direct or indirect subcontractor, employee, contractor, representative or agent of Professional, or anyone that Professional controls (collectively “Liabilities”). Such obligations to defend, hold harmless, and indemnify District and District’s Agents shall not apply to the extent that such Liabilities are caused in whole by the sole negligence, active negligence, or willful misconduct of District and District’s Agents, but shall apply to all other Liabilities. With respect to third party claims against the Professional, the Professional waives any and all rights of any type of express or implied indemnity against District and District’s Agents.

Section 27. Liability of District. Notwithstanding any other provision of this Agreement, in no event shall District be liable, regardless of whether any claim is based on contract or tort, for any special, consequential, indirect, or incidental damages, including, but not limited to, lost profits or revenue, arising out of or in connection with this Agreement or the Services performed in connection with this Agreement.

{CW021899.2}

Section 28. Independent Contractor. At all times during the Term, Professional shall be deemed to be an independent contractor and shall be wholly responsible for the manner in which Professional performs the Services required under this Agreement. Professional shall be liable for its acts and omissions and those of its employees, contractors, subcontractors, representatives, volunteers, and its agents. Nothing contained herein shall be construed as creating an employment, agency, or partnership relationship between District and Professional. District shall have the right to control Professional only insofar as the result of Professional's Services rendered pursuant to this Agreement; however, District shall not have the right to control the means by which Professional accomplishes Services rendered pursuant to this Agreement.

Section 29. Professional Not Agent. Except as District may specify in writing, Professional shall have no authority, express or implied, to act on behalf of District in any capacity whatsoever as an agent. Professional shall have no authority, express or implied, pursuant to this Agreement to bind District to any obligation whatsoever.

Section 30. Payment of Taxes and Other Expenses. Payment of any taxes, including California sales and use taxes, levied upon this Agreement, the transaction, or the Services or goods delivered pursuant hereto, shall be the obligation of Professional.

Section 31. Notices. Any notice or communication required hereunder between District and Professional must be in writing, and may be given either personally, by registered or certified mail (return receipt requested), or by Federal Express, UPS or other similar couriers providing overnight delivery. If personally delivered, a notice shall be deemed to have been given when delivered to the Party to whom it is addressed. Notices given by registered or certified mail shall be deemed to have been given and received on the first to occur of (a) actual receipt by any of the addressees designated below as the party to whom notices are to be sent, (b) on the date delivered as shown on a receipt issued by the courier, or (c) five (5) days after a registered or certified letter containing such notice, properly addressed, with postage prepaid, is deposited in the United States mail. If given by Federal Express or similar courier, a notice or communication shall be deemed to have been given and received on the date delivered as shown on a receipt issued by the courier. Any Party hereto may at any time, by giving ten (10) days written notice to the other Party hereto, designate any other address in substitution of the address to which such notice or communication shall be given. Such notices or communications shall be given to the Parties at the addresses in this paragraph set forth below:

If to District:

**San Lorenzo Valley Water District
Attn: Brian Frus, Interim General Manager
13060 Highway 9
Boulder Creek, CA 95006**

With courtesy copies to:

**White Brenner LLP
Attn: Barbara A. Brenner
1414 K Street, 3rd Floor
Sacramento, CA 95814**

{CW021899.2}

If to Professional:

Navigating Preparedness Associates
Attn: Lee Rosenberg
3245 Driftwood Dr.
Lafayette, CA. 94549

Section 32. Exhibits. All “Exhibits” referred to below or attached to herein are by this reference incorporated into this Agreement:

<u>Exhibit Designation</u>	<u>Exhibit Title</u>
Exhibit A:	Services

Section 33. General Provisions.

a. Modification. No alteration, modification, or termination of this Agreement shall be valid unless made in writing and executed by all Parties.

b. Waiver. No covenant, term, or condition or the breach thereof shall be deemed waived, except by written consent of the Party against whom the waiver is claimed, and any waiver of the breach of any covenant, term, or condition shall not be deemed to be a waiver of any preceding or succeeding breach of the same or any other covenant, term, or condition.

c. Assignment. No Party shall assign, transfer, or otherwise dispose of this Agreement in whole or in part to any individual, firm, or corporation without the prior written consent of the other Party. Subject to the forgoing provisions, this Agreement shall be binding upon, and inure to the benefit of, the respective successors and assigns of the Parties.

d. Governing Law. This Agreement shall be governed by and construed in accordance with the laws of the state of California.

e. Venue. Venue for all legal proceedings shall be in the Superior Court of California for the County of Santa Cruz.

f. Counterparts. This Agreement may be executed in two or more counterparts, each of which shall constitute an original and all of which shall be deemed a single agreement.

g. Severability. If this Agreement in its entirety is determined by a court to be invalid or unenforceable, this Agreement shall automatically terminate as of the date of final entry of judgment. If any provision of this Agreement shall be determined by a court to be invalid and unenforceable, or if any provision of this Agreement is rendered invalid or unenforceable according to the terms of any federal or state statute, which becomes effective after the Effective Date of this Agreement, the remaining provisions shall continue in full force and effect and shall be construed to give effect to the intent of this Agreement.

{CW021899.2}

h. Audit. District shall have access at all reasonable times to all reports, contract records, contract documents, contract files, and personnel necessary to audit and verify Professional's charges to District under this Agreement.

i. Entire Agreement. This Agreement sets forth the entire understanding between the Parties as to the subject matter of this Agreement and merges all prior discussions, negotiations, proposal letters or other promises, whether oral or in writing.

j. Supersedes Prior Agreement. It is the intention of the Parties hereto that this Agreement shall supersede any prior agreements, discussions, commitments, or representations, whether written, electronic or oral, between the Parties with respect to the subject matter of this Agreement.

k. Headings Not Controlling. Headings used in this Agreement are for reference purposes only and shall not be considered in construing this Agreement.

l. Successors and Assigns. All representations, covenants, and warranties specifically set forth in this Agreement, by or on behalf of, or for the benefit of, any or all of the Parties hereto, shall be binding upon and inure to the benefit of such Party, its successors and assigns.

m. Interpretation. As used herein, any gender includes each other gender, the singular includes the plural and vice versa.

n. Mandatory and Permissive. "Shall" and "will" and "agrees" are mandatory. "May" and "can" are permissive.

o. Attorney's Fees and Costs. If any action at law or in equity not resolved pursuant to the "Arbitration of Disputes" section of this Agreement, including action for declaratory relief, is brought to enforce or interpret provisions of this Agreement, the prevailing Party shall be entitled to reasonable attorney's fees and costs, which may be set by the court in the same action or in a separate action brought for that purpose, in addition to any other relief to which such Party may be entitled.

p. Successors and Assigns. All representations, covenants, and warranties specifically set forth in this Agreement, by or on behalf of, or for the benefit of, any or all of the Parties hereto, shall be binding upon and inure to the benefit of such Party, its successors and assigns.

q. Time is of the Essence. Time is of the essence in this Agreement for each covenant and term of a condition herein.

[Signatures on Following Page]

{CW021899.2}

IN WITNESS WHEREOF, the Parties have executed this Agreement as of the last day and date below written.

DISTRICT:

SAN LORENZO VALLEY WATER
DISTRICT, a California County Water District

By: _____
Brian Frus, Interim General Manager

Date: _____

PROFESSIONAL:

Navigating Preparedness Associates, a
California Limited Liability Corporation

By: _____

Name: _____

Date: _____

Approved as to Form:

Barbara A. Brenner, General Counsel

EXHIBIT A
Scope of Services



2024

Local Hazard Mitigation Plan



PREPARED FOR:
SAN LORENZO VALLEY WATER DISTRICT

PREPARED BY:
NAVIGATING PREPAREDNESS, LLC.

FEBRUARY 28, 2024



1. COVER LETTER

February 28, 2024

San Lorenzo Valley Water District
Attn: Carly Blanchard, Environmental Program Manager
13060 Highway 9
Boulder Creek, CA 95006

RE: Proposal in Response to RFP to provide San Lorenzo Valley Water District Local Hazard Mitigation Plan

Dear Carly Blanchard and Members of the Selection Committee:

Navigating Preparedness Associates (NPA) is pleased to provide this proposal to the San Lorenzo Valley Water District (SLVWD or District) to assist in the Local Hazard Mitigation Plan (LHMP) development in the District's Sphere of Influence. NPA is a Limited Liability Corporation (LLC) established in March 2014. We are a California Certified Service-Disabled Veteran-Owned Small Business Enterprise (SDVBE), CA Department of General Services (DGS) #1770371.

Over the past 10 years, NPA has supported development of and updates to LHMPs for special districts, tribes, cities, and counties. Our clients have developed a deep sense of trust in our ability to provide them with exceptional value and have rewarded us with multiple subsequent projects. NPA provides a focused approach to LHMP projects. We assign senior, experienced consultants at extremely competitive billing rates. We can produce a superior product in less time, with a smaller budget and better results than many larger firms. Our planners thoroughly understand Title 44 CFR §201.6, DMA 2000, and the Federal Emergency Management Agency (FEMA) Local Hazard Mitigation Plan Review Guide and approval process.

NPA recommends that the update to the LHMP be organized into seven phases to meet the planning requirements of the Local Hazard Mitigation Plan Review Guide. NPA will work with the assigned SLVWD Project Manager and the Hazard Mitigation Planning Team to make sure the phases are accomplished with little disruption to staff's day to day duties, while accommodating the needs of the District.

Sincerely,



Lee Rosenberg, CEM, Managing Director

2. PROJECT UNDERSTANDING, APPROACH, AND SCHEDULE`

Our team understands that LHMPs require an extensive and closely reviewed planning process that must include participation by internal and external stakeholders, businesses, and community members. The Scope of Work shall include a minimum of seven phases to ensure the plan is developed to meet the expectations of the Federal Emergency Management Agency, SLVWD, and community members. Figure 1 depicts the seven phases that will be used in the development of the LHMP.



Figure 1: Seven Phases to LHMP Development

A detailed outline of how NPA will approach the seven phases can be found below.

PHASE 1: PLANNING PROCESS

SLVWD Planning Team Development – NPA in conjunction with the District Project Manager, will develop a Hazard Mitigation Planning Team (HMPT) which will consist of District staff, staff from local, state, and federal agencies, and community representatives that encompass the whole community approach to planning. We will guide the HMPT through the planning process to ensure the objectives of the LHMP are met.

Planning Process Documentation – NPA will prepare, organize, and maintain documentation that memorializes the entire planning process, informs the public and stakeholders of the overall approach, and serves as permanent record as to the plans development, public involvement,

and decisions made. NPA understands the importance of ensuring all documentation is collected and available for submission to CalOES and FEMA to ensure grant funding.

Public Outreach Strategy – NPA will develop and implement a public outreach strategy which conforms to the statutory requirements of the Code of Federal Regulations 44 CFR 201.6, the requirements of FEMA Local Mitigation Plan Guidelines, and the Community Rating System (CRS) program.

Document, Evaluate, and Incorporate Input – As data is gathered, conclusions are reached, or recommendations are created, NPA will develop detailed notes and a comments matrix to catalog all input received from the Planning Team, County, and community members. NPA will ensure all relevant input is incorporated, fill in gaps, ensure consistency, and perform quality control/assurance checks.

Public Outreach Workshops – NPA will facilitate a minimum of two public outreach workshops that will focus on educating the public about the LHMP development process and identifying community concerns. This will provide an opportunity for the public to interact with the LHMP Planning Team, introduce the public to the progress and outcomes of the LHMP planning process, review outcomes, and function as a public commenting tool. NPA will develop social media content to inform the community about plan development, and a press release for public comment period.

Board of Directors Presentations (2) – Similar to the Public Outreach Workshops, NPA will present the plan to the SLVWD Board of Directors to provide another avenue to obtain feedback from the Board and the public.

County-wide Participation – During the planning process, and while the planning team is being developed, NPA and the Planning Team will identify neighboring communities, local and regional agencies involved in hazard mitigation activities, agencies that have authority to regulate development, and others with interested in reviewing and providing input to the plan to ensure they are provided an opportunity to provide input.

Project Management – NPA employs a systematic and comprehensive project management process for the entire project. At the start of the project NPA will develop a project workplan and operations road map. This will include project/task timeline, milestones, detailed budget, and accounting procedures.

PHASE 2: HAZARD IDENTIFICATION

NPA will review County and State resources and work with the planning team to Identify hazards which will include a description and prioritization of the hazards that have occurred or have the potential to occur within the San Lorenzo Valley Water District's jurisdiction.

Hazard Identification and Profiles – The Hazard Identification and Profiles section will provide a description and prioritization of the hazards that have occurred or have the possibility to impact within the District’s boundaries. The hazards will be ranked using the Calculated Priority Risk Index (CPRI) which examines four criteria for each hazard (probability, magnitude/severity, warning time, and duration) to determine how each hazard can impact the District. NPA along with the HMPT will review the identified hazards to ensure prioritization is accurate and identify additional hazards that may be of concern.

PHASE 3: RISK ASSESSMENT

Hazard Mapping – Using the best available data, the risk assessment will include hazard and infrastructure maps that will be provided by NPA that delineate areas affected by hazards and identify locations of local assets. NPA will take the existing data and ensure new developments and infrastructure are overlaid with new hazard maps. The geographic information data will comprise a comprehensive inventory for use in developing map data layers of the following items relative to the multiple hazard area: Operational and Public Buildings, Critical Facilities and Infrastructure, and Maps of location of Parcels, Structures, Land Use, and Population.

Vulnerability Assessment – Based on the profiled hazards and the hazard mapping, NPA will develop an overview of the District’s vulnerability to specific hazards and will create Digital maps and GIS data to identify local assets that are located within known hazard areas. HAZUS will be used to model losses as appropriate. Depending on the data available, the vulnerability assessment will include:

- Types and numbers of buildings, infrastructure, and critical facilities located within the planning area and within identified hazard areas.
- Potential economic losses from identified hazards will be estimated through the process that utilizes HAZUS-MH or GIS analysis of County Assessor’s data with hazard locations.
- Description of land uses and development trends to advise future land use decisions.

Capability Assessment – A capability assessment will be conducted that will inventory those existing plans, policies, and procedures that the District has in place to reduce the effect of hazards. This will include protective measures under the National Flood Insurance Program (NFIP), building codes, zoning ordinances, completed or ongoing mitigation projects, mitigation policies, established in the genal or comprehensive plans of other jurisdictions. In conducting the capability assessment, the areas that will be examined include but are not limited to:

- Identify and evaluate vulnerable assets and estimate loss potential of those assets.
- Describe natural, technological, and/or human caused hazards that have potential to affect the SLVWD’s assets.



- For each hazard affecting the planning area, prepare a description of geographic location, extent, previous occurrences, and probability of future events.
- Identify addresses of NFIP insured structures that have been repetitively damaged by floods.
- Review existing studies, reports, and plans
- related to historical disasters, and document disaster declaration history.
- Utilize FEMA’s Hazus, RiskMAP products (and/or other appropriate software) to generate level 2 vulnerability assessments for earthquake and fire hazards.
- Develop a parcel-level inventory of vulnerable structures.

PHASE 4: MITIGATION STRATEGY

NPA will work with the HMPT to create a mitigation strategy that addresses identified hazards with the goal of reducing or avoiding long-term vulnerabilities.

Mitigation Action Development – Developing a comprehensive range of specific mitigation action items being considered to reduce the effects of each hazard, based on the risk assessment. The mitigation strategy will include:

- Mitigating losses for new and existing buildings and infrastructure and for future development areas.
- A list of prioritized hazard mitigation action items that best meet the District’s needs for hazard damage reduction.
- Prioritization factors with an analysis of proposed mitigation projects focused on several key areas, including but not limited to economic (including benefits and cost), engineering, technical, legal, environmental, social, and political feasibility.
- Identifying mitigation actions for which no current or planned funding mechanisms are available.

Mitigation Action Implementation – While the planning process is important in creating and updating the LHMP, the real value is in implementing an actionable document that leads to reduced risk. To this end, NPA will identify how each mitigation action will be implemented, including who is responsible for various actions, funding mechanisms, timeframe for implementation, and implementation priority.

Mitigation Action Matrix – NPA will prepare a matrix that summarizes mitigation actions, priority, responsible party or parties, funding mechanisms, benefit/cost, and technical feasibility.

PHASE 5: PLAN PREPARATION AND DRAFTING

The plan preparation and drafting phase will have four primary objectives:

1. Compile all data into a draft Local Hazard Mitigation Plan that meets all of FEMA's criteria.
2. Submit an administrative draft to the District for review and incorporate feedback into the draft to prepare for public review and comment.
3. Incorporate public review comments and submit a draft LHMP to Cal OES State Hazard Mitigation Officer (SHMO) for review and comment.
4. Incorporate comments from Cal OES/SHMO and submit a final draft LHMP through Cal OES to FEMA for review and comment.

PHASE 6: PUBLIC OUTREACH, MEETINGS, AND PUBLIC COMMENT

The public will be engaged at all stages of the planning process - from plan review through adoption of the LHMP. Initial public engagement will utilize online outreach and direct public outreach to assess community perspectives of local hazards and concerns. NPA will be responsible for the following tasks to meet the public outreach, meetings, and public comment objectives through development of a public outreach strategy:

- Conform to the statutory requirements of the Code of Federal Regulations 44 CFR 201.6, the requirements of FEMA Local Mitigation Planning Handbook, and the Community Rating System (CRS) program.
- Document, evaluate and incorporate input received from outreach efforts.
- Organize, assist in noticing and facilitate a minimum of two (2) public outreach workshops.
- Present at a minimum of two (2) Board of Directors or Environmental and Engineering Committee meetings (which may coincide with public outreach workshops).
- Ensure neighboring communities, local and regional agencies involved in hazard mitigation activities, agencies that have the authority to regulate development, and other relevant interests participate in the planning process as required by 44 CFR 201.6 (b)(2).

PHASE 7: PLAN APPROVAL AND ADOPTION

LHMP Adoption and Approval – Following the plan preparation and drafting phases of the LHMP, NPA will assist SLVWD staff with final adoption procedures by the San Lorenzo Valley Water District's Board of Directors and incorporate adoption in the final LHMP. Once the LHMP plan is finalized, NPA will secure final approval letter and plan review tool from FEMA.

During this phase, the NPA will ensure the plan and planning process are completed to the satisfaction of, and in accordance with the criteria established by, FEMA. NPA will strive to

ensure no additional revisions will be needed once submitted, but if needed, NPA will be responsible for all plan revisions from FEMA and CalOES, until the Board of Directors adopt it.

PROJECT SCHEDULE

NPA proposes a seven-month timeline to submit the LHMP to CalOES and FEMA from the Notice to Proceed. Once submitted to CalOES and FEMA, the review period can take anywhere from three to six months depending on their current workload. Scheduled events may vary based upon District staff availability, timeliness of CalOES and FEMA review and unforeseen events.

Proposed Schedule							
Task/Month	Month 1	Month 2	Month 3	Month 4	Month 5	Month 6	Month7
Project Management	Kick-off Meeting	Progress Reports	Progress Reports	Progress Reports	Progress Reports	Progress Reports	Progress Reports
Phase 1: Planning Process	Kickoff Meeting	Planning Meeting	Planning Meeting		Planning Meeting		
Phase 2: Hazard Identification		Survey Results					
Phase 3: Risk Assessment		Hazus / GIS	Capabilities				
Phase 4: Mitigation Strategy			Objectives	Mitigation Activities Priorities			
Phase 5: Plan Preparation/ Drafting				Initial Draft			
Phase 6: Public Outreach/Public Comment		Survey	Outreach Meetings		Public Review Draft		
Phase 7: Plan Approval/ Adoption						FEMA Review Draft	Adoption

3. BUDGET

NPA proposes to complete the scope of work including optional tasks for a fixed, firm fee of \$43,500. We do not markup expenses or other direct costs. The table below contains a breakdown of tasks, and estimated labor hours by staff billing rate, and other costs.

We propose to invoice monthly with payment due at net 30 days. Statements will contain detailed accounts of labor hours by staff and other direct costs. POV travel will be billed at the current Federal Acquisition Rules rates. Each statement will provide a narrative of work completed, budget status, and any areas of concern.

Earned Value Management:

NPA uses earned value management (EVM) techniques for measuring project performance and progress in an objective manner. EVM provides the capability to combine measurements of the project management triangle: scope, time, and costs in a single integrated system. Use of EVM on past projects has resulted in NPA never exceeding budget.

San Lorenzo Water District LHMP	Rate	Task 1: Planning Process	Task 2 Hazard Identification	Task 3: Risk Assessment	Task 4: Mitigation Strategy	Task 5: Plan Preparation	Task 6: Public Outreach / Comment	Task 7: Plan Approval	Total Hours
Job Title									
Project Manager - Lee Rosenberg	180	10	8	8	5	10	22	12	75
Senior Planner - Francisco Soto	125	15	38		18	40	10	8	129
GIS Planner - Aaron Cole	130			48	12	6			66
QA/QC Crystal Stueve	145	4	5	6	6	8	2	2	33
ODCs									
Material							220		220
Travel		170					120		170
Total ODCs		170	-	-	-	-	340	-	510
Total Hours		29	51	62	41	64	34	22	303
Labor Cost		4,255	6,915	8,550	5,580	8,740	5,500	3,450	
Labor + ODCs		4,425	6,915	8,550	5,580	8,740	5,840	3,450	\$43,500



4. FIRM QUALIFICATIONS, TEAM ORGANIZATION, EXPERIENCE AND CERTIFICATION/QUALIFICATIONS

NPA is a Limited Liability Corporation (LLC) established in March 2014 and has been in business continuously for over 9 years. We are a California Certified Service-Disabled Veteran-Owned Small Business Enterprise (SDVBE), CA Department of General Services (DGS) #1770371. Our first client was the Port of Oakland, followed by the San Francisco Bay Ferry. From a boutique firm providing maritime homeland security and disaster response operational planning, NPA has diversified to deliver a broad range of emergency preparedness solutions but specializing in Local Hazard Mitigation Plans. We have grown year over year since inception. Financial information is available upon request.

Key Information about Navigating Preparedness can be found below.

Legal Name:	Navigating Preparedness Associates, LLC
Physical and Billing Address:	3245 Driftwood Dr. Lafayette, CA. 94549
Phone:	925-381-0583
Website:	www.navigatingpreparedness.com
Federal I.D. Number:	46-5133958
DUNS Number:	079966673
Person to Represent the Company:	Lee Rosenberg, Managing Director lee.rosenberg@navigatingpreparedness.com

PREVIOUS PERFORMANCE

Prior to establishing NPA, Mr. Rosenberg managed United Research Services (URS) Corporation's Environmental Services Department in their Oakland office for over six (6) years. He supervised over 40 staff including LHMP planners and a large GIS group. While at URS, he was project manager for LHMP updates for Mendocino County, Mariposa County, Solano County, Ventura County, Clark County, NV., and the Territory of Guam.

Since Establishing NPA, we have delivered numerous LHMPs for clients. We have successfully led the development of over twenty (20) LHMPs over the past nine (9) years. We have supported other consulting firms with many additional plans. Section 4 of the proposal lists various LHMP projects our firm has led.

PRESENT WORKLOAD

NPA has a deep bench of associates that can devote the time necessary to complete this project given the proposed timeline. Additionally, our proposed subcontractor has additional staff with LHMP experience that can provide value to the project, if needed.

ABILITY TO PERFORM SCOPE OF SERVICES

NPA is confident that it can complete the Scope of Services described in the proposal. Although we have proposed a sub-consultant to assist, NPA has the staff to complete the scope of work if unforeseen circumstances arise.

STABILITY OF FIRM

NPA was established in March 2014 and has been in business continuously for over nine years. We have grown year over year since inception. Financial information is available upon request.

PROJECT ORGANIZATION CHART

Our entire proposed project organization is contained in the following organization chart.

San Lorenzo Valley Water District Local Hazard Mitigation Plan

ORGANIZATIONAL CHART

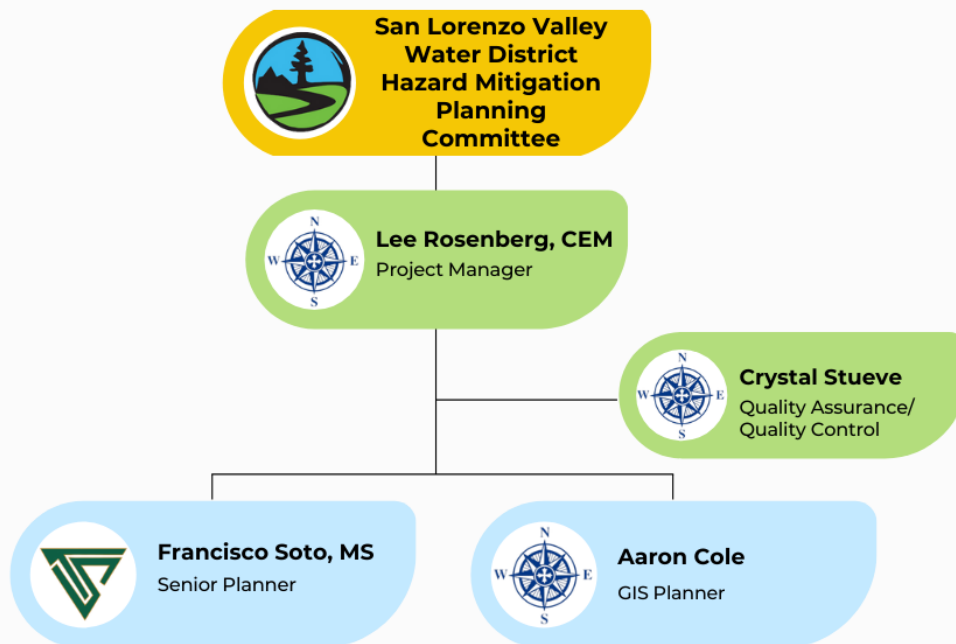

EXPERIENCE AND QUALIFICATION OF KEY PERSONNEL

Our staff have a vast amount of experience developing LHMPs and in emergency management. NPA proposes the following team of key professionals and organizations to support the San Lorenzo Valley Water District LHMP development project.

Lee Rosenberg – Project Manager

Mr. Rosenberg is a Certified Emergency Manager and holds a degree in Engineering Management from Northwestern. He is a member of the International Association of Emergency Managers and the California Emergency Services Association. Mr. Rosenberg has supported LHMP development and updates for over twelve (14) years and has supported mitigation program management for over fifteen (18) years.

Francisco Soto – Senior Planner/HMP Subject Matter Expert

Mr. Soto has over ten (10) years of experience in Emergency Management and holds a **master's degree in emergency services**. He has served as the Project Manager and Senior Planner for various hazard mitigation plans, other emergency planning documents, training, and exercise projects. Mr. Soto worked as a consultant where he led the development of the HMP for the cities of Hermosa Beach, Manhattan Beach, and Palos Verdes Estates, in addition to various other emergency plans and exercises. He has worked for the Municipal Water District of Orange County and City of Long Beach where he was the project manager for the LHMP and Emergency Operations Plan update, and various other documents.

Aaron Cole – GIS Planner

Mr. Cole (GISP): Has supported complex data management and geospatial analysis projects for over 12 years. His skills include Python application development, web application development, GIS and remote sensing analysis, cartographic design, small-scale to enterprise-level database design and administration.

Full resumes of key proposed staff are contained in Appendix 1.

5. PAST PROJECT PERFORMANCE

The NPA Team has delivered numerous LHMPs for clients. Information on a sample of our water agency performance with contact information can be found below. Each of these projects was led and primarily authored by Lee Rosenberg.

Client 1: East Valley Water District

Project Title: Emergency Preparedness Plan Analysis and EOC SOP Development

Timeline: September 2023 – Current

Budget: \$41,000

Client Location: 31111 Greenspot Rd, Highland, CA 92346

Client Point of Contact:

Name:	Kerrie Bryan
Title:	Director of Admin Services
Email:	kbryan@eastvalley.org
Phone:	C: (909) 806-4087 O: (909) 889-9501

Role Assigned:

- Prime Consultant
- Lee Rosenberg: Project Manager, Lead planner
- Francisco Soto: Senior planner

Project Outcome

- Assessed the District’s emergency preparedness program including the LHMP, RRA and ERP and provided recommendations report for 2023.
- Updating the EOC SOP (2024).

Client 2: VALLEY COUNTY WATER DISTRICT

Project Title: LHMP Update and Grant Application Support

Timeline: 2020-2022

Budget: \$107,500

Client Location: 5121 Lante St, Baldwin Park, CA 91706

Client Point of Contact:

Name:	Tara Robinson
Title:	Management Analyst
Email:	trobinson@vcwd.org
Phone:	C: (818) 428-6981

Role Assigned:

Prime Consultant

Lee Rosenberg: Project manager, Lead planner

Aaron Pfannenstiel: Hazard analysis

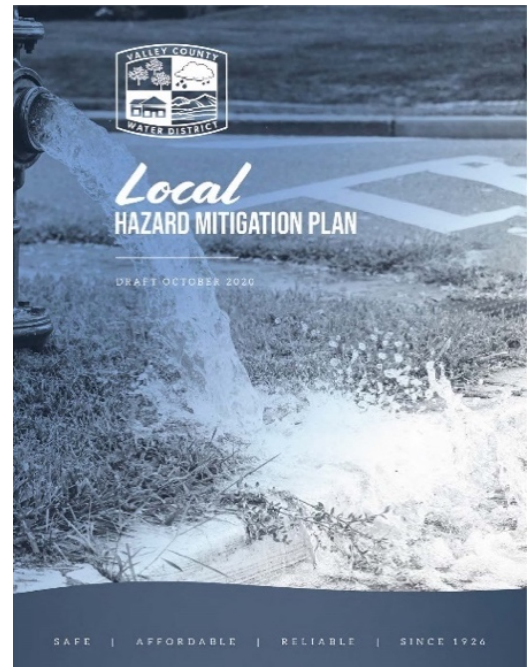

Project Outcome

- NPA recently completed a project to support VCWD revise their 2012 LHMP. The result was a complete rewrite of the plan. The LHMP was found approvable by FEMA and adopted by the District Board of Directors in March 2021.
- NPA also led a project to support a FEMA grant application. Directed a seismic analysis of the District plant. Led development of the grant technical analysis and benefit cost analysis.
- The District was immediately able to receive \$350K in funding from approved PDM grant for an emergency diesel generator fuel tank. Applied for and received an HMGP grant to support a \$11.4M to construct 2 additional 2M gallon steel reservoirs.

Client 3: Valley Water (Santa Clara Valley Water District)

Project Title: FERC Dam Emergency Action Plan Exercise Series, Temporary Construction Dam Emergency Action Plan and Exercise, 12 Dam Emergency Action Plans

Timeline: April 2016 – Current

Budget: \$328,500

Client Location:

Client Point of Contact:

Name:	Nina Merrill
Title:	Program Administrator Dam Safety
Email:	nmerrill@valleywater.org
Phone:	W: (408) 630-2640

Role Assigned:

Prime Consultant

Lee Rosenberg: Project manager, Lead planner

Francisco Soto: Senior planner

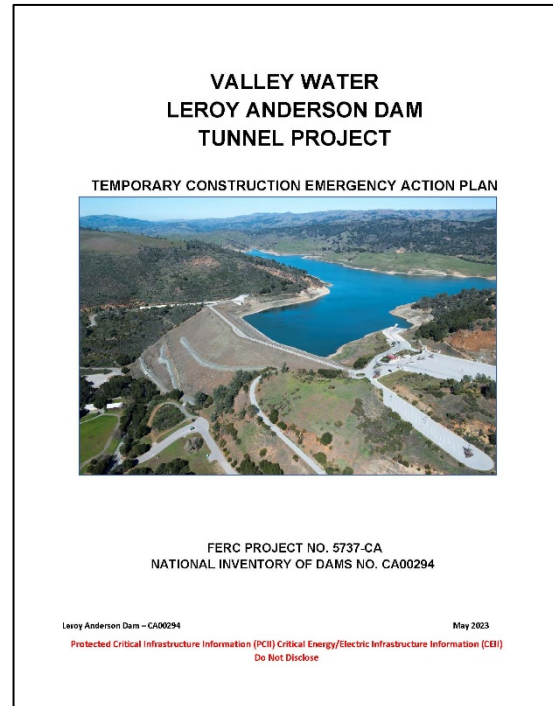

Project Outcome

- Led design and development of a series of exercises to support FERC compliance for Anderson Dam. The series included a seminar, communications drill, TTX and functional exercise.
- Developed 12 dam emergency action plans (EAP) to meet Cal OES regulatory requirements. (Project ongoing)
- Developed a temporary construction dam EAP for a dam seismic retrofit. The EAP was FERC approved. Designed and delivered a TTX to validate the EAP and provide familiarity with the plan for construction managers.

6. SUB-CONSULTANT QUALIFICATIONS

Supporting Navigating Preparedness in this effort is Tandem Solutions, LLC. (Tandem), a small, minority woman owned business based in Artesia, California. Tandem staff have over 25 years of experience in Emergency Management. Their team has experience in special districts, government, higher education, and transportation emergency management programs, and have led updates to LHMPs, Emergency Operations Plans, and various other emergency planning documents for small and large jurisdictions, including multiple water districts. Tandem staff previously worked for the Municipal Water District of Orange County where they developed a Multi-Jurisdictional Hazard Mitigation Plan. Additional information about Tandem is located at: tandemsolutionsusa.com

NPA has collaborated with Tandem staff for over 7 years on a variety of projects, including Hazard Mitigation Plans, Emergency Operations Plans, and Standard Operating Procedures. Together, our team will provide SLVWD with a detailed, operational plan that addresses the needs of the District, its communities, and serviced water systems.

Key Information about Navigating Preparedness can be found below.

Legal Name:	Tandem Solutions, LLC
Physical and Billing Address:	17616 Summer Ave. Artesia, Ca 90701
Phone:	323-605-4200
Website:	tandemsolutionsusa.com
Person to Represent the Company:	Francisco Soto, Managing Director Francisco@tandemsolutionsusa.com

ABILITY TO PERFORM THE SCOPE OF SERVICES

Tandem has various staff with LHMP and other emergency plan development experience. Prior to establishing Tandem, Francisco Soto, Director of Tandem, worked for a consulting firm where he was the Project Manager for LHMP projects for the cities of Hermosa Beach, Manhattan Beach, and Rancho Palos Verdes Estates.

EXTENT OF SUBCONTRACTING OF WORK

As part of this planning effort, Tandem staff will support NPA with plan writing, public outreach strategy, and mitigation action strategy.

PREVIOUS EXPERIENCE AND PROJECTS

Tandem staff has led project development for various emergency planning efforts. To include:

- Municipal Water District of Orange County LHMP – included thirty-four (34) Water and

Wastewater Agencies

- City of Long Beach LHMP and Emergency Operations Plan Development
- East Valley Water District Emergency Management Program Review and Standard Operating Procedures Development.
- Castro Valley Sanitary District Emergency Operations Plan and Standard Operating Procedures Development.
- Los Angeles County Coroner Mass Fatality Plan
- City of Pasadena Mass Fatality Plan and Alternate Care Site Annexes.

PRESENT WORKLOAD

NPA leads or provides support to between 6 and 8 LHMP projects annually. We have completed complex, multijurisdictional LHMPs for counties, cities and special districts including water districts. We have led complex projects for large water districts such as Valley Water (formerly Santa Clara Valley Water District) and been awarded follow on work due to the quality of our products.

NPA and Tandem are confident that we can deliver the LHMP in the proposed timeframe. Our staff have worked together closely for over 7 years. In addition to the staff showcased in this proposal, we have a deep bench of skilled LHMP planners. We never over promised and under delivered.

7. PROJECT MANAGEMENT PLAN

NPA employs a systematic and comprehensive project management process for the entire project. At the start of the project NPA will develop a project workplan and operations road map.

Operations - The operations roadmap will include a detailed task schedules that demonstrate the overall work approach within the critical path; an achievable, realistic schedule for each task and a means for proactively addressing potential delays; and a task-specific organization chart that defines the key positions and an effective staffing plan.

Budget - Upon the Notice to Proceed (NTP), NPA will develop a plan to monitor the project budget and schedule. A detailed estimate of progress made during each reporting period will be used to prepare status reports which will be reviewed during bi-weekly meetings to determine if we are within the approved budget and forecast schedule. If we find that either one of those indicators is compromised, the Project Manager will take corrective measures and adjust resources, as necessary. If there is a change in scope, NPA will closely communicate with the District's Project Manager and work together to mitigate impacts.

Communications - NPA recommends bi-weekly calls between Lee Rosenberg of NPA (Project Manager) and the District's Project Manager to discuss progress and address any concerns that may arise. We will provide written monthly progress reports to the District detailing accomplished actions, pending action items, and project challenges.

At the beginning of the project, we will:

- Confirm the individual(s) who will communicate between NPA and the District
- Identify the project team members who are authorized to submit requests for data, meetings, or other information.
- Describe how communication records shall be prepared and maintained.
- Identify confidentiality requirements and restrictions.

NPA recommends holding bi-weekly meetings with the District's Project Manager and select staff to discuss project status, potential project constraints, and opportunities in addition to agenda items dealing with project schedule, budget status, and potential scope creep.

Quality Assurance - Although all team members are cognizant and responsible for the quality of their work, we will ensure that District's quality standards are met by:

- Assigning a Quality Control Manager.

- The Project Manager will schedule a planning review with the District to discuss and verify that contractual, business, and management issues have been adequately prepared and planned for prior to beginning project execution.
- Risk assessments will be performed from the project development stage through the full execution of the project. Mitigation plans are developed and reviewed with senior management for project tasks with identified elevated risks.

Project reviews occur throughout project execution to facilitate communication between the Project and the project team. The status of the project is discussed along with areas where actions are required.

APPENDIX 1: RESUMES



LEE ROSENBERG, CEM – PROJECT MANAGER

PROFESSIONAL SUMMARY

Lee Rosenberg is the owner and managing director of Navigating Preparedness Associates, a disabled veteran business enterprise. As leader of the company, he provides comprehensive emergency preparedness services to industry. With more than 30 years of experience in national security, homeland security and emergency management,

Mr. Rosenberg led the URS Corporation’s Oakland environmental service department and West Coast emergency preparedness practice from 2006 to 2014. In addition, he served as a Federal Coordinating Officer for FEMA Region IX from 2004 to 2006 where he provided support to states for numerous presidentially declared disasters. Prior to working for FEMA, Mr. Rosenberg completed a 30-year career in the Navy during which he served as the commanding officer of a destroyer, USS Elliot (DD-967) and as the commander of a large amphibious assault hovercraft base. He is a combat veteran of Operation Desert Storm and retired as a Captain.

EXPERTISE:

- Certified Emergency Manager (IAEM)
- California County hazard mitigation plan development and updates
- Mitigation grant applications
- Hazard analysis and risk assessments
- Interagency and multi-stakeholder facilitation and coordination
- Emergency preparedness training and HSEEP compliant exercises
- Emergency operations planning and guidance development
- Over 30 years of operational response experience
- Continuity of operations planning

WORK EXPERIENCE

Coconino County, Arizona Multi-Jurisdiction Local Hazard Mitigation Plan, Flagstaff, AZ, 2020 – 2021. Lead Planner - Led all technical aspects to update the Clark County MJLHMP. Included innovative data analysis and GIS products. Managed a complex group of stakeholders from five incorporated cities and towns.

Valley County Water District, Local Hazard Mitigation Plan Update, Baldwin Park, CA 2020. Project Manager and Lead Planner – Updated the 2008 District LHMP on an expedited basis to support application for an approved mitigation project to install a large diesel storage tank which will improve the water distribution system’s resiliency. The LHMP planning and draft document development processes were completed in two months. Follow-on work to conduct a seismic analysis and support a grant application was contracted.

Tulare County, Multi-jurisdiction Local Hazard Mitigation Plan Update, Visalia, CA, 2016 – 2018. Project Manager and Lead Writer - Led a team to update the Tulare County MJLHMP. Included innovative data analysis and GIS products. The updated LHMP included eight cities, the Tulare County Office of Education and the Tule River Indian Tribe. Met the mandates of AB

2140 and SB 379. Found adoptable by FEMA RIX with minimal comments and adopted by the County Board in March 2018.

San Francisco Bay Water Emergency Transportation Authority (WETA), Hazard Mitigation Plan Update, San Francisco, CA. 2016 – 2017. Project Manager and Lead Planner - Led a multi-disciplinary team to create a unique LHMP for WETA. As a State mandated emergency transportation authority and a transit operator, WETA provides ferry service throughout the Bay Area. The LHMP involved close coordination with four Operational Areas and several cities. The HMP was adopted by the WETA board in May 2017.

2008 – 2014: URS Corporation, Environmental Department Manager/West Coast Region Emergency Management Practice Area Leader:

Clark County, Nevada Multi-Jurisdiction Local Hazard Mitigation Plan, Las Vegas, NV, 2011 – 2012. Project Manager - Led a team that updated the Clark County MJLHMP. Included innovative data analysis and GIS products. Managed a complex group of stakeholders from four incorporated cities (including Las Vegas) and two special districts.

Ventura County Multi-Jurisdiction Local Hazard Mitigation Plan, Ventura County, CA, 2010 – 2011. Project Manager - As project manager supported development of an award-winning plan. The 2010 LHMP was recognized as the Best Emergency Preparedness Plan by the Ventura County Emergency Coordinators Council.

2006 – 2008: FEMA RIX, Disaster Response Operations, Federal Coordinating Officer:

Federal Coordinating Officer, Director, Joint Field Office, Kiholo Bay Earthquake, Honolulu, HI: Led teams providing federal support to the State of Hawaii after the 2006 earthquake. Directed federal disaster relief programs from October 2006 to January 2007. Coordinated operations across agency and jurisdictional roles to achieve unity of action.

1976 – 2006: Captain, U.S. Navy:

US Navy, Deputy Chief of Staff, Plans and Exercises Division, US Coast Guard Pacific Area, 2004 - 2006:

Directed a joint team of twenty US Coast Guard and US Navy personnel in development of key operational and policy guidance for conduct of maritime operations in support of the Global War on Terrorism for the Pacific region. Served as the key point of contact to DOD for Coast Guard development of joint plans. Supported numerous national and regional level homeland security full scale exercises that included state, local and federal agency participation.

PROFESSIONAL CERTIFICATIONS | EDUCATION | TRAINING

- Certified Emergency Manager, International Association of Emergency Managers 2021
- Northwestern University, Master of Engineering Management



FRANCISCO SOTO, M.S EMERGENCY SERVICES – SENIOR PLANNER

PROFESSIONAL SUMMARY

Francisco Soto is the Director of Tandem Solutions. Mr. Soto has over 10 years of experience in emergency management, public safety, and project management in public, private, and special district organizations. He has served as a project manager/Principal writer for various emergency planning, training, and exercise projects. Mr. Soto has led the development writing for LHMP's for Hermosa Beach, Manhattan Beach, Palos Verdes Estates, Long Beach, and the Municipal Water District of Orange County. Mr. Soto has served as an EOC Director, EOC Coordinator, and Utilities Liaison for City and County-wide disasters. He thoroughly understands EOC organization, emergency/crisis response operations, and exercise conduct. Most importantly, Mr. Soto excels in stakeholder engagement and has experience collaborating with Police, Fire, Public Works, Health Department, City Management, and Public Information staff to develop effective emergency planning documents.

EXPERTISE:

- Hazard mitigation plan development and updates
- Hazard analysis and risk assessments
- Emergency Management Planning
- Communications
- Community outreach and engagement
- Stakeholder engagement
- Emergency Response

Relevant Experience:

City of Hermosa beach, Local Hazard Mitigation Plan Development, Project Manager/Lead Planner: Conducted Planning meetings with key stakeholders, led plan development, and conducted the public outreach campaign.

City of Manhattan Beach, Local Hazard Mitigation Plan Development, Project Manager/Lead Planner: Conducted Planning meetings with key stakeholders, led plan development, and conducted the public outreach campaign.

City of Rancho Palos Verdes Estates, Local Hazard Mitigation Plan Development, Project Manager/Lead Planner: Conducted planning meetings with key stakeholders, led plan development, and conducted the public outreach campaign.

Santa Clara Valley Water District, Dam Event Action Plan Development (2023), Planner: Supported the development of (10) ten Dam Event Acton Plans. Conducted stakeholder engagement, incorporated feedback, and coordinated the submission to the California Office of Emergency Services.

San Jose Water Company, Dam Event Action Plan Development (2023), Planner: Supported the development of 4 Dam Event Acton Plans. Conducted stakeholder engagement, incorporated feedback, and coordinated the submission to the California Office of Emergency Services.

Castro Valley Sanitary District, EOP Development and EOC SOP (2023), Planner: Supported the development of the District's EOP and EOC SOP. Conducted stakeholder engagement, led planning meetings, and incorporated feedback.

Inyo County, Emergency Operations Plan (EOP) (2023), Planner: Assisted in the update to the 2016 Inyo County EOP. The new EOP contains multiple incident specific and functional annexes. It was drafted to meet the latest legislative mandates regarding evacuation and equity. It addresses climate change impacts that affect county communities. The plan is pending review by Cal OES. The draft plan was validated at a County-wide tabletop exercise.

Los Angeles County Department Medical Examiner - Coroner, Mass Fatality Plan and Plan Workshop (2019), Project Manager/Lead Planner: Led writing, conducted informational interviews, outreach to stakeholders, led planning meetings, and conducted a training on the plan for regional stakeholders.

City of Manhattan Beach, EOP Update (2017), Project Manager/Planner: Updated the City EOP and multiple functional and incident specific annexes. Conducted stakeholder engagement, led planning meetings, and incorporated feedback.

Municipal Water District of Orange County, EOP Development and EOC Checklist (2018), Project Manager/ Lead Planner: Led the development/update of the Emergency Operations Plan (EOP). The update included a streamlined approach, update to current information, and the incorporation of corrective actions from previous training and exercises.

PROFESSIONAL CERTIFICATIONS | EDUCATION | TRAINING

California State University of Long Beach, Master of Emergency Services
California State University of Dominguez Hills, Bachelor of Criminal Justice

AARON COLE, MA GISP – GIS PLANNER

PROFESSIONAL SUMMARY

Mr. Cole (GISP): Has supported complex data management and geospatial analysis projects for over 15 years. His skills include Python application development, web application development, GIS and remote sensing analysis, cartographic design, small-scale to enterprise-level database design and administration.

Relevant Experience:

Focalpoint Geospatial, Co-Founder

- GIS capacity building and program development, geospatial analytical/pipeline development, Python tool development, web application development, advanced GIS and remote sensing analysis, cartographic design, enterprise database design and administration

Senior GIS Programmer Analyst, *Center for Integrated Spatial Research, UCSC*

- Develop, execute, and manage complex geospatial solutions across a broad range of industries and academic disciplines.
- Assist with coordination of center operations including developing and identifying new projects/funding pathways, interfacing with contractual representatives and stakeholders, and eliciting project requirements.
- Serve as GIS subject matter expert for transportation, planning, business, and public safety departments.

Lead GIS Analyst/Developer, InspecTools*

- Led in the development of GIS solutions for the wind, solar, and electric utility markets
- Served as GIS subject matter expert and technical advisor, providing recommendations, evaluations, and technical guidance to drive product development.
- Successfully managed multiple concurrent projects and coordinated efforts of contractors and staff.

GIS Analyst @ Santa Clara County Fire Department*

- Performed GIS infrastructure and software assessment and made recommendations to improve GIS practices in the department, including incident reporting, hydrant inspections, and integration with county databases.
- Redesigned and automated the production of over 700 print maps using Python, data

EXPERTISE:

- Over 15 years of GIS experience
- Certified Geographic Information Systems Professional
- Experience using ESRI ArcGIS software products
- Experience scripting in Python
- Excellent communication and analytical skills
- Expertise performing geospatial data building, modeling and analysis

driven pages, Adobe Illustrator, and InDesign

- Integrated and summarized incident report data into animated presentations for department leadership
- Configured ArcPad and trained department staff on use of Trimble handheld GPS devices and ArcPad software.

GIS Technician @ County of Nevada, California

- Interfaced with representatives from the Elections, Planning, Public Works, Sheriff's, and Assessor's Departments to elicit project requirements and develop GIS solutions
- Developed a series of Python scripts and improved editing workflow to increase the efficiency loading Assessor's CAD plats into ESRI's parcel fabric framework by a factor of 10.
- Used SQL Server Management Studio, Windows Task Scheduler, and Python script tools to automate ArcSDE database updates and integrate GIS with other county business systems.

GIS Analyst @ Center for Integrated Spatial Research, UC Santa Cruz

- Assisted in the planning, development, implementation, and management of GIS solutions.
- Performed advanced spatial analyses using ArcGIS and developed automated geoprocessing routines and workflows using Python.
- Developed funding opportunities and managed multiple concurrent projects and deadlines in a fast-paced environment.

PROFESSIONAL CERTIFICATIONS | EDUCATION | TRAINING

Geographic Information Systems Professional (GISP), Cert. No. 90198

California State University of San Jose, Master of Arts, Geography

University of California, Santa Cruz, Bachelor of Arts Business Management Economics



MEMO

DATE: April 4, 2024
TO: Board of Directors, San Lorenzo Valley Water District
FROM: Brian Frus, Interim General Manager
SUBJECT: Mid-Year Fiscal Report

WRITTEN BY: Heather Ippoliti, Consultant (RGS)
PRESENTED BY: Heather Ippoliti, Consultant (RGS)

STAFF RECOMMENDATION

It is recommended that the Board of Directors receive the Mid-Year Fiscal Report.

RECOMMENDED MOTION

No motion required - for information only.

BACKGROUND

Long term financial health requires regular reviews, setting sound fiscal policy, and understanding the financial impacts of budgetary decisions.

From a financial standpoint, governments differ from for-profit businesses in several different ways: legal structure, political process, and the lack of profit motive. Where the resources of profit businesses are driven by the free market, government activities are driven by budgets.

A budget is a financial plan projecting revenues and expenditures for a defined period. In the District's case, on June 21, 2023, the Board adopted a biennial budget covering the two-year period ending June 30, 2025. A biennial budget is two one-year budgets. The adopted budget includes budgets for each fund - water and sewer, as well as a capital budget tied to

the 5-year capital improvement plan.

DISCUSSION/ANALYSIS

This financial report summarizes the results for fiscal year 2023-24 as of December 31, 2023.

Summary. For fiscal year 2023-24 as of December 31, 2023, a statement of revenue and expenses is attached as Attachment 1. With 50% of the fiscal year elapsed, the revenues are at 52% of estimates and non-capital expenditures are at 49% of budget.

Revenue. With a few exceptions, the District's revenues are performing as projected. The District has received 52% of the estimated revenue, 4% more than last fiscal year for the same period. Except for four-line items, the District has received between 48% and 51% of the budgeted revenue estimates. The four-line items are Sales of Meters, Operating Grant Contributions, Interest Earned, and the contra-revenue account related to the Rate Assistance Program.

- **Sales of Meters.** As of December 31, 2023, the District has received no revenue from the sale of meters. There was no revenue received last fiscal year during the corresponding period. The fiscal year budget for this revenue is \$60,000.
- **Operating Grants.** As of December 31, 2023, the District has received no revenue from Operating Grants. Most grants received are related to capital projects. Last fiscal year the district received an operating grant of \$200,000 for vegetation management. The fiscal year budget is \$5,000.
- **Interest Earned.** During the six-month period ending December 31, 2023, the District earned \$384,846 in interest revenue: 4% more than the annual

budget, and 125% more than the same period of the prior year. In March 2023, staff transferred the unspent debt proceeds to T-bills that were expected to yield between 4.5 and 5%.

- **Contra-revenue Account Related to the Rate Assistance Program.** The Rate Assistance program provides an opportunity for a limited number of low-income customers to apply for financial assistance on their water bills. The program is funded with property tax revenue. As of January 8, 2024, there were 84 customers receiving a \$15 per month discount on their monthly bill. On January 18, 2024, the Board approved increasing the monthly discount to \$20 per month. The adopted budgets for the program are \$20,000 and \$25,000 for fiscal years 2023-24 and 2024-25. The year-to-date expense recorded through December 31, 2023, is \$7,260, down 9% from the same period of the prior year.

Expenditures. As of December 31, 2023, the District has spent 49% of the non-capital budget, 9% more than last fiscal year. There is only one department and one expense category with a variance of more than 5% above the expected expenditure rate of 50%: Administration (63%), and General & Administrative (77%). Department expenses are shown in Attachment 2.

- **General & Administrative.** As of December 31, 2023, 77% of the budget has been exhausted, 10% more than the same period last fiscal year. The largest expense in this category is property insurance. The property insurance is paid one time of year in July. Last year, the amount paid was \$233,708; this year the amount paid was \$259,667.
- **Administrative.** As of December 31, 2023, 63% of the budget has been exhausted, 33% more than the same period last fiscal year. However, this

is attributable to the rate study which was the largest contacted service this year to date. This year through December, \$190,496 was spent on Contract/Professional Services where last year only \$72,037 was spent. Property insurance is included in the administrative department. The other expense significant in this category is Contract/ Professional Services.

Capital Improvement Program. The Capital Improvement Plan (“CIP”) enables the District to plan, schedule, and finance capital projects to ensure cost effectiveness and conformance with established plans and policies.

The District’s CIP includes all infrastructure projects over a five-year period. The first two years of the five-year CIP are funded in the biennial budget and scheduled for completion. The last three years serve as the framework for future financial plans. The plan represents a phased approach to funding the projects needed to maintain the District’s infrastructure over the entire five-year period.

The FY 23-24 budget includes \$27,126,862 in planned capital improvements funded with debt proceeds, the fire surcharge, grants, and reserves. A listing of the District’s current year Capital Improvement Project expenses and their funding sources as of January 31, 2024, is attached as Attachment 3.

Fire Surcharge. On August 5, 2021, the Board adopted a resolution approving a fire surcharge. The surcharge will cease once \$5 million in revenue is collected. As of January 31, 2024, the District has collected \$2,432,327 in fire surcharge revenue.

There are capital improvement projects related to CZU fire that are currently funded with debt proceeds. Once the debt proceeds are exhausted, it is anticipated that the surcharge funds will be utilized. Attachment 4 shows the fire surcharge revenue and expense history.

Unspent Debt Proceeds. Attachment 5 shows the use of the debt proceeds since inception by fiscal year. As of January 31, 2024, fiscal year to date, the District has used \$932,500 from the 2020 Revenue COPs, and \$6,538,188 from the 2021 Installment Loan.

PRIOR COMMITTEE ACTION

On March 13, 2024, the Budget and Finance Committee received the Mid-Year Fiscal Report.

FISCAL IMPACT

No direct fiscal impact related to the proposed action.

ENVIRONMENTAL IMPACT

Pursuant to Title 14, the California Code of Regulations, Section 15302(c) of the California Environmental Quality Act (“CEQA”) guidelines, the proposed action is an administrative activity of the District that will not result in direct or indirect physical changes to the environment.

ATTACHMENTS

1. Statements of Revenues and Expenses
2. Operating Expenses by Department
3. Capital Project Expenses - FY 23-24 as of January 31, 2024
4. Fire Surcharge - Revenue and Expense History
5. Unspent Bond Proceeds since Inception

Attachment 1

**SAN LORENZO VALLEY WATER DISTRICT
STATEMENTS OF REVENUES & EXPENSES
FOR THE SIX MONTH PERIODS ENDED DECEMBER 31, 2023 AND 2022**

	23-24 Budget	Period ended 12/31/2023 Actual	Period ended 12/31/2022 Actual	% of budget spent/ rcvd	% change from prior year
Revenue					
Operating Revenue					
Water Usage Fees	7,722,600.00	\$ 3,942,162	\$ 3,722,214	51%	6%
Basic Charge	3,552,000	1,764,470	1,772,893	50%	0%
Sewer Charges	173,021	86,507	86,510	50%	0%
Sale of Meters	60,000	-	-	0%	0%
Fire Recovery Surcharge	1,000,000	494,724	494,323	49%	0%
Operating Contribution - Grant	5,000	-	200,000	0%	-100%
Miscellaneous Fees & Charges	90,000	42,465	41,023	47%	4%
Non-Operating Revenue					
Property Taxes	1,007,340	514,445	489,866	51%	5%
Interest - Investments	370,682	384,846	170,946	104%	125%
Assessment Rev - Lompico	294,000	147,192	146,756	50%	0%
Assessment Rev - Oly Mutual	49,500	24,217	24,224	49%	0%
Mobile Services Lease Fees	37,200	17,728	14,923	48%	19%
Rental Income	20,766	10,414	10,383	50%	0%
Contra Rev - Rate Assistance Program	(20,000)	(7,260)	(7,980)	36%	-9%
	14,362,109	7,421,910	7,166,081	52%	4%
Expense					
Operating Expense					
Salaries & Benefits	6,410,003	2,938,602	2,774,453	46%	6%
Contract/ Professional Services	1,237,813	663,807	445,287	54%	49%
Operating Expenses	464,400	196,956	199,726	42%	-1%
Maintenance	239,600	132,830	101,147	55%	31%
Facilities	693,625	301,571	310,021	43%	-3%
General & Administration	515,210	397,097	359,705	77%	10%
Non-Operating Expenses					
Investment In SMGWA JPA	164,681	164,681	-	100%	0%
Debt - Principal	1,250,616	639,220	738,321	51%	-13%
Debt - Interest	933,189	447,002	491,630	48%	-9%
	11,909,137	5,881,766	5,420,290	49%	9%
Capital					
Grant/FEMA Funded	6,977,489	1,493,360	-	21%	0%
Capital Projects	(27,126,862)	(8,379,546)	(2,851,560)	31%	194%
	(20,149,373)	(6,886,186)	(2,851,560)	66%	141%
Change in Working Capital	\$ (17,696,401)	\$ (5,346,042)	\$ (1,105,769)		
Use of Bond Proceeds	(15,130,366)	(7,110,232)			
Use of Reserves	(2,566,035)	1,764,190			
	(17,696,401)	(5,346,042)			
Budget:	unrestricted	restricted			
Beginning Working Capital	\$ 7,890,741	\$ 19,273,194			
Change in Working Capital	(2,566,035)	(15,130,366)			
Est. Ending Working Capital	\$ 5,324,706	\$ 4,142,828			
December 31, 2023:	unrestricted	restricted			
Beginning Working Capital	\$ 7,890,741	\$ 19,273,194			
Change in Working Capital	1,764,190	(7,110,232)			
Ending Working Capital	\$ 9,654,931	\$ 12,162,962			

Attachment 2

**SAN LORENZO VALLEY WATER DISTRICT
 OPERATING EXPENSES BY DEPARTMENT
 FOR THE SIX MONTH PERIOD ENDED DECEMBER 31, 2023 AND 2022**

	23-24 Budget	Period ended 12/31/2023 Actual	Period ended 12/31/2022 Actual	% of budget spent	% change from prior year
Administration	\$ 1,553,581	\$ 980,231	\$ 736,585	63%	33%
Finance & Business Services	1,591,913	831,381	658,923	52%	26%
Engineering	636,850	145,848	210,962	23%	-31%
Operations & Distribution	2,558,100	1,321,060	1,247,379	52%	6%
Environmental	412,137	206,526	114,884	50%	80%
Supply & Treatment	2,689,950	1,117,803	1,143,579	42%	-2%
Sewer Fund	118,121	28,014	78,026	24%	-64%
	\$ 9,560,651	\$ 4,630,863	\$ 4,190,339	48%	11%

Attachment 3

**SAN LORENZO VALLEY WATER DISTRICT
CAPITAL PROJECT EXPENSES
FOR THE SEVEN MONTH PERIOD ENDED JANUARY 31, 2024**

PROJECT	FY 23-24 Budget	FY 23-24 Expense thru 1/31/24	\$14.5M COP DEBT	\$15M COBANK LOAN	FIRE SURCHARGE 23-24	Grants & Reserves	Total	funding source
IRWIN BOOSTER - VALVE REBUILDS	\$ -	\$ 24,139				\$ 24,139	\$ 24,139	reserves
WO 1234 - LYON PIPELINE PROJECT	4,005,000	577,906	577,906				577,906	loan - 14.5
WO 1519 - NEW METER SETS	-	8,558				8,558	8,558	reserves
WO 1738 - FALL CREEK FISH LADDER	2,300,000	1,678,689	255,034			1,423,655	1,678,689	loan - 14.5/grant
WO 1919 - CZU_BENNETT SPRING RAW WATER LINE	150,000	499		499			499	loan - 15
WO 1920 - CZU_SOUTH RESERVOIR DISTRIBUTION SYSTEM	-	67		67			67	loan - 15
WO 1921 - CZU_ALTA VIA RD 4" HDPE MAIN	2,100,000	1,019,949		1,019,949	-		1,019,949	loan - 15
WO 1923 - CZU_ECKLEY TANK ZONE	25,000	1,623		1,623			1,623	loan - 15
WO 1924 - CZU_BIG STEEL TANK PIPING	1,250,000	802,729		802,729			802,729	loan - 15
WO 1927 - CZU_FOREMAN CREEK INTAKE/RAW WATER	1,300,000	19,177			19,177		19,177	czu
WO 1953 - CZU_HARMON STREET 2"	580,000	2,263		2,263			2,263	loan - 15
WO 1960 - CZU_PEAVINE INTAKE & PIPELINE	750,000	1,270		1,270			1,270	loan - 15
WO 1964 - CZU_SERVICE METER REPLACEMENT - FY 23-24 only	20,000	17,977			17,977		17,977	czu
WO 2077 - CZU_5 MILE BOX & TURBIDITY STATION	150,000	2,561		2,561			2,561	loan - 15
WO 2180 - BLUE RIDGE TANK REPLACEMENT	976,516	480,105		480,105			480,105	loan - 15/grant
WO 2181 - ORMAN ROAD WATER MAIN REPLACEMENT	1,051,932	629,244		629,244			629,244	loan - 15
WO 2182 - HERMOSA OAK FERNWOOD WTR MAIN REPLACEMENT	568,377	802,712		802,712			802,712	loan - 15
WO 2183 - JUANITA WOODS WATER MAIN REPLACEMENT	721,000	1,044,070		1,044,070			1,044,070	loan - 15
WO 2184 - ZAYANTE DRIVE WATER MAIN REPLACEMENT	899,037	635,960		635,960			635,960	loan - 15
WO 2436 - CA-9 BRIDGES MAIN REPLACEMENT Brookdale	350,000	557				557	557	reserves
WO 2516 - BIG BASIN CONSOLIDATION	-	431				431	431	reserves
WO 2517 - BRACKEN BRAE/FOREST SPRINGS CONSOLIDATION	1,800,000	53,071				53,071	53,071	grant
WO 272/549 - LYON WTR TREATM'T PLANT ACCESS RD SLIDE REPAIR	500,000	1,820				1,820	1,820	fema
WO 2909 - HUCKLEBERRY ISLAND 12IN RIVER CROSSING	750,000	486				486	486	fema
WO 2910 - BROOKSIDE MAIN BREAK - 2023 STORM	800,000	17,652				17,652	17,652	fema
WO 2911 - HWY 9 & PARK DR MAIN DAMAGE	-	87				87	87	fema
WO 2927 - MADRONE BOOSTER FLOODING	140,000	524				524	524	fema
WO 2944 - LYON ACCESS ROAD SLIDE	300,000	5,085				5,085	5,085	fema
WO 2946 - BEAR CREEK ESTATES BOOSTER	-	3,909				3,909	3,909	fema
WO 2948 - BULL CREEK RAW WATER SUPPLY	150,000	10,049				10,049	10,049	fema
WO 3016 - QUAIL HOLLOW RD STORM DAMAGE	1,000,000	737,397				737,397	737,397	fema
WO 3041 - NINA GENERATOR REPLACEMENT	-	877				877	877	fema
WO 3068 - BIG STEEL ZONE PIPING	1,345,000	1,115,137		1,115,137		-	1,115,137	loan - 15
WO 3077 - BEAR CREEK GENERATOR TRANSFER SWITCH	-	9,968				9,968	9,968	fema
WO 3192 - METER GRANT CHANGE OUT PROJECT (AMI)	200,000	68,223				68,223	68,223	grant
WO 411 - FELTON METER CHANGE OUT PROJECT	-	29,766				29,766	29,766	reserves
WO 525 - LOMPICO SERVICE LINE REPLACEMENT	-	8,205				8,205	8,205	reserves
WO 844 - LOST ACRES WATER TANK PROJECT (FELTON HEIGHTS)	100,000	4,803				4,803	4,803	reserves
WO 845 - REDWOOD PARK PIPELINE PROJECT	104,492	99,560	99,560				99,560	loan - 14.5

Attachment 3

**SAN LORENZO VALLEY WATER DISTRICT
CAPITAL PROJECT EXPENSES
FOR THE SEVEN MONTH PERIOD ENDED JANUARY 31, 2024**

PROJECT	FY 23-24 Budget	FY 23-24 Expense thru 1/31/24	\$14.5M COP DEBT	\$15M COBANK LOAN	FIRE SURCHARGE 23-24	Grants & Reserves	Total	funding source
WO 3384 - REDWOOD PARK TANK PROJECT	995,508	-					-	loan - 14.5/grant
WO 901 - GENERAL METER CHANGE OUTS		40,266				40,266	40,266	reserves
WO 3381 - BROOKDALE TANK COATING	300,000	-					-	reserves
WO 3380 - BLAIR TANK COATING	325,000	-					-	reserves
WO 3358 - FIRE HARDENING - PUMP STATIONS	600,000	-					-	reserves/grant
CAL TRANS HOLD	400,000	-					-	reserves
STUDIES	100,000	-					-	reserves
EQUIPMENT	20,000	-					-	reserves
	\$ 27,126,862	\$ 9,957,370	\$ 932,500	\$ 6,538,188	\$ 37,153	\$ 2,449,528	\$ 9,957,370	

Attachment 4

**SAN LORENZO VALLEY WATER DISTRICT
 FIRE SURCHARGE**

Income FY 21-22	\$ 904,312.91
Expenses FY 21-22	<u>(1,854,992.12)</u>
	(950,679.21)
Income FY 22-23	989,248.53
Expenses FY 22-23	<u>(75,525.26)</u>
	(36,955.94)
Income FY 23-24 thru 1/31/24	538,762.64
Expenses FY 23-24 thru 1/31/24	<u>(37,153.28)</u>
As of 1/31/24	<u>\$ 464,653.42</u>
Estimated revenue FY 23-24 to close	\$ 461,237.36
Estimated revenue FY 24-25	1,000,000.00
Estimated revenue FY 25-26	1,000,000.00
Estimated revenue FY 26-27	<u>106,438.56</u>
	<u>\$ 2,567,675.92</u>
Total revenue allowed	<u>\$ 5,000,000.00</u>

As allowed per Resolution #2 FY 21-22 adopted on 8/5/21

Attachment 5

**SAN LORENZO VALLEY WATER DISTRICT
 UNSPENT BOND PROCEEDS**

	2020 Revenue Certificates of Participation Bonds (2019 14.5m)	2021 Installment Purchase Agreement (CoBank 15.0m)
	\$ 14,912,354	\$ 15,000,000
issuance costs	(412,354.00)	(48,000.00)
construction 6/30/19	-	-
construction 6/30/20	(1,103,569.38)	-
construction 6/30/21	(3,554,861.02)	(1,670,838.09)
construction 6/30/22	(1,175,708.89)	(664,693.93)
construction 6/30/23	(2,953,455.44)	(2,300,616.69)
construction 6/30/24 thru 1/31	(932,500.00)	(6,538,188.00)
unspent as of 1/31/2024	\$ 4,779,905	\$ 3,777,663



**BOARD OF DIRECTORS
SAN LORENZO VALLEY WATER
DISTRICT
REGULAR MEETING
MINUTES
MARCH 21, 2024**

Thursday, March 21, 2024, at 5:30 p.m., SLVWD Conference Room, 12788 Highway 9, Boulder Creek, CA, and via videoconference and teleconference.

**1. Convene Meeting: 5:31 p.m.
Roll Call**

Board Members Present:

Jeff Hill, President
Bob Fultz, Director
Gail Mahood, Director
Mark Smolley, Director

Board Members Absent/Excused:

Jayne Ackemann, Vice President

Staff Present:

Barbara Brenner, District Counsel*
Holly Hossack, District Secretary
Scott Mattoch, Network Specialist

*Attended remotely

A motion was made and seconded to excuse Director Ackemann due to a prior commitment.

The motion passed unanimously.

- 2. Changes to Closed Session Agenda: None**
- 3. Oral Communications Regarding Items in Closed Session:**
B. Holloway, Boulder Creek, addressed the Board.
- 4. Adjournment to Closed Session: 5:35 p.m.**
- 5. Re-Convene Meeting: 6:30 p.m.
Roll Call**

Board Members Present:

Jeff Hill, President
Bob Fultz, Director

Gail Mahood, Director
Mark Smolley, Director

Board Members Absent/Excused:
Jayme Ackemann, Vice President

Staff Present:
Barbara Brenner, District Counsel*
Holly Hossack, District Secretary
Scott Mattoch, Network Specialist
Brian Frus, Interim General Manager
Garrett Roffe, District Engineer

6. **Report of Actions Taken in Closed Session:**
No reportable action was taken.
7. **Changes to the Agenda:**
Item 10c - WHOLESALE INTERTIE RATES was pulled from the agenda.
8. **Oral Communications:**
B. Holloway, Boulder Creek, addressed the Board.
9. **Unfinished Business:** None
10. **New Business:**
 - a. 2021 CIP PIPELINE REPLACEMENT PROJECT - CHANGE ORDERS
G. Roffe introduced and explained this item to the Board.

Discussion by the Board regarding:

- Validation of existing infrastructure
- Project area
- Total amount of changes to costs \$800K/within the normal range for change orders
- Specific change orders
- Templates for contracts
- Retaining wall was shown on the survey but not accounted for in the design
- Change order rejection
- Mistakes are sometimes made, this is a clean-up process

A motion was made and seconded to direct the Interim General Manager to execute change orders for:

- 1) Contract Change Orders 9, 10, 11, 12, 13, 14, 15, and 16 for payment to JMB Construction Inc. for the 2021 CIP Pipeline project in the sum of \$178,223, increasing the not to exceed contract amount from \$4,964,920 to \$5,143,143; and

- 2) Amended and Restated Professional Services Agreement with 360PSM in the sum of \$16,974, increasing the not-to-exceed contract amount from \$22,660 to \$39,634; and
- 3) Amended and Restated Professional Services Agreement with Sandis Civil Engineers Surveyors Planners in the sum of \$35,027, increasing the not to exceed contract amount from \$286,080 to \$321,107; and
- 4) A Professional Services Agreement with MME in the not to exceed contract amount of \$25,312; and
- 5) Authorizes the Interim General Manager to execute extensions and/or non-substantive modifications to the above Agreements, as necessary.

The motion passed unanimously.

- b. LYON/BIG STEEL PROJECT - CHANGE ORDERS
G. Roffe introduced and explained this item.

Discussion by the Board regarding:

- Additional change orders in negotiation for \$100K
- Additional 1" water service line - historical
- Purchasing in advance for better pricing

B. Holloway addressed the Board.

A motion was made and seconded that the Board direct the Interim General Manager to execute Contract Change Orders 1, 2, 4, and 5 for payment to Monterey Peninsula Engineering for the Lyon and Big Steel Zone Pipeline Improvements project in the sum of \$70,334, increasing the not-to-exceed contract amount from \$6,233,100 to \$6,303,434.

The motion passed unanimously.

- c. WHOLESALE INTERTIE RATES - Pulled from the agenda

11. **Consent Agenda:**

- a. CONFLICT OF INTEREST POLICY
- b. BOARD MEETING MINUTES 3.7.24

A motion was made and seconded to approve the Consent Agenda.

The motion passed unanimously.

12. **District Reports:** None

13. **Written Communication:** None

14. **Informational Material:**

- o SMGWA 2023 Independent Auditors' Report - noted

15. **Adjournment:** 7:05 p.m.

MEMO

DATE: April 4, 2024
TO: Board of Directors, San Lorenzo Valley Water District
FROM: Brian Frus, Interim General Manager
SUBJECT: Engineering Department Status Report - 1st Quarter 2024

WRITTEN BY: Garrett Roffe, Engineering Manager

PRESENTED BY: Garrett Roffe, Engineering Manager

STAFF RECOMMENDATION

It is recommended that the Board of Directors accepts the Engineering Department Status Report for the 1st Quarter 2024.

DISTRICT PROJECTS IN CONSTRUCTION

Glen Arbor Bridge Pipeline Replacement: Monterey Peninsula Engineering has submitted final payment applications. Staff are preparing documents for Board approval of change orders for final payments.

Alta Via Drive and Monan Way Pipelines: All water services are connected to the new water main. Contractor has started the additional work to relocate the District's water main to the southbound lane of Highway 9 for the Caltrans Viaduct Project. Paving is expected to be completed in May.

2021 CIP Pipeline Replacement Project: Blue Ridge Tank is in service. Contractor has started work on the site retaining wall. Paving for the Juanita Woods site, Hermosa Avenue site and Zayante Drive site are scheduled for May. The Orman Road site is complete pending any punchlist items resulting from final walk with Engineer of Record.

Fall Creek Fish Ladder: Contractor has completed the site erosion control work. Motor Control Center (MCC) factory testing is in progress. Installation of the MCC at the site is scheduled for early April to complete project pending final site walk for punchlists items with Engineer of Record.

Lyon and Big Steel Zone Pipeline Improvements: Contractor has completed the installation of the new water mains and will connect to the existing system following successful pressure tests, disinfection, and bacteriological testing. Paving is expected to be completed by end of April or early May.

Foreman Pipeline Access Trail Rehabilitation: Consultant McGuire and Hester has provided price for revised construction scope which is being reviewed by staff.

DISTRICT PROJECTS IN DESIGN

Consolidation of Bracken Brae and Forest Springs Mutuals: District is working on pre-consolidation agreements with both mutuals to construct a portion of the Phase 1 plans prepared by Sandis proportional to the remaining funding available for construction. Sandis has already removed the water storage tank reservoirs and associated improvements at the proposed tank site reducing initial project costs by over two million dollars. The District is considering two options for construction of the proposed pipeline with the remaining funding. Sandis has provided an engineer's estimate of probable construction costs for the two options and is awaiting direction on revising the plans. Once we have construction documents showing the work for which the project has funding, the District will publish the construction documents for competitive bidding. Currently, the term of the funding agreement requires construction work to be completed by December 31, 2024. The District is working with the California Department of Water Resources to extend the term beyond the current deadline.

2021 FEMA Project - Harmon Street: Staff reviewing bid set plans and specifications from Sandis.

Caltrans Highway 9 PM 12.12 Gabion Wall Emergency Repair: Staff have prepared plans for contractor pricing.

Department of Water Resources Urban Community Drought Relief Tank Replacement Project: District has drafted a Request for Proposals (RFP) for the design of Redwood Park Tank, Echo Tank, Highland Tank, Felton Heights (Lost Acre) Tank, South Tank and two pump stations. District has authorized an update to the geotechnical investigation report to include the proposed Lost Acre Drive site. After the proposed Lost Acre Drive site is determined buildable from a geotechnical perspective, District will work with the property owner towards acquisition of necessary property and/or easements.

Peavine Raw Water Pipeline: District has scheduled kickoff meeting with environmental consultant Panorama for April 8th. Following environmental approvals, District will contract with California Conservation Corps for the mitigation of hazardous trees and re-establishing the cross-country trail at 1% grade. Following the mitigation of hazardous trees, District will contract for survey mapping of the cross-country trail for use in development of the engineering plans. The engineering design concept is to follow the alignment and profile of the previous pipeline, looking for opportunities to harden the new pipeline from potential risk.

2023 Tank Rehabilitations: Work is on hold, Staff considering design build contract for repairs to Brookdale and Blair Tanks.

2021 FEMA Project - Eckley Zone: Work is on hold until Bracken Brae and Forest Springs Consolidation project is authorized.

Lyon Slide/Complex Access Road: Work is on hold, Sandis has provided concept plans for a new road alignment. Haro, Kasunich and Associates

has provided a proposal for additional geotechnical work for the new alignment.

CA-9 Bridges 05-1H470: Work is on hold until Caltrans provides updated schedule for the bridge replacements.

Huckleberry Island Main: District staff is coordinating with homeowners to execute the easements required for the proposed repairs.

Foreman Pressure Break: Design awarded to Freyer and Laureta. District attended the basis of design meeting at the end of January. Freyer and Laureta design concept of A-B filter system needs approval by FEMA but provides several benefits. Improved treatment plant operations, reduced cost, reduced footprint, reduced environmental impact in a sensitive area, and improved defensible space from any future fires.

Valley Gardens Housing Development: Staff are preparing the will serve letter documents for presentation to the Engineering and Environmental Committee.

Redwood Park Pipeline Project: District has recorded the Notice of Completion with the County Recorder. District will release retention payment to Contractor on April 10th.

GIS System Updates: Staff continues to work on mapping the existing system and the improvements to the system as construction projects proceed. Staff is currently mapping the location of the District meters and has completed approximately 4,800 meter locations.

Brookside Drive (Felton) Pipeline Project: District has received the completed topographic mapping. Staff preparing engineering plans for competitive bidding of the pipeline construction as soon as possible.

DISTRICT PROJECTS AWAITING DESIGN

Stewart Street Pipeline Project: No updates on this project

Five Mile Raw Water Pipeline: Design and construction to commence after Peavine Raw Water Pipeline project.

Bennett Spring Raw Water Pipeline: No updates on this project

Bull Creek Raw Water Pipeline: No updates on this project

DATE: April 4, 2024
TO: Board of Directors, San Lorenzo Valley Water District
FROM: Brian Frus, Interim General Manager
SUBJECT: Environmental Status Report - 1st Quarter, 2024

WRITTEN BY: Carly Blanchard and Chris Klier
PRESENTED BY: Carly Blanchard, Environmental Programs Manager

STAFF RECOMMENDATION

It is recommended that the Board of Directors accepts the Environmental Department status report for the 1st Quarter 2024.

GRANTS (ONGOING)

INFRASTRUCTURE GRANTS

Department of Water Resources - Urban Community Drought Relief Grant

- Awarded \$4.5 million to construct 6 fire/drought-hardened water tanks.
 - Grant agreement executed.
 - Request for proposals for tank design in draft.

Bureau of Reclamation WaterSMART Small-scale Efficiency Grant Program (Awarded \$100,000 for 522 meter replacements in Scotts Valley)

- 80% of meters installed.
- Quarterly report for Q1 in draft.

Santa Cruz Integrated Regional Water Management (IRWM)

- Awarded \$305K for 9 pumphouse structure hardening projects.
 - Evaluations of all sites are in process.

- CEQA noticing planned for May 2024

CalOES Hazard Mitigation Grant Program (HMGP)

- District awarded funding to complete a Local Hazard Mitigation Plan to qualify the District for future HMGP funding opportunities.
 - Agreement pending BoD approval, 4/4/2024.

CAL FIRE - Forest Health Grant

- Fuel reduction around critical water infrastructure, planting, and invasive removal at Olympia Watershed property.
 - Environmental and cultural surveys are in process.

Upcoming grants:

State Revolving Funding (SRF) - Forest Springs

- Application submitted.

Please see the attached grant tracking table at the end of the report or click [HERE](#) for further information on District grant applications and awards.

ENVIRONMENTAL COMPLIANCE - CAPITAL IMPROVEMENT PROGRAM (ONGOING)

CONJUNCTIVE USE

- Regulatory agency permitting (including diversion permitting) is in progress.
- Loch Lomond Feasibility Request for Proposals (RFP) updated for re-release.

CIP PROJECT PERMITTING

Staff is working to secure permits for the following projects:

Current Projects

1. CIP Project Permitting

- a) Lyon Treatment Plant Access Road Slide (FEMA funded - 2023)
 - The route is being determined.
- b) Peavine pipeline
 - California Conservation Corps agreement pending BoD approval, 4/4/24.
 - Environmental permitting and analysis kicked off on March 20, 2024.
- c) Huckleberry Island pipeline replacement
 - Bridge crossing assessment for easement value in process.
 - Environmental analysis will follow once easements are completed.
- d) Fuel Reduction Annual Maintenance Contract
 - Fuel reduction contract expended March 2024.
 - Grants to fund additional work.
- e) Felton Heights Tank
 - Awaiting Geotech and easement
- f) Fall Creek Fish Ladder
 - Revegetation planned for April 2024
 - Interpretive sign is being printed
- g) Valley Gardens will serve letter
 - Staff to bring the recommendation to the Environmental/Engineering Committee

2. FEMA

- a) APTIM consulting working to move FEMA projects ahead with staff

WATERSHED MANAGEMENT/ STEWARDSHIP

SOLAR PANELS

Staff working to complete solar panel cleaning contract with Good Clean Sun. Kick-off is planned for April.

OLYMPIA PATROL (ONGOING)

Report received for Q1 2024, no trespassing reported.

WATERSHED TRESPASS (ONGOING)

None reported.

WATER CONSERVATION (ONGOING)

EXECUTIVE ORDER N-7-22

District in Water Shortage Stage 1.

RAIN UPDATE

Water year 23/24 (October 1, 2023 - September 30, 2024) rainfall totals in downtown Boulder Creek thus far are 36.26 inches. For current rainfall totals visit <https://www.slvwd.com/about-us/pages/local-weather-rainfall>

PUBLIC OUTREACH

Miller Maxfield provides outreach summaries quarterly. The 2024 Q1 report is attached at the end of this report.

NETWORKING and COLLABORATIONS

GREEN BUSSINESS PROGRAM

The District was certified as a Santa Cruz County Green Business in March 2024.

SANTA CRUZ NATURAL HISTORY MUSEUM EARTH STEWARDSHIP PROGRAM

The first event of the year took place in March 2024 at the Kirby Water Treatment plant, where Earth Stewards removed 175 pounds of invasives.

ASSOCIATION OF ENVIRONMENTAL PROFESSIONALS (AEP)

Staff planning to attend a networking event in April 2024.

UPCOMING EVENTS

State of the San Lorenzo River Symposium on Saturday, April 13, from 8:30 a.m. to 12:30 p.m. at Felton Community Hall.

Learn more: <https://sites.google.com/view/soslrs/home>

Attachments

- San Lorenzo Valley Water District Grant Funding Table
- Outreach 2024 Q1 Report

San Lorenzo Valley Water District

Quarterly Report: Jan 1, 2024 - March 21, 2024
Prepared by Miller Maxfield, Inc., March 22, 2024

Overview

Below is an update on the communications and outreach work that Miller Maxfield, Inc. (M2) has done on behalf of the San Lorenzo Valley Water District (SLVWD). That work included content creation for social media, managing social media platforms, sending regular email updates to customers, working closely with SLVWD to provide community updates on the annual flushing program, advertising for open positions, coordinating a community workshop to discuss the rate study/Proposition 218 process and more.

Facebook and Instagram: Total Engagements

Facebook and Instagram - Total Engagements Q1 2024

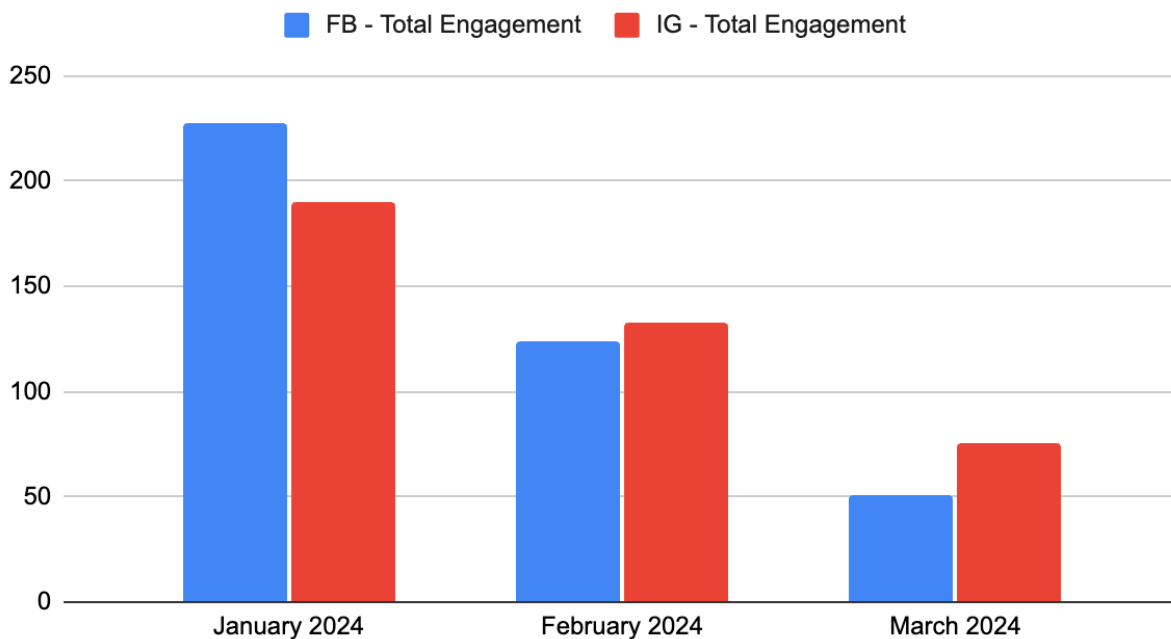

This chart shows the total engagement on Facebook and Instagram from Jan. 1, 2024, until March 21, 2024. This includes standard (unboosted) posts, as well as boosted social posts on both platforms that were done to promote District job openings and share meeting information. Total engagement refers to any action someone takes on SLVWD's

posts. The most common examples are reactions (including likes), comments and shares. Engagement also includes saves, viewing a video, or clicking on a link.

The spike in January numbers is a result of boosting a social media post to promote a January event for the District as well as an indication of higher engagement with posts. M2 is attributing the increased attention to the Prop 218 community meeting hosted by SLVWD on Jan. 20, 2024. March performance showed a return to normal levels of engagement as well as reporting statistics before the end of the month.

	Jan. 2024	Feb. 2024	March 2024
Total Posts	19	14	11
Engagement on Facebook Organic and Boosted Posts	228	124	51
Engagement on Instagram Organic and Boosted Posts	190	133	75

Facebook and Instagram: Total Reach

Facebook and Instagram - Total Reach Q1 2024

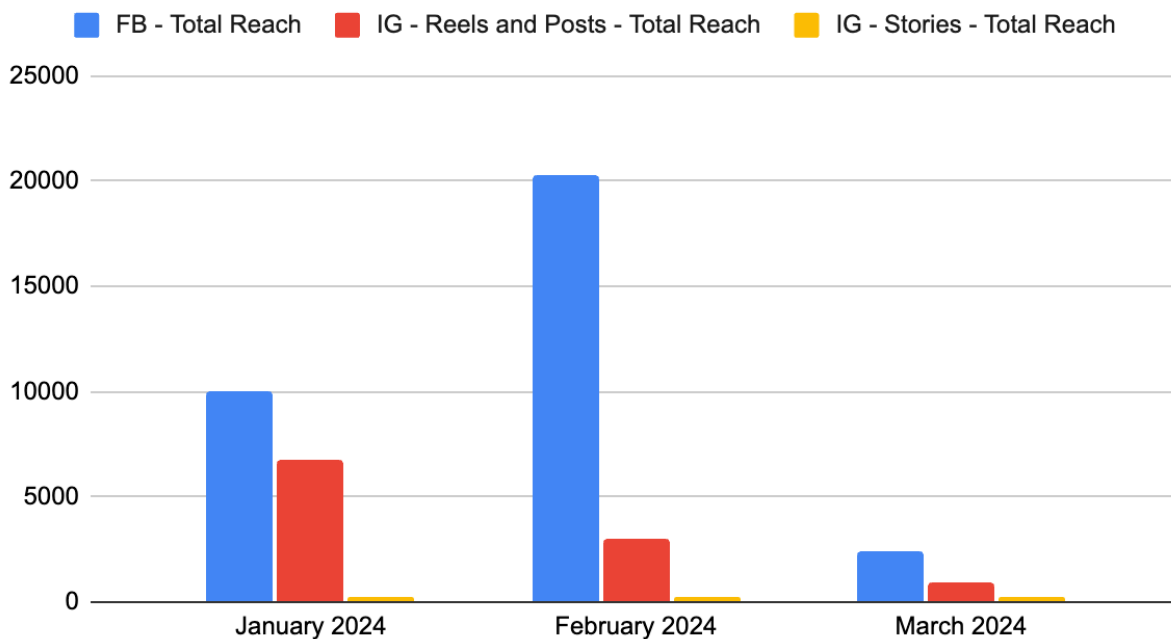

This chart shows the total reach on Facebook and Instagram from Jan. 1, 2024, until March 21, 2024. This includes boosted social posts on both platforms that were paid to promote job openings and community meetings with the District. Total reach includes the total number of people reached by posts.

The spike in February is attributed to boosted posts advertising the job opening for the Administrative Assistant/District Secretary position.

Facebook and Instagram Posts			
	Jan. 2024	Feb. 2024	March 2024
Total Posts	19	14	11
Reach of Facebook Organic and Boosted Posts	10,008	20,263	2,443
Reach of Instagram Organic and Boosted Posts	6,793	3,013	971

Here are metrics for Instagram stories to show the growth and engagement there. The statistic is key given the popularity of short-form videos across social media.

Instagram Stories			
	Jan. 2024	Feb. 2024	March 2024
Total Posts	3	4	5
Reach of Instagram Stories Organic and Boosted	255	234	225

Email Newsletter

Newsletter			
	Jan. 2024	Feb. 2024	March 2024
Open Rate %	49%	50.6%	46.8%
# of Opens	1,962	2,047	1,882

This table shows the newsletter open rate percentages from Jan. 1, 2024, until March 21, 2024. Open rates reflect when an SLVWD newsletter subscriber opens the newsletter.

The average open rate according to Mailchimp is less than 35%. SLVWD's newsletter open rates are above average, with an average open rate of 48.8% for the three-month period.

NextDoor

NextDoor is a hyperlocal platform that allows residents in a given region to discuss issues with one another. M2 supported SLVWD in monitoring the platform and responding promptly to various posts.

	Post	Replies	Impressions
NextDoor	3	1	5,086

Additional Communication and Strategy Support

Press Releases

M2 drafted and issued two press releases for SLVWD during the quarter. The press releases created consistent and clear messaging for high-profile topics. The press releases and articles that came as a direct result of this outreach are listed below.

- Feb. 16, 2024 - [San Lorenzo Valley Water District Board Approves Rate Increase in Response to Fire and Storm Recovery Costs](#)
 - Feb. 16, 2024 - [San Lorenzo Valley Water District approves increasing rates over 5 years - KSBW](#)

- Feb. 16, 2024 - [San Lorenzo Valley Water District approves water rate increase - KION](#)
-
- Feb. 22, 2024 - [Annual System Flushing Begins in March for San Lorenzo Valley Water District](#)
 - Feb. 27, 2024 - [San Lorenzo Valley Water District annual flushing to begin next month - Santa Cruz Sentinel](#)
 - March 21, 2024 - [Water main flushing occurs this spring in San Lorenzo Valley - Press Banner](#)

Prop 218

Following the December decision from the SLVWD Board of Directors to move forward with the Prop 218 process, M2 provided strategic communication support to create community engagement and share key information about the process. Support included content design and production of notices for the community meeting, social media content, media outreach and website content.

This support also included assisting SLVWD with organizing the Jan. 20 community meeting where more than 50 interested District customers attended.

Hiring Support: District Secretary/Administrative Assistant

In support of an immediate need to hire and train a new District Secretary/Administrative Assistant, M2 supported the efforts by creating an advertising plan for the position. That plan included outreach to local media platforms and social media advertising.

The District received many applicants for the position as a result.

Website

M2 provided regular updates to pages at the direction of SLVWD staff, including:

- Ongoing support/exploration to launch an online bill calculator tool
- Adding press releases to the website
- Updating content and uploading documents
- Editing and auditing project pages to create approachable language for customers
- Identifying opportunities to provide project updates for customers

MEMO

DATE: April 4, 2024
TO: Board of Directors, San Lorenzo Valley Water District
FROM: Brian Frus, Interim General Manager
SUBJECT: Finance & Business Services Status Report

WRITTEN BY: Heather Ippoliti, Consultant (RGS)
PRESENTED BY: Heather Ippoliti, Consultant (RGS)

STAFF RECOMMENDATION

It is recommended that the Board of Directors review and file the Finance & Business Services Department Status Report for year-to-date through January 31, 2024.

RECOMMENDED MOTION

None

BACKGROUND

CUSTOMER SERVICE SUPPORT

- Customer Service Dept Summary
- Monthly Consumption by Customer Class
- Weekly Call Log

REVENUE STABILIZATION RATE (“RSR”) ANALYSIS

This packet contains the current consumption as compared to the prior 3-year averages for the RSR. As of January 2024, the cumulative consumption

is 1% below the baseline and 4.5% lower than the prior year. We will continue to monitor consumption and update the Board, as necessary.

RATE ASSISTANCE PROGRAM

As of January 31, 2024, there are 84 approved applications.

PAST DUES

There was a 16% increase in the balance of accounts 30+ days past due and a 4% decrease in the number of accounts 30+ days past due between October 2023, and January 2024. As of January 31, there were 97 active liens with the County totaling \$37,713.

FINANCIAL SUMMARY

This package contains year-to-date financial information as of January 31, 2024. Some highlights include:

- Overall Operating Revenue: Year-to-date revenue as of January 31, increased by \$178,672 compared to the prior year. This was primarily due to an increase in consumption.
- Overall Operating Revenue excluding Fire Recovery Surcharge (“FRS”) was \$6.7M for the seven-month period ended January 31. Excluding the FRS, operating revenue had a 3% increase from last year.
- Operating Expenses: Year-to-date expenses as of January 31, were 14% higher than the prior year, primarily due to an increase in Salaries & Benefits, Insurance and Contract/Professional Services.

- Operating Income (loss): operating income for the seven-month period ending January 31, was \$1.6M.
- Operating Income, excluding FRS, was \$1.1M for the seven-month period ending January 31.
- Overall Outlook: In looking at the numbers for January, the numbers are in line with budgeted expectations.

	January		Full Year	
	Current Month	YTD	Budget	% of Budget
Operating Revenue (excluding Fire Recovery Surcharge)	\$ 845,554	\$ 6,681,158	\$ 11,597,621	57.6%
Less: Operating Expenses	751,400	5,615,492	9,860,651	56.9%
Operating Income (Excluding Fire Recovery Surcharge)	\$ 94,154	\$ 1,065,666	\$ 1,736,970	61.4%

CUSTOMER SERVICE DEPT SUMMARY

These statistics are meant to show some of the trends and fluctuations in utility billing related items. Management will use these to look for abnormalities or seasonal trends that can impact staff time. For example, the cut in/out process is typically correlated to the real estate market.

Monthly Stats:	Jan-24	Dec-23	Nov-23	Oct-23	Sep-23	Aug-23	Jul-23	Jun-23	May-23	Apr-23	Mar-23	Feb-23	Jan-23
Cut In/Outs	20	21	11	25	24	24	24	36	38	20	20	12	24
# Past Due Accounts	1,311	1,335	1,254	1,373	1,332	1,249	1,294	1,228	1,160	1,287	1,461	1,098	1,168
# Receiving IVR	984	1,010	934	1,026	1,000	934	956	968	874	965	998	800	861
# Late Penalties	827	819	397	446	819	765	762	794	782	832	830	821	930
Past Due Balances (30+ Days) [1]	\$ 441,187	\$ 446,702	\$ 382,051	\$ 380,490	\$ 338,891	\$ 308,548	\$ 350,800	\$ 462,599	\$ 434,086	\$ 451,752	\$ 448,724	\$ 463,193	\$ 418,494
Rate Assistance Program (RAP)													
Approved Applications	91	84	82	82	78	78	76	74	93	93	93	92	92
Pending Applications	0	0	1	1	0	0	0	0	0	0	0	0	0
Online / Going Green													
<i>As of 3/22/2023</i>													
Online Sign-ups	5,464	5,441	5,425	5,400	5,362	5,339	5,330	5,295	5,255	5,235	5,207	5,173	5,155
E-Bills	2,640	2,640	2,601	2,601	2,577	2,564	2,542	2,509	2,492	2,471	2,455	2,428	2,400
Auto Pay	3,789	3,787	3,775	3,775	3,768	3,756	3,734	3,712	3,687	3,654	3,625	3,589	3,580

13 MONTH CONSUMPTION TRENDS

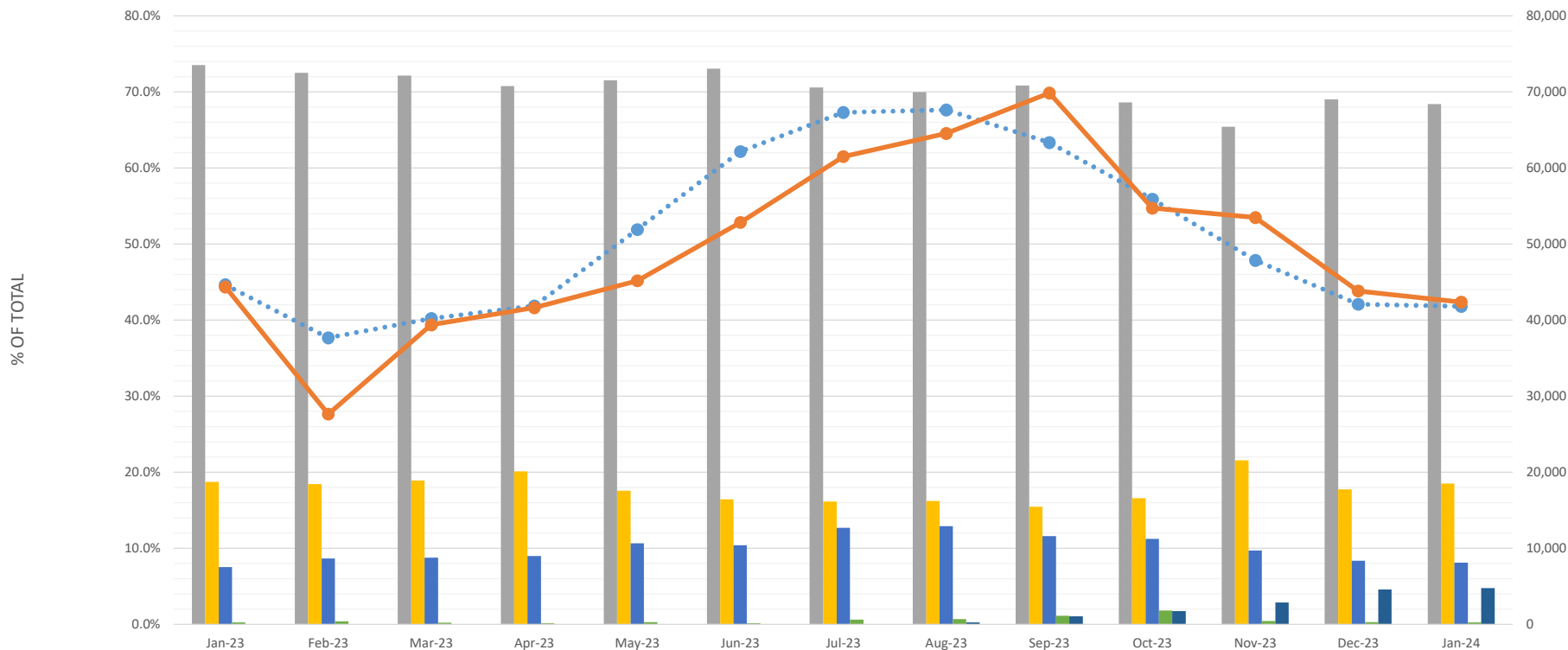

	Jan-23	Feb-23	Mar-23	Apr-23	May-23	Jun-23	Jul-23	Aug-23	Sep-23	Oct-23	Nov-23	Dec-23	Jan-24
Residential	73.5%	72.5%	72.1%	70.8%	71.5%	73.0%	70.6%	70.0%	70.8%	68.6%	65.4%	69.0%	68.4%
Multi Residential	18.7%	18.4%	18.9%	20.1%	17.5%	16.4%	16.1%	16.2%	15.4%	16.6%	21.6%	17.7%	18.5%
Commercial	7.5%	8.7%	8.8%	9.0%	10.7%	10.4%	12.7%	12.9%	11.6%	11.3%	9.7%	8.4%	8.1%
Bulk Water	0.3%	0.4%	0.2%	0.2%	0.3%	0.1%	0.6%	0.7%	1.1%	1.8%	0.4%	0.3%	0.3%
Other Systems	0.0%	0.0%	0.0%	0.0%	0.0%	0.0%	0.0%	0.2%	1.0%	1.7%	2.9%	4.6%	4.8%
BUDGETED UNITS	44,636	37,666	40,218	41,852	51,909	62,163	67,284	67,631	63,352	55,912	47,853	42,069	41,798
ACTUAL UNITS	44,352	27,637	39,375	41,619	45,177	52,842	61,500	64,544	69,858	54,709	53,476	43,838	42,350

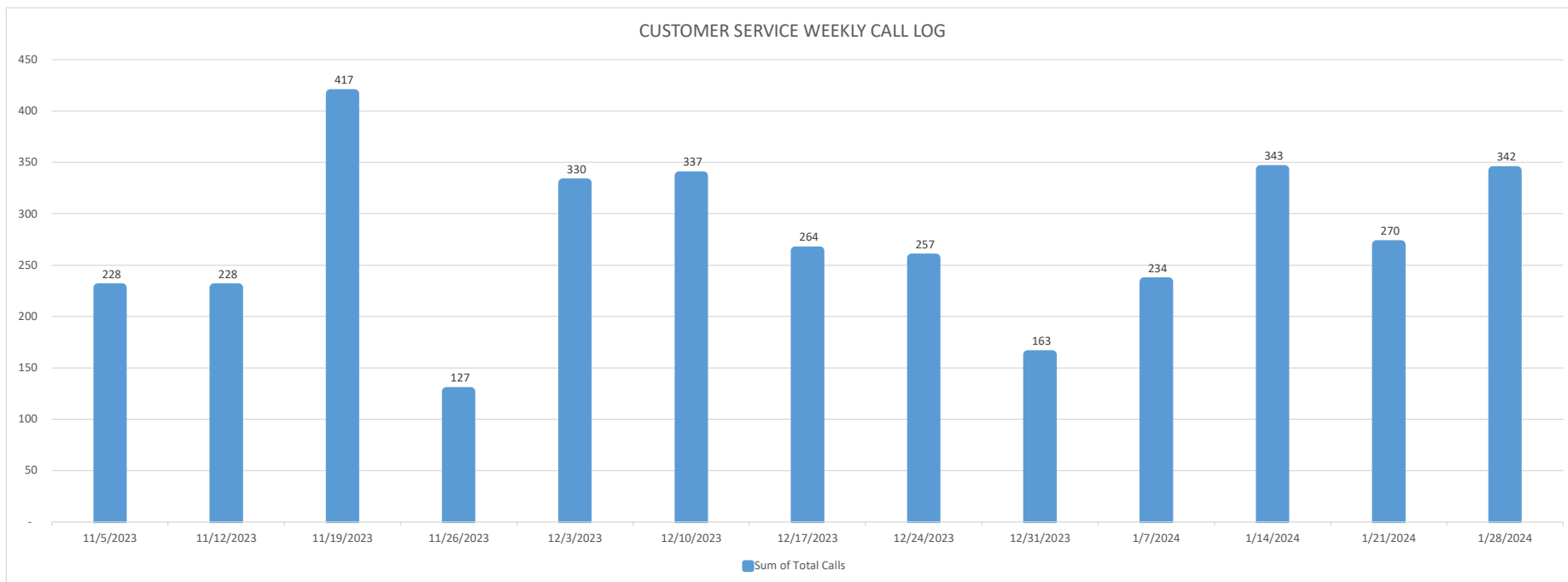

REVENUE STABILIZATION RATE ANALYSIS FY23-24

In accordance with the District's Revenue Stabilization Rates Policy & Procedures, the District Manager shall provide the Board of Directors with the average units of water sales (by month) for the rolling previous three years, which will serve as the baseline against which current annual sales to date will be compared. If the District Manager determines that budget-year water sales (in units) to date, and corresponding revenue, is more than 10% below expected year-to-date levels (based on monthly averages over the previous three years), the District Manager shall notify, at a public meeting, the Board of Directors of this determination at or before the next regularly scheduled Board meeting. For more information, please refer to the District's full Policy & Procedures.

MONTHLY CONSUMPTION IN UNITS BY FISCAL YEAR (BASELINE)

	July	August	September	October	November	December	January	TOTAL
FY2021	75,312	78,208	67,686	64,547	55,021	47,697	46,950	686,348
FY2122	67,878	69,234	55,672	56,472	44,129	39,798	39,208	616,405
FY2223	68,829	63,207	64,322	50,922	44,500	43,180	44,352	585,962
3 YR AVERAGE (BASELINE)	70,673	70,216	62,560	57,314	47,883	43,558	43,503	629,572

ACTUAL FY2324 CONSUMPTION

FY2324	61,500	64,544	69,858	54,709	53,476	43,838	42,350	390,275
--------	--------	--------	--------	--------	--------	--------	--------	----------------

CUMULATIVE ANALYSIS

% Above or Below Average	-13%	-8%	12%	-5%	12%	1%	-3%	
Cumulative %	-13%	-11%	-4%	-4%	-1%	-1%	-1%	

NOTES:

As of January 2024, the cumulative consumption is 1% below the baseline. Consumption for January is 3% below the 3 year average baseline and 5% lower than prior year. We will continue to monitor consumption and update the Board as necessary.

SAN LORENZO VALLEY WATER DISTRICT - PAST DUE ANALYSIS - JAN 24

CYCLE 1						
	Bal Fwd	Bal Under 30	Bal 30 to 60	Bal 60 to 90	Bal 90 to 120	Bal Over 120
Owner	\$ 220,446	\$ 65,012	\$ 31,905	\$ 19,799	\$ 17,133	\$ 86,598
<i># of accounts</i>		580	247	161	135	120
IVR/PAST DUE INFORMATION:						
PAST DUE PRIOR TO IVR	522					
# RECEIVING IVR	398	76%	% signed up for IVR			
FINAL PAST DUE	371	71%	% from initial past due			

CYCLE 2						
	Bal Fwd	Bal Under 30	Bal 30 to 60	Bal 60 to 90	Bal 90 to 120	Bal Over 120
Owner	\$ 374,756	\$ 89,003	\$ 40,779	\$ 51,706	\$ 21,871	\$ 171,397
<i># of accounts</i>		734	313	231	193	181
IVR/PAST DUE INFORMATION:						
PAST DUE PRIOR TO IVR	789					
# RECEIVING IVR	586	74%	% signed up for IVR			
FINAL PAST DUE	456	58%	% from initial past due			

TOTAL DISTRICT						
BILLS SENT IN JANUARY						
	Bal Fwd	Bal Under 30	Bal 30 to 60	Bal 60 to 90	Bal 90 to 120	Bal Over 120
Owner	\$ 595,202	\$ 154,015	\$ 72,684	\$ 71,505	\$ 39,004	\$ 257,995
<i># of accounts</i>		1,314	560	392	328	301
BALANCE OF ACCOUNTS						
30+ DAYS PAST DUE	441,187					
# OF ACCOUNTS 30+ DAYS PAST DUE	1,581					
IVR/PAST DUE INFORMATION:						
PAST DUE PRIOR TO IVR	1,311					
# RECEIVING IVR	984	75%	% signed up for IVR			
FINAL PAST DUE	827	63%	% from initial past due			
LT PAYMENT PLANS	10					
LIEN INFORMATION:						
# ACTIVE LIENS	97					
TOTAL BALANCE	\$ 34,713	13%	% collateralized of Owner Bal Over 120			

PRIOR MONTH DECEMBER COMPARISON						
	Bal Fwd	Bal Under 30	Bal 30 to 60	Bal 60 to 90	Bal 90 to 120	Bal Over 120
	\$ 231,519	\$ 81,185	\$ 29,363	\$ 25,197	\$ 19,233	\$ 76,542
<i># of accounts</i>		657	247	169	145	120

PRIOR MONTH DECEMBER COMPARISON						
	Bal Fwd	Bal Under 30	Bal 30 to 60	Bal 60 to 90	Bal 90 to 120	Bal Over 120
	\$ 396,378	\$ 100,010	\$ 82,498	\$ 27,893	\$ 24,987	\$ 160,990
<i># of accounts</i>		845	335	240	201	175

PRIOR MONTH DECEMBER COMPARISON						
	Bal Fwd	Bal Under 30	Bal 30 to 60	Bal 60 to 90	Bal 90 to 120	Bal Over 120
	\$ 627,897	\$ 181,195	\$ 111,861	\$ 53,089	\$ 44,220	\$ 237,531
<i># of accounts</i>		1,502	582	409	346	295
BALANCE OF ACCOUNTS						
30+ DAYS PAST DUE	446,702					
# OF ACCOUNTS 30+ DAYS PAST DUE	1,632					
	-1%					
% change from prior month for 30+ days past due						

* Lien amount may be larger than 120+ day bucket due to the fact it will include their entire balance.

OPERATING ANALYSIS - YTD FY2324 (JULY-JAN)

PRELIMINARY NUMBERS - SUBJECT TO CHANGE

REVENUE BY CATEGORY

DESCRIPTION	COMPARING AGAINST PRIOR YEAR					COMPARING AGAINST BUDGET		
	ACTUALS	% OF TOTAL	PRIOR YEAR	\$ Diff.	% Diff.	Act. % of Budget	ANNUAL BUDGET	% of Annual
WATER USAGE	\$ 4,468,395	61.6%	\$ 4,283,606	\$ 184,790	4%	58%	\$ 7,722,600	61%
BASIC CHARGES	2,061,092	28.4%	2,068,857	(7,764)	0%	58%	3,552,000	28%
FIRE RECOVERY SURCHARGE	577,485	8.0%	576,900	585	0%	58%	1,000,000	8%
METERS, PENALTIES & OTHER	50,745	0.7%	49,680	1,065	2%	34%	150,000	1%
SEWER CHARGES	100,925	1.4%	100,928	(3)	0%	58%	173,021	1%
TOTAL OPERATING REVENUE	\$ 7,258,643	100.0%	\$ 7,079,971	\$ 178,672	3%	58%	\$ 12,597,621	100%

REVENUE COMMENTS*

Water Usage: Outside Agency

**See detail below for Operating Revenue excluding the Fire Recovery Surcharge*

EXPENSES BY CATEGORY

DESCRIPTION	COMPARING AGAINST PRIOR YEAR					COMPARING AGAINST BUDGET		
	ACTUALS	% OF TOTAL	PRIOR YEAR	\$ Diff.	% Diff.	Act. % of Budget	ANNUAL BUDGET	% of Annual
SALARIES & BENEFITS	\$ 3,604,138	64.2%	\$ 3,257,100	\$ 347,038	11%	54%	\$ 6,710,003	68%
CONTRACT/PROF. SERVICES	760,792	13.5%	512,017	248,775	49%	61%	1,237,813	13%
OPERATING EXPENSES	276,768	4.9%	294,706	(17,937)	-6%	60%	464,400	5%
MAINTENANCE	157,683	2.8%	119,127	38,556	32%	66%	239,600	2%
FACILITIES	364,405	6.5%	361,608	2,798	1%	53%	693,625	7%
GEN. & ADMIN.	451,705	8.0%	375,835	75,870	20%	88%	515,210	5%
TOTAL OPERATING EXPENSES	\$ 5,615,492	100%	\$ 4,920,393	\$ 695,099	14%	57%	\$ 9,860,651	100%

EXPENSE COMMENTS

Salaries & Benefits: One time payout/COLA Retro/Staff Retirement

Contract/Prof. Services: Rate Study \$94,321, Legal \$64,714, Public Outreach \$61,662

Gen & Admin: Property Ins \$268,730

Maintenance: Johnson building \$26,610,

% BREAKDOWN OF CATEGORY EXPENDITURES

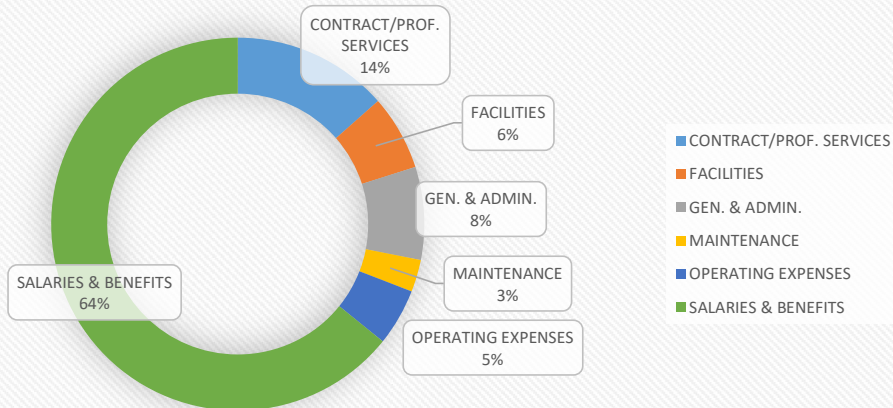

EXCLUDING FIRE RECOVERY SURCHARGE

REVENUE BY CATEGORY

DESCRIPTION	COMPARING AGAINST PRIOR YEAR					COMPARING AGAINST BUDGET		
	ACTUALS	% OF TOTAL	PRIOR YEAR	\$ Diff.	% Diff.	Act. % of Budget	ANNUAL BUDGET	% of Annual
WATER USAGE	\$ 4,468,395	66.9%	\$ 4,283,606	\$ 184,790	4%	58%	\$ 7,722,600	67%
BASIC CHARGES	2,061,092	30.8%	2,068,857	(7,764)	0%	58%	3,552,000	31%
FIRE RECOVERY SURCHARGE								
METERS, PENALTIES & OTHER	50,745	0.8%	49,680	1,065	2%	34%	150,000	1%
SEWER CHARGES	100,925	1.5%	100,928	(3)	0%	58%	173,021	1%
TOTAL OPERATING REVENUE	\$ 6,681,158	100.0%	\$ 6,503,071	\$ 178,088	3%	58%	\$ 11,597,621	100%

OPERATING ANALYSIS - YTD TREND FY23-24

PRELIMINARY NUMBERS - SUBJECT TO CHANGE

REVENUE BY CATEGORY

DESCRIPTION	JULY	AUGUST	SEPTEMBER	OCTOBER	NOVEMBER	DECEMBER	JANUARY	YTD	BUDGET	% OF BUD.
WATER USAGE	350,638	814,799	876,435	688,477	668,964	542,848	526,234	4,468,395	7,722,600	58%
BASIC CHARGES	295,887	297,093	296,134	296,470	296,082	282,804	296,622	2,061,092	3,552,000	58%
FIRE RECOVERY SURCHARGE	82,458	82,327	82,510	82,471	82,580	82,377	82,761	577,485	1,000,000	58%
METERS, PENALTIES & OTHER	8,790	8,110	8,590	4,335	4,380	8,260	8,280	50,745	150,000	34%
SEWER CHARGES	14,416	14,418	14,418	14,418	14,230	14,607	14,418	100,925	173,021	58%
TOTAL OPERATING REVENUE	752,189	1,216,748	1,278,087	1,086,171	1,066,236	930,897	928,315	7,258,643	12,597,621	58%

EXPENSES BY CATEGORY

DESCRIPTION	JULY	AUGUST	SEPTEMBER	OCTOBER	NOVEMBER	DECEMBER	JANUARY	YTD	BUDGET	% OF BUD.
SALARY & BENEFITS	881,441	451,848	410,527	451,199	612,286	350,954	445,883	3,604,138	6,710,003	54%
CONTRACT/PROF. SERVICES	58,069	36,434	87,571	167,523	159,983	151,542	99,670	760,792	1,237,813	61%
OPERATING EXPENSES	27,367	29,768	32,696	29,044	24,019	54,062	79,812	276,768	464,400	60%
MAINTENANCE	13,918	20,436	14,480	29,852	35,309	18,837	24,853	157,683	239,600	66%
FACILITIES	15,902	31,075	72,466	63,099	63,471	54,963	63,430	364,405	693,625	53%
GEN. & ADMIN.	302,931	33,762	20,933	22,411	9,025	24,892	37,751	451,705	515,210	88%
TOTAL OPERATING EXPENSES	1,299,627	603,321	638,673	763,129	904,092	655,250	751,400	5,615,492	9,860,651	57%
OPERATING INCOME (LOSS)	(547,438)	613,427	639,415	323,042	162,144	275,647	176,915	1,643,151	2,736,970	60%

OPERATING MARGIN	JULY	AUGUST	SEPTEMBER	OCTOBER	NOVEMBER	DECEMBER	JANUARY	YTD	BUDGET	
OPERATING REVENUE	752,189	1,216,748	1,278,087	1,086,171	1,066,236	930,897	928,315	7,258,643	12,597,621	
OPERATING INCOME	(547,438)	613,427	639,415	323,042	162,144	275,647	176,915	1,643,151	2,736,970	
OPERATING MARGIN	(0.73)	0.50	0.50	0.30	0.15	0.30	0.19	0.23	0.22	
OPERATING INCOME (LOSS) EXCLUDING FIRE RECOVERY SURCHARGE	(629,896)	531,099	556,904	240,571	79,564	193,269	94,154	1,065,666	1,736,970	61%

COMMENTS

REVENUE/EXPENSES:

Please refer to the current month analysis for any further detail on revenue or expenses.

GENERAL/PROCESS:

There are annual/one-time expenses paid upfront that could cause individual months to appear skewed or accrual based accounting that will impact June/July more so. An example of this would be some insurances are paid in July, this causes July expenses to appear higher than other months. The District operates on an annual budget and performs accrual based accounting procedures for a hard year end close, this is typical for governmental accounting.

Data is continuously being reviewed, so it is not un-common for a prior report balance to change slightly throughout the year as accounts are reconciled.

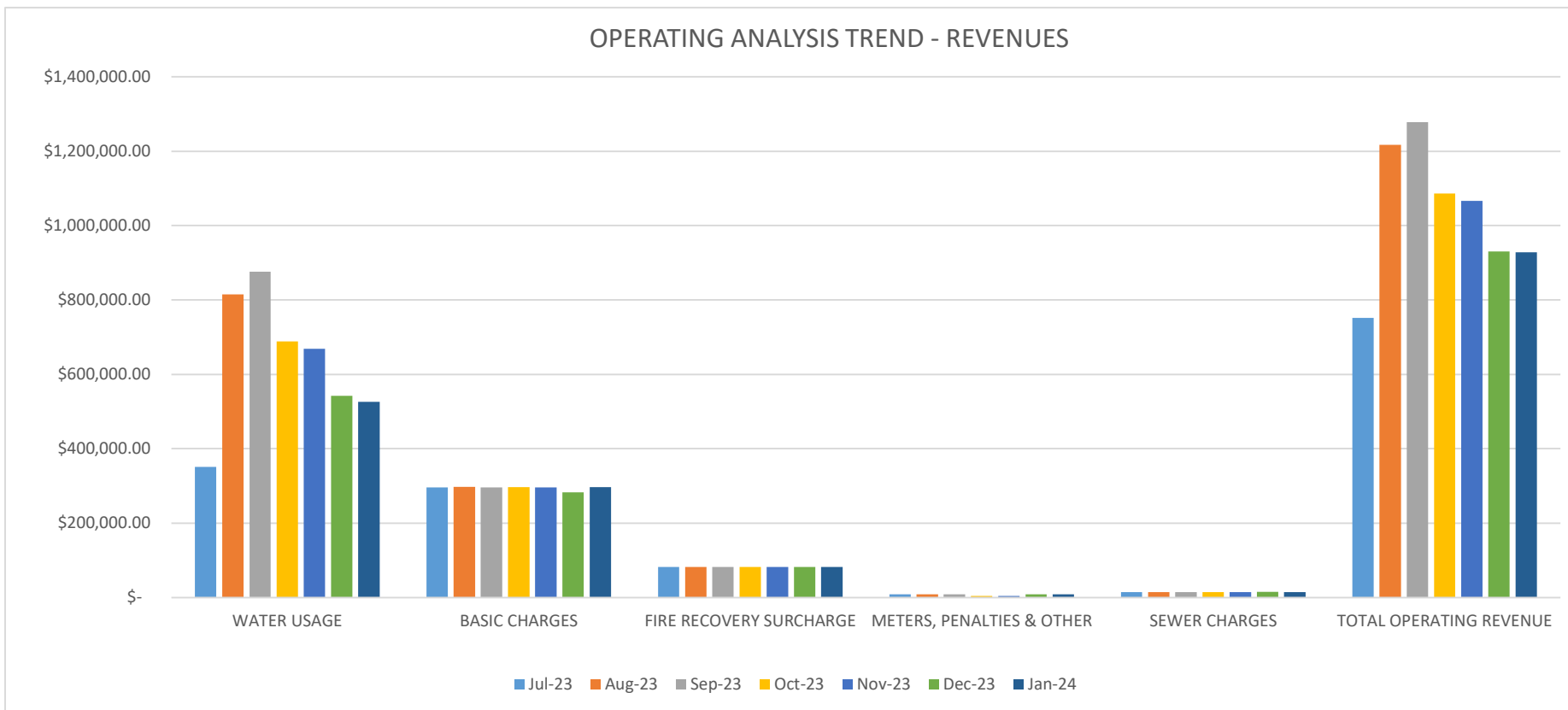

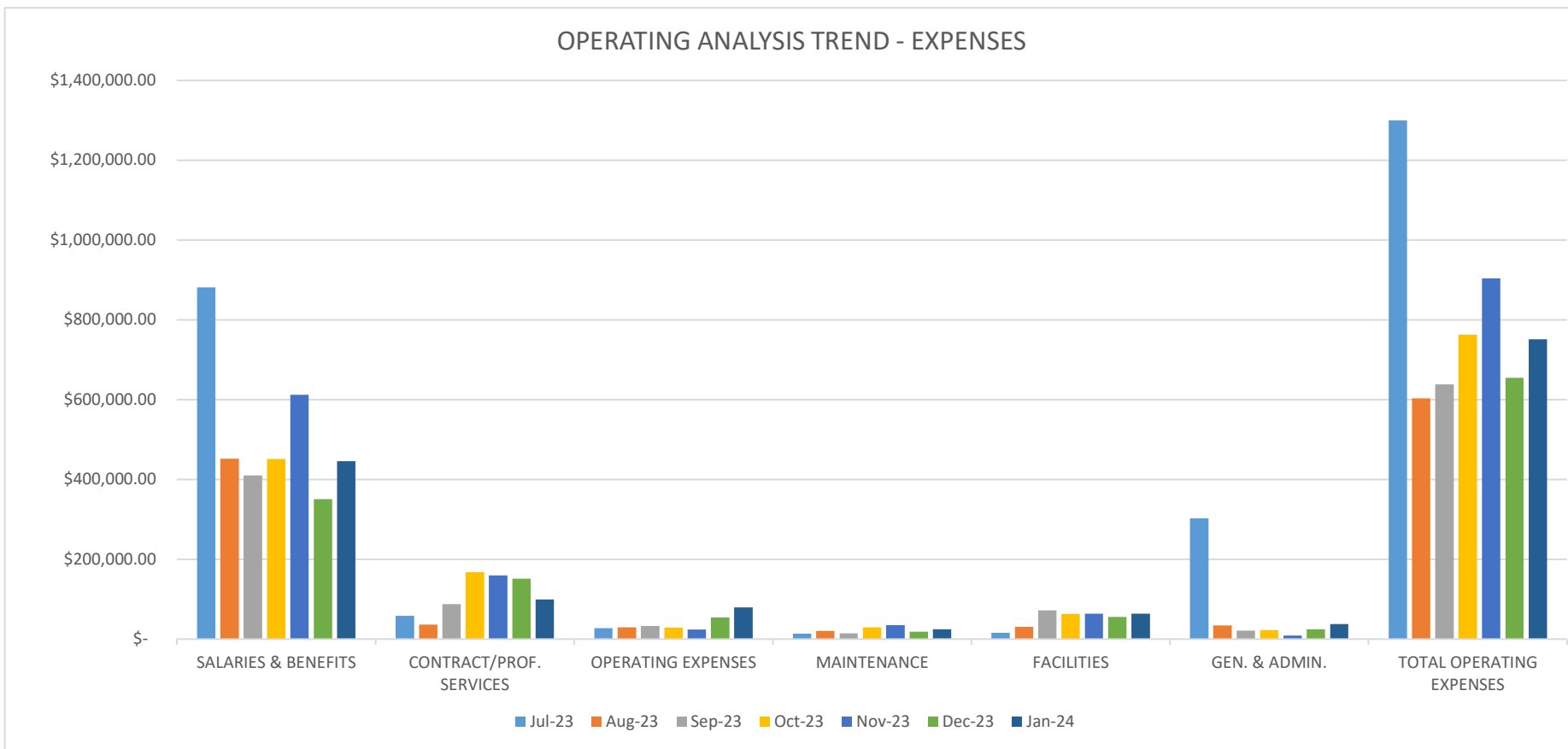

OPERATING EXPENSE ANALYSIS - Q2

DETAILED EXPENSES BY DEPARTMENT

ADMINISTRATIVE	Q2 CY ACTUALS	Q2 % of Budget	YTD ACTUALS	YTD % of Budget	ANNUAL BUDGET
SALARIES & BENEFITS	\$ 142,433	18%	\$ 377,599	48%	\$ 784,326
CONTRACT/PROFESSIONAL SERVICES	\$ 171,660	37%	\$ 246,789	53%	\$ 461,320
OPERATING EXPENSES	\$ 2,539	57%	\$ 3,960	89%	\$ 4,468
MAINTENANCE	\$ 32,683	151%	\$ 38,013	176%	\$ 21,597
FACILITIES	\$ 4,729	20%	\$ 10,179	43%	\$ 23,876
GEN. & ADMIN.	\$ 14,098	5%	\$ 303,691	99%	\$ 306,743
TOTAL ADMINISTRATIVE	\$ 368,142	23%	\$ 980,231	61%	\$ 1,602,330

FINANCE	Q2 CY ACTUALS	Q2 % of Budget	YTD ACTUALS	YTD % of Budget	ANNUAL BUDGET
SALARIES & BENEFITS	\$ 315,503	25%	\$ 601,226	47%	\$ 1,279,255
CONTRACT/PROFESSIONAL SERVICES	\$ 114,451	64%	\$ 137,180	77%	\$ 177,462
OPERATING EXPENSES	\$ 940	16%	\$ 2,765	46%	\$ 5,958
MAINTENANCE	\$ 4,439	43%	\$ 6,485	63%	\$ 10,277
FACILITIES	\$ 1,348	91%	\$ 3,329	223%	\$ 1,489
GEN. & ADMIN.	\$ 33,882	20%	\$ 80,410	48%	\$ 167,424
TOTAL FINANCE	\$ 470,564	29%	\$ 831,393	51%	\$ 1,641,865

ENGINEERING	Q2 CY ACTUALS	Q2 % of Budget	YTD ACTUALS	YTD % of Budget	ANNUAL BUDGET
SALARIES & BENEFITS	\$ 149,528	24%	\$ 260,588	43%	\$ 611,533
CONTRACT/PROFESSIONAL SERVICES	\$ 340	2%	\$ 10,486	61%	\$ 17,300
OPERATING EXPENSES	\$ -	0%	\$ -	0%	\$ 1,000
MAINTENANCE	\$ 3,122	16%	\$ 5,633	28%	\$ 20,000
FACILITIES	\$ 1,108	111%	\$ 2,479	248%	\$ 1,000
GEN. & ADMIN.	\$ 632	11%	\$ 1,195	20%	\$ 6,000
TOTAL ENGINEERING	\$ 154,730	24%	\$ 280,382	43%	\$ 656,833

DISTRIBUTION	Q2 CY ACTUALS	Q2 % of Budget	YTD ACTUALS	YTD % of Budget	ANNUAL BUDGET
SALARIES & BENEFITS	\$ 457,367	23%	\$ 1,092,831	56%	\$ 1,947,801
CONTRACT/PROFESSIONAL SERVICES	\$ 48,401	32%	\$ 63,043	42%	\$ 150,000
OPERATING EXPENSES	\$ 39,944	21%	\$ 72,859	39%	\$ 189,000
MAINTENANCE	\$ 29,038	25%	\$ 50,402	44%	\$ 114,189
FACILITIES	\$ 63,326	28%	\$ 111,621	49%	\$ 229,436
GEN. & ADMIN.	\$ 661	8%	\$ 1,044	13%	\$ 7,944
TOTAL DISTRIBUTION	\$ 638,737	24%	\$ 1,391,800	53%	\$ 2,638,370

WATERSHED	Q2 CY ACTUALS	Q2 % of Budget	YTD ACTUALS	YTD % of Budget	ANNUAL BUDGET
SALARIES & BENEFITS	\$ 56,100	32%	\$ 88,763	51%	\$ 172,789
CONTRACT/PROFESSIONAL SERVICES	\$ 100,884	45%	\$ 110,245	50%	\$ 222,500
OPERATING EXPENSES	\$ 1,252	66%	\$ 1,252	66%	\$ 1,900
MAINTENANCE	\$ -	0%	\$ -	0%	\$ 7,500
FACILITIES	\$ 567	52%	\$ 920	85%	\$ 1,080
GEN. & ADMIN.	\$ 803	4%	\$ 6,682	35%	\$ 19,300
TOTAL WATERSHED	\$ 159,606	38%	\$ 207,862	49%	\$ 425,069

DETAILED EXPENSES BY DEPARTMENT (continued)

SUPPLY & TREATMENT	Q2 CY ACTUALS	Q2 % of Budget	YTD ACTUALS	YTD % of Budget	ANNUAL BUDGET
SALARIES & BENEFITS	\$ 291,705	16%	\$ 735,446	39%	\$ 1,880,379
CONTRACT/PROFESSIONAL SERVICES	\$ 33,046	19%	\$ 75,937	45%	\$ 170,000
OPERATING EXPENSES	\$ 48,432	21%	\$ 101,452	44%	\$ 230,000
MAINTENANCE	\$ 14,716	23%	\$ 32,297	51%	\$ 63,052
FACILITIES	\$ 109,337	26%	\$ 169,473	40%	\$ 424,471
GEN. & ADMIN.	\$ 676	10%	\$ 4,075	63%	\$ 6,454
TOTAL SUPPLY & TREATMENT	\$ 497,912	18%	\$ 1,118,680	40%	\$ 2,774,357

WASTEWATER	Q2 CY ACTUALS	Q2 % of Budget	YTD ACTUALS	YTD % of Budget	ANNUAL BUDGET
SALARIES & BENEFITS	\$ 1,802	5%	\$ 1,802	5%	\$ 33,919
CONTRACT/PROFESSIONAL SERVICES	\$ 12,951	33%	\$ 20,127	51%	\$ 39,231
OPERATING EXPENSES	\$ 14,019	44%	\$ 14,669	46%	\$ 32,074
MAINTENANCE	\$ -	0%	\$ -	0%	\$ 2,984
FACILITIES	\$ 1,713	14%	\$ 3,569	29%	\$ 12,273
GEN. & ADMIN.	\$ -	0%	\$ -	0%	\$ 1,346
TOTAL WASTEWATER	\$ 30,485	25%	\$ 40,167	33%	\$ 121,827

TOTAL OPERATING EXPENSES	\$ 2,320,176	24%	\$ 4,850,515	49%	\$ 9,860,651
---------------------------------	---------------------	------------	---------------------	------------	---------------------

REBATE PROGRAM

BUDGETED AMOUNT FY2324 = \$4000

Q1 ENDING 9/30/2023

Code	Type	# Rebates	Amount
RBDRIPsqft	Drip		
RBHECW	Clothes Washer	12	\$ 1,200.00
RBHWRS	Recirculation System		
RBLAWN	Lawn		
RBT1.6	Toilet 1.6	2	\$ 150.00
RBT3.5	Toilet 3.5	4	\$ 798.00
RBWBICSI	Irrigation Controller	2	\$ 244.00
RBGWLL	Greywater Irrigation		
		20	\$ 2,392.00

Q2 ENDING 12/31/2023

Code	Type	# Rebates	Amount
RBDRIPsqft	Drip		
RBHECW	Clothes Washer	3	\$ 300.00
RBHWRS	Recirculation System		
RBLAWN	Lawn		
RBT1.6	Toilet 1.6	1	\$ 75.00
RBT3.5	Toilet 3.5	1	\$ 200.00
RBWBICSI	Irrigation Controller		
RBGWLL	Greywater Irrigation		
		5	\$ 575.00

ANNUAL SUMMARY FY2324

Code	Type	# Rebates	Amount
RBDRIPsqft	Drip	-	\$ -
RBHECW	Clothes Washer	15	\$ 1,500.00
RBHWRS	Recirculation System	-	\$ -
RBLAWN	Lawn	-	\$ -
RBT1.6	Toilet 1.6	3	\$ 225.00
RBT3.5	Toilet 3.5	5	\$ 998.00
RBWBICSI	Irrigation Controller	2	\$ 244.00
RBGWLL	Greywater Irrigation	-	\$ -
		25	\$ 2,967.00

OTHER EXPENDITURES	AMOUNT
TOILET DISPOSAL	\$ 224.00
CONSERVATION DEVICES	\$ 96.40
PY FIX	0
OVERALL BALANCE WATER CONSERVATION PROGRAM	\$ 3,287.40

CASH BALANCES AS OF

1/31/2024

	CASH BALANCE	Ave Interest Rate	Maturity Date
OPERATING ACCOUNTS			
Wells Fargo Checking	\$ 2,130,522	0.25%	N/A
LAIF	\$ 87,938	4.01%	N/A
SCCF General	\$ 3,964,460	3.91%	N/A
OPERATING BALANCE	\$ 6,182,920		
RESTRICTED ACCOUNTS			
SCCF Lompico Assessment District	\$ 273,094		<i>For AD Projects</i>
SCCF Olympia Assessment District	\$ 53,798		<i>For Debt Repayment</i>
WF \$15M CoBank Loan Proceeds*	\$ 5,529,389	4.50%	<i>Loan Proceeds</i>
WF \$14.5M COP Proceeds*	\$ 5,181,615	4.50%	<i>Loan Proceeds</i>
Watershed Endowment	\$ 32,095	0.25%	<i>Watershed maint.</i>
CB&T Escrow Fund SRF	\$ 115,390	0.13%	<i>For Debt Repayment</i>
CB&T Escrow Fund DOWR	\$ 185,439	0.13%	<i>For Debt Repayment</i>
Fire Recovery Surcharge	\$ 464,653	0.25%	<i>For CZU Fire Related Expenses</i>
RESTRICTED BALANCE	\$ 11,835,475		

* Includes outstanding transfers totaling \$2,153,436

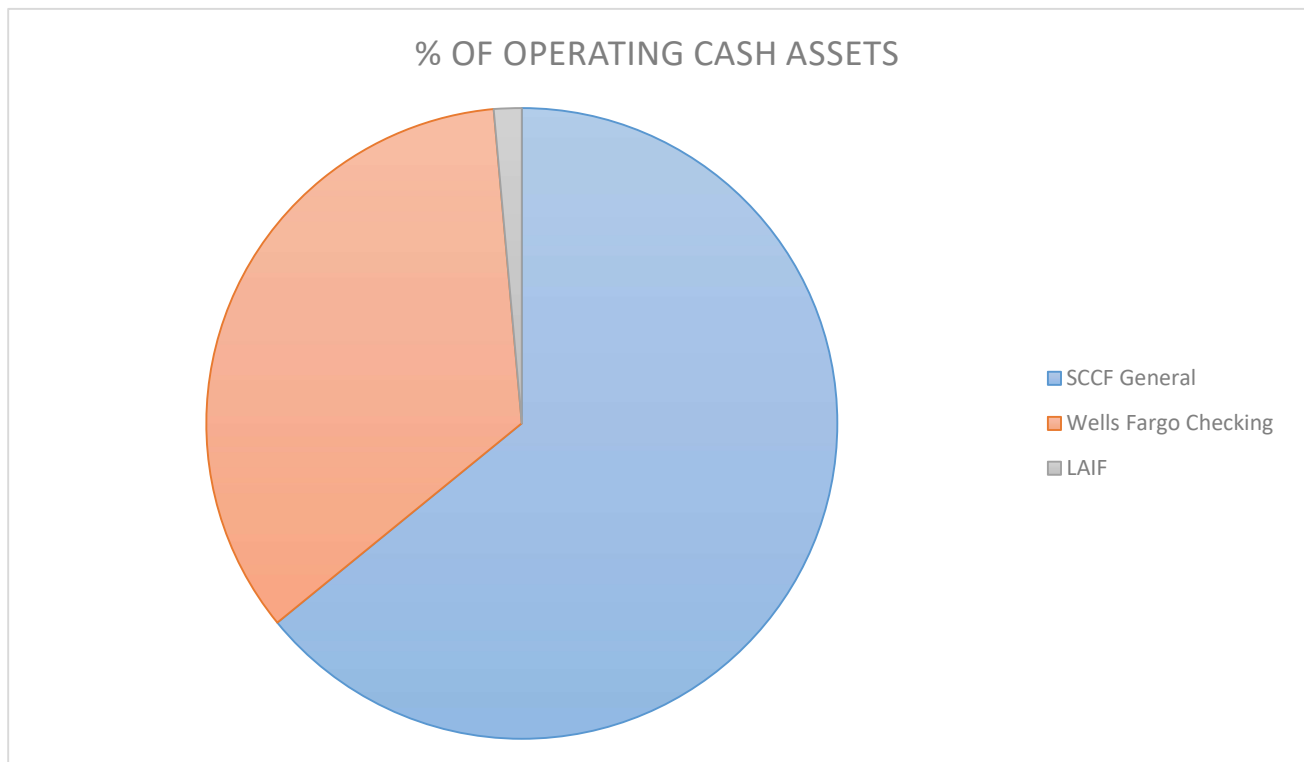



Wells Fargo Bank, N.A.
PO BOX 5120
SIOUX FALLS, SD 57117-5120
1-800-645-3751

Agenda: 4.4.24
Item: 12.3

BR STMT SAN LORENZO VALLEY WATER DISTRICT
13060 HIGHWAY 9
BOULDER CREEK, CA 95005



Enclosed is your Wells Fargo Bank, N.A. account statement. If you have elected Wells Fargo Bank, N.A. (WFB) as the safekeeping agent for your securities, then also enclosed is 1) a separate WFB safekeeping statement and 2) a page summarizing activity and investments in your WFBNA account and its related WFB account.

If you have multiple WFBNA accounts and have requested "house-holding," we have included the statements that pertain to those accounts in this single envelope.

Investments, other than Brokered Certificates of Deposits, are not FDIC insured, may lose value, and are not bank guaranteed - see important disclosures on the reverse of your account summary page.



Wells Fargo Bank, N.A.
45 FREMONT ST
FLOOR 34
SAN FRANCISCO, CA 94105-2204

WILLIAMS/LEWIS
1-415-644-9152

Combined Summary Brokerage Account and Bank Account

Statement Period
01/01/2024 - 01/31/2024

SAN LORENZO VALLEY WATER DISTRICT **Account Number**
13060 HIGHWAY 9 1BD06967

Total Account Value Summary - US Dollar (USD)

This summary does not reflect the value of unpriced securities. Repurchase agreements are reflected at par value.

	Amount Last Statement Period	Amount This Statement Period	% Portfolio
Cash	\$ 0.00	\$ 0.00	0%
Money Market Mutual Funds	5,457,794.92	5,181,615.02	100%
Bonds	0.00	0.00	0%
Stocks	0.00	0.00	0%
Total Account Value	\$ 5,457,794.92	\$ 5,181,615.02	100%

Value Change Since Last Statement Period \$ (276,179.90)

Percent Decrease Since Last Statement Period 5%

Value Last Year-End \$ 5,457,794.92

Percent Decrease Since Last Year-End 5%

***Includes amortized Par value of municipal leases and notes.

Total Income Summary USD

	This Period	Year-To-Date
Interest	\$ 0.00	\$ 0.00
Dividends/Capital Gains	0.00	0.00
Money Market Mutual Funds Dividends	20,385.03	20,385.03
Other	0.00	0.00
Income Total	\$ 20,385.03	\$ 20,385.03

Total Interest Charged USD

Description	This Period
Debit Interest For January 2024	0.00
Total Interest Charged	\$ 0.00

Total Money Market Mutual Funds Summary USD

Description	Amount
Opening Balance	\$ 5,457,794.92
Deposits and Other Additions	0.00
Distributions and Other Subtractions	(296,564.93)
Dividends Reinvested	20,385.03
Change in Value	0.00
Closing Balance	\$ 5,181,615.02



Wells Fargo Securities, LLC
 45 FREMONT ST
 FLOOR 34
 SAN FRANCISCO, CA 94105-2204

WILLIAMS/LEWIS
 1-415-644-9152

Brokerage Account Statement Wells Fargo Securities, LLC

Statement Period
01/01/2024 - 01/31/2024

SAN LORENZO VALLEY WATER DISTRICT
 13060 HIGHWAY 9

Account Number
 1BD06967

Account Value Summary *USD*

This summary does not reflect the value of unpriced securities. Repurchase agreements are reflected at par value.

	Amount Last Statement Period	Amount This Statement Period	% Portfolio
Cash	\$ 0.00	\$ 0.00	0%
Money Market Mutual Funds	0.00	0.00	0%
Bonds	0.00	0.00	0%
Stocks	0.00	0.00	0%
Total Account Value	\$ 0.00	\$ 0.00	0%
Value Change Since Last Statement Period		\$ 0.00	
Percent Increase Since Last Statement Period			N/A
Value Last Year-End		\$ 0.00	
Percent Increase Since Last Year-End			N/A

Income Summary *USD*

	This Period	Year-To-Date
Interest	\$ 0.00	\$ 0.00
Dividends/Capital Gains	0.00	0.00
Money Market Mutual Funds Dividends	0.00	0.00
Other	0.00	0.00
Income Total	\$ 0.00	\$ 0.00

Interest Charged *USD*

Description	This Period
Debit Interest For January 2024	0.00
Total Interest Charged	\$ 0.00

Money Market Mutual Funds Summary *USD*

Description	Amount
Opening Balance	\$ 0.00
Deposits and Other Additions	0.00
Distributions and Other Subtractions	0.00
Dividends Reinvested	0.00
Change in Value	0.00
Closing Balance	\$ 0.00

Important Information

This statement is provided to customers of Wells Fargo Securities, LLC ("WFS"), or customers of affiliated broker-dealers whose accounts are introduced to and carried by WFS. Statements are provided monthly for accounts with transactions and/or security positions. The account statement contains a list of securities held in custody by WFS as of the statement date and provides details of purchase and sale transactions, the receipt and disbursement of cash and securities, and other activities relating to the account during the statement period.

For WFS customers who choose to maintain a safekeeping account at Wells Fargo Bank, N.A. ("Bank"), this statement is accompanied by a separate Bank safekeeping statement. The Bank safekeeping statement, if applicable, contains a list of securities held in safekeeping by the Bank as of the statement date.

Pricing: Security and other asset prices shown on the statement are obtained from independent vendors or internal pricing models. While we believe the prices are reliable, we cannot guarantee their accuracy. The prices indicated herein are as of the stated valuation date, which may not be the date of this statement, and are subject to change without notice. For exchange-listed securities, the price provided is the closing price at month end. For unlisted securities, it is the "bid" price at month end. The prices of CDs that mature in one year or less are shown at last price traded. The prices of CDs that mature in greater than one year and of other instruments that trade infrequently are estimated using similar securities for which prices are available. Prices on the statement may not necessarily be obtained when the asset is sold.

Brokered CD Pricing: Like bonds, brokered CDs are subject to price fluctuation and the value of a CD, if sold prior to maturity, may be less than at the time of its purchase. Significant loss of principal could result. While WFS generally makes a market in CDs it underwrites, the secondary market for CDs that it does not underwrite may be very limited. In those cases, WFS will use its best efforts to help investors find a buyer.

SIPC: WFS is a member of the Securities Investor Protection Corporation ("SIPC"). In the event of insolvency or liquidation of WFS, securities held in safekeeping at WFS are covered by SIPC against the loss, but not investment risk, up to a maximum of \$500,000 per customer, which includes a \$250,000 limit on claims for cash held in the account. SIPC protection does not provide any protection whatsoever against investment risk, including the loss of principal on an investment. This coverage does not apply to securities held in safekeeping by the Bank. Additional information about SIPC, including a SIPC brochure, may be obtained by visiting www.sipc.org or by calling SIPC at 1-202-371-8300.

FINRA BrokerCheck Program: WFS is a member of the Financial Industry Regulatory Authority (FINRA). Under its BrokerCheck program, FINRA provides certain information regarding the disciplinary history of broker/dealers and their associated persons. Information can be obtained from the FINRA BrokerCheck program hotline number (1-800-289-9999) or the FINRA website (www.finra.org). A brochure describing the FINRA BrokerCheck program will be furnished upon written request.

Free Credit Balances: Any customer free credit balances may be used in the business of WFS subject to limitations imposed by Rule 15c3-3 under the Securities Exchange Act of 1934. On demand, a customer has the right to receive delivery of the following: any free credit balances to which he or she is entitled, any fully paid securities to which he or she is entitled, and any securities purchased on margin upon full payment of indebtedness to WFS.

Equity Order Routing: WFS customers may request additional order routing information with respect to SEC Rule 606 by contacting their WFS sales representative. There are two reports available to WFS customers under amended Rule 606: (i) the 606(b)(1) held on-demand customer report and (ii) the 606(b)(3) not held on-demand customer report in the six months prior to the request. These reports can be found at <https://www.wellsfargo.com/com/securities/regulatory>

Equity Extended Hours Trading: See important information relating to equities trading before and after regular trading hours at: www.wellsfargo.com/com/securities/regulatory.

Equity Open Orders: Open orders will remain in effect until executed or canceled by you. Failure to cancel an open order may result in the transaction being executed for your account. WFS has no responsibility to cancel an open order at its own initiative.

Dividend Reinvestment: In any dividend reinvestment transaction, WFS acted as agent. Additional information regarding transactions of this nature will be furnished to a customer upon written request.

Account Transfers: A fee will be charged to customers transferring their existing WFS account to another broker/dealer or any other financial institution.

Non-deposit investment products recommended, offered or sold by WFS, including mutual funds, are not federally insured or guaranteed by or obligations of the Federal Deposit Insurance Corporation ("FDIC"), the Federal Reserve System or any other agency; are not bank deposits; are not obligations of, or endorsed or guaranteed in any way by any bank or WFS; and are subject to risk, including the possible loss of principal, that may cause the value of the investment and investment return to fluctuate.

When the investment is sold, the value may be higher or lower than the amount originally invested. WFS is a subsidiary of Wells Fargo & Company, is not a bank or thrift, and is separate from any other affiliated bank or thrift. WFS is a registered broker-dealer and member of FINRA. No affiliate of WFS is responsible for the securities sold by WFS.

Trade Confirmations: Investment purchases and sales are subject to the terms and conditions stated on the trade confirmation relating to that transaction. In the event of a conflict between the trade confirmation and this statement, the trade confirmation will govern.

Listed Options: Commissions and other charges related to the execution of listed option transactions have been included in confirmations of such transactions that have been previously furnished and are available upon request. Promptly advise your WFS sales representative of any material change in your investment objectives or financial situation.

Financial Statements: WFS financial statements are available upon request.

Customer Complaints and Reporting Discrepancies: Customer complaints, statement reporting inaccuracies or discrepancies should be promptly reported in writing to:

Customer Service
90 South 7th Street
5th Floor, MAC N9305-05F
Minneapolis, MN 55402
wfscustomerservice@wellsfargo.com

In the event your account is introduced to WFS by an affiliated broker-dealer as indicated on page 1 of your statement, you should also send a copy of your written correspondence to that introducing broker-dealer at the address appearing on that page.

Customers may also report complaints, inaccuracies or discrepancies by calling 1-800-645-3751 option 5. To further protect their rights, including rights under the Securities Investor Protection Act, customers should also re-confirm in writing to the above address any oral communications with WFS relating to the inaccuracies or discrepancies.

Mutual Funds: Institutional Prime and Institutional Tax Exempt money market mutual funds are required to price and transact at a net asset value ("NAV") per share that fluctuates based upon the pricing of the underlying portfolio of securities and this requirement may impact the value of those fund shares. Additionally, Institutional Prime and Institutional Tax-Exempt funds may be subject to redemption fees and/or gates that can affect the availability of funds invested.

Mutual funds are sold by prospectus, which includes more complete information on risks, charges, expenses and other matters of interest. Investors should read the prospectus carefully before investing.

Muni Substitute Interest: With respect to transactions involving your purchase of a municipal security having interest that is exempt from federal and/or state income taxes, if you do not receive good delivery of such securities on settlement date (i.e., all requirements for transferring title from the seller to the buyer have occurred), the interest that you accrue from the settlement date of the transaction until you receive good delivery may be considered by the Internal Revenue Service ("IRS") to be taxable ("substitute") interest. If you sell such securities before receiving good delivery, the IRS may consider all of the interest that you accrue to be taxable. You should consult with your tax advisors regarding the tax implication of any such fail to receive scenario.



Wells Fargo Bank, N.A.
 45 FREMONT ST
 FLOOR 34
 SAN FRANCISCO, CA 94105-2204

WILLIAMS/LEWIS
 1-415-644-9152

Bank Account Statement
Wells Fargo Bank, N.A.

Statement Period
01/01/2024 - 01/31/2024

SAN LORENZO VALLEY WATER DISTRICT
 13060 HIGHWAY 9

Account Number
 1BD06967

Account Value Summary *USD*

This summary does not reflect the value of unpriced securities. Repurchase agreements are reflected at par value.

	Amount Last Statement Period	Amount This Statement Period	% Portfolio
Cash	\$ 0.00	\$ 0.00	0%
Money Market Mutual Funds	5,457,794.92	5,181,615.02	100%
Bonds	0.00	0.00	0%
Stocks	0.00	0.00	0%
Total Account Value	\$ 5,457,794.92	\$ 5,181,615.02	100%

Value Change Since Last Statement Period	\$ (276,179.90)
Percent Decrease Since Last Statement Period	5%
Value Last Year-End	\$ 5,457,794.92
Percent Decrease Since Last Year-End	5%

Income Summary *USD*

	This Period	Year-To-Date
Interest	\$ 0.00	\$ 0.00
Dividends/Capital Gains	0.00	0.00
Money Market Mutual Funds Dividends	20,385.03	20,385.03
Other	0.00	0.00
Income Total	\$ 20,385.03	\$ 20,385.03

Interest Charged *USD*

Description	This Period
Debit Interest For January 2024	0.00
Total Interest Charged	\$ 0.00

Money Market Mutual Funds Summary *USD*

Description	Amount
Opening Balance	\$ 5,457,794.92
Deposits and Other Additions	0.00
Distributions and Other Subtractions	(296,564.93)
Dividends Reinvested	20,385.03
Change in Value	0.00
Closing Balance	\$ 5,181,615.02

Important Information

This statement is provided to customers of Wells Fargo Bank, N.A. (the "Bank"). Statements are provided monthly for accounts with transactions and/or security positions.

Pricing: Security and other asset prices shown on the statement are obtained from independent vendors or internal pricing models. While we believe the prices are reliable, we cannot guarantee their accuracy. The prices indicated herein are as of the stated valuation date, which may not be the date of this statement, and are subject to change without notice. For exchange-listed securities, the price provided is the closing price of the relevant security at month end. For unlisted securities, it is the "bid" price of the relevant security at month end. The prices of instruments that trade infrequently are estimated using similar securities for which prices are available. Prices on the statement may not necessarily be obtained when the asset is sold.

Cash Balances: Cash held at the Bank is not covered by SIPC, but is instead eligible for FDIC insurance of up to \$250,000 per depositor, per institution, in accordance with FDIC rules.

Mutual Funds: You have the right, in the course of normal business operations, to withdraw balances in the Bank Deposit Sweep or redeem shares of the money market mutual fund used in the sweep, subject to any open commitments in any of your accounts and have the proceeds returned to your accounts or remitted to you. Note, however, that as required by federal banking regulations, the banks in the Bank Deposit Sweep reserve the right to require seven days prior notice before permitting a transfer out of the Bank Deposit Sweep. In addition, the money market mutual funds in the sweep reserve the right to require one or more day's prior notice before permitting withdrawals.

The Bank makes certain money market mutual funds available through the Bank Deposit Sweep and has

entered into agreements with the mutual fund companies with respect to the available funds. Mutual funds are sold by prospectus only. Please read the prospectus for further information including sales charges, deferred sales charges, withdrawal charges and management or other fees.

Muni Substitute Interest: With respect to transactions involving your purchase of a municipal security having interest that is exempt from federal and/or state income taxes, if you do not receive good delivery of such securities on settlement date (i.e., all requirements for transferring title from the seller to the buyer have occurred), the interest that you accrue from the settlement date of the transaction until you receive good delivery may be considered by the Internal Revenue Service ("IRS") to be taxable ("substitute") interest. If you sell such securities before receiving good delivery, the IRS may consider all of the interest that you accrue to be taxable. You should consult with your tax advisors regarding the tax implication of any such fail to receive scenario.

Non-deposit investment products offered or sold by the Bank, including investments in mutual funds available through the Bank, are not federally insured or guaranteed by or obligations of the U.S. government, the Federal Deposit Insurance Corporation ("FDIC"), the Federal Reserve System or any other government agency; are not bank deposits; are not obligations of, or endorsed or guaranteed in any way by any bank or the Bank; and are subject to risk, including the possible loss of principal, that may cause the value of the investment and the investment return to fluctuate. When the investment is sold, the amount may be higher or lower than the amount originally invested.

Customer Complaints and Reporting Discrepancies: All inquiries, statement reporting inaccuracies or discrepancies, or complaints regarding your account or the activity therein should be directed to:

Customer Service
90 South 7th Street
5th Floor, MAC N9303-054
Minneapolis, MN 55402
1-800-645-3751, option 5,
WFSCustomerService@Wellsfargo.com.

To further protect their rights, customers should also re-confirm in writing to the above address any oral communications with the Bank relating to inaccuracies or discrepancies.

The Bank's financial statements are available upon request.

Statement Ending: January 31, 2024

SAN LORENZO VALLEY WATER DISTRICT
 Account Number: 1BD06967
Daily Account Activity

Your investment transactions during this statement period.

Cash Activity USD

Transaction / Trade Date	Settlement / Eff. Date	Activity	Description	Debit Amount / Disbursements	Credit Amount / Receipts
01/18/24	01/18/24	ACH/DDA Transaction	DESIGNATED DDA	269,910.13	
01/23/24	01/23/24	ACH/DDA Transaction	DESIGNATED DDA	9,881.06	
01/30/24	01/30/24	ACH/DDA Transaction	DESIGNATED DDA	16,773.74	

Money Market Fund Activity

JPMorgan 100%UST Ins 199

*As of January 31, 2024

USD	Dividend paid this period	7 day* simple yield	30 day* simple yield
	20,385.03	5.170%	5.170%

Transaction Date	Activity	Shares	Price	Market Value (\$)	Dividend Amount	Share Balance
	Beginning Balance		1.0000	5,457,794.92		5,457,794.92000
01/02/24	Reinvest	20,385.03000			20,385.03	5,478,179.95000
01/18/24	Redemption	(269,910.13000)		(269,910.13)		5,208,269.82000
01/23/24	Redemption	(9,881.06000)		(9,881.06)		5,198,388.76000
01/30/24	Redemption	(16,773.74000)		(16,773.74)		5,181,615.02000
	Ending Balance		1.0000	5,181,615.02		5,181,615.02000



Wells Fargo Bank, N.A.
PO BOX 5120
SIOUX FALLS, SD 57117-5120
1-800-645-3751

Agenda: 4.4.24
Item: 12.3

BR STMT SAN LORENZO VALLEY WATER DISTRICT
13060 HIGHWAY 9
BOULDER CREEK, CA 95005



Enclosed is your Wells Fargo Bank, N.A. account statement. If you have elected Wells Fargo Bank, N.A. (WFB) as the safekeeping agent for your securities, then also enclosed is 1) a separate WFB safekeeping statement and 2) a page summarizing activity and investments in your WFBNA account and its related WFB account.

If you have multiple WFBNA accounts and have requested "house-holding," we have included the statements that pertain to those accounts in this single envelope.

Investments, other than Brokered Certificates of Deposits, are not FDIC insured, may lose value, and are not bank guaranteed - see important disclosures on the reverse of your account summary page.



Wells Fargo Bank, N.A.
45 FREMONT ST
FLOOR 34
SAN FRANCISCO, CA 94105-2204

WILLIAMS/LEWIS
1-415-644-9152

Combined Summary Brokerage Account and Bank Account

Statement Period
11/01/2023 - 11/30/2023

SAN LORENZO VALLEY WATER DISTRICT
13060 HIGHWAY 9
Account Number
1BD06967

Total Account Value Summary - US Dollar (USD)

This summary does not reflect the value of unpriced securities. Repurchase agreements are reflected at par value.

	Amount Last Statement Period	Amount This Statement Period	% Portfolio
Cash	\$ 0.00	\$ 0.00	0%
Money Market Mutual Funds	4,543,261.90	4,503,211.98	83%
Bonds	927,136.25	931,297.86	17%
Stocks	0.00	0.00	0%
Total Account Value	\$ 5,470,398.15	\$ 5,434,509.84	100%
Value Change Since Last Statement Period		\$ (35,888.31)	
Percent Decrease Since Last Statement Period			1%
Value Last Year-End		\$ N/A	
Percent Increase Since Last Year-End			N/A

***Includes amortized Par value of municipal leases and notes.

Total Income Summary USD

	This Period	Year-To-Date
Interest	\$ 0.00	\$ 0.00
Dividends/Capital Gains	0.00	0.00
Money Market Mutual Funds Dividends	21,272.63	92,535.51
Other	0.00	0.00
Income Total	\$ 21,272.63	\$ 92,535.51

Total Interest Charged USD

Description	This Period
Debit Interest For November 2023	0.00
Total Interest Charged	\$ 0.00

Total Money Market Mutual Funds Summary USD

Description	Amount
Opening Balance	\$ 4,543,261.90
Deposits and Other Additions	0.00
Distributions and Other Subtractions	(61,322.55)
Dividends Reinvested	21,272.63
Change in Value	0.00
Closing Balance	\$ 4,503,211.98



Wells Fargo Securities, LLC
 45 FREMONT ST
 FLOOR 34
 SAN FRANCISCO, CA 94105-2204

WILLIAMS/LEWIS
 1-415-644-9152

Brokerage Account Statement Wells Fargo Securities, LLC

Statement Period
11/01/2023 - 11/30/2023

SAN LORENZO VALLEY WATER DISTRICT
 13060 HIGHWAY 9

Account Number
 1BD06967

Account Value Summary *USD*

This summary does not reflect the value of unpriced securities. Repurchase agreements are reflected at par value.

	Amount Last Statement Period	Amount This Statement Period	% Portfolio
Cash	\$ 0.00	\$ 0.00	0%
Money Market Mutual Funds	0.00	0.00	0%
Bonds	0.00	0.00	0%
Stocks	0.00	0.00	0%
Total Account Value	\$ 0.00	\$ 0.00	0%
Value Change Since Last Statement Period		\$ 0.00	
Percent Increase Since Last Statement Period			N/A
Value Last Year-End		\$ N/A	
Percent Increase Since Last Year-End			N/A

Income Summary *USD*

	This Period	Year-To-Date
Interest	\$ 0.00	\$ 0.00
Dividends/Capital Gains	0.00	0.00
Money Market Mutual Funds Dividends	0.00	0.00
Other	0.00	0.00
Income Total	\$ 0.00	\$ 0.00

Interest Charged *USD*

Description	This Period
Debit Interest For November 2023	0.00
Total Interest Charged	\$ 0.00

Money Market Mutual Funds Summary *USD*

Description	Amount
Opening Balance	\$ 0.00
Deposits and Other Additions	0.00
Distributions and Other Subtractions	0.00
Dividends Reinvested	0.00
Change in Value	0.00
Closing Balance	\$ 0.00

Important Information

This statement is provided to customers of Wells Fargo Securities, LLC ("WFS"), or customers of affiliated broker-dealers whose accounts are introduced to and carried by WFS. Statements are provided monthly for accounts with transactions and/or security positions. The account statement contains a list of securities held in custody by WFS as of the statement date and provides details of purchase and sale transactions, the receipt and disbursement of cash and securities, and other activities relating to the account during the statement period.

For WFS customers who choose to maintain a safekeeping account at Wells Fargo Bank, N.A. ("Bank"), this statement is accompanied by a separate Bank safekeeping statement. The Bank safekeeping statement, if applicable, contains a list of securities held in safekeeping by the Bank as of the statement date.

Pricing: Security and other asset prices shown on the statement are obtained from independent vendors or internal pricing models. While we believe the prices are reliable, we cannot guarantee their accuracy. The prices indicated herein are as of the stated valuation date, which may not be the date of this statement, and are subject to change without notice. For exchange-listed securities, the price provided is the closing price at month end. For unlisted securities, it is the "bid" price at month end. The prices of CDs that mature in one year or less are shown at last price traded. The prices of CDs that mature in greater than one year and of other instruments that trade infrequently are estimated using similar securities for which prices are available. Prices on the statement may not necessarily be obtained when the asset is sold.

Brokered CD Pricing: Like bonds, brokered CDs are subject to price fluctuation and the value of a CD, if sold prior to maturity, may be less than at the time of its purchase. Significant loss of principal could result. While WFS generally makes a market in CDs it underwrites, the secondary market for CDs that it does not underwrite may be very limited. In those cases, WFS will use its best efforts to help investors find a buyer.

SIPC: WFS is a member of the Securities Investor Protection Corporation ("SIPC"). In the event of insolvency or liquidation of WFS, securities held in safekeeping at WFS are covered by SIPC against the loss, but not investment risk, up to a maximum of \$500,000 per customer, which includes a \$250,000 limit on claims for cash held in the account. SIPC protection does not provide any protection whatsoever against investment risk, including the loss of principal on an investment. This coverage does not apply to securities held in safekeeping by the Bank. Additional information about SIPC, including a SIPC brochure, may be obtained by visiting www.sipc.org or by calling SIPC at 1-202-371-8300.

FINRA BrokerCheck Program: WFS is a member of the Financial Industry Regulatory Authority (FINRA). Under its BrokerCheck program, FINRA provides certain information regarding the disciplinary history of broker/dealers and their associated persons. Information can be obtained from the FINRA BrokerCheck program hotline number (1-800-289-9999) or the FINRA website (www.finra.org). A brochure describing the FINRA BrokerCheck program will be furnished upon written request.

Free Credit Balances: Any customer free credit balances may be used in the business of WFS subject to limitations imposed by Rule 15c3-3 under the Securities Exchange Act of 1934. On demand, a customer has the right to receive delivery of the following: any free credit balances to which he or she is entitled, any fully paid securities to which he or she is entitled, and any securities purchased on margin upon full payment of indebtedness to WFS.

Equity Order Routing: WFS customers may request additional order routing information with respect to SEC Rule 606 by contacting their WFS sales representative. There are two reports available to WFS customers under amended Rule 606: (i) the 606(b)(1) held on-demand customer report and (ii) the 606(b)(3) not held on-demand customer report in the six months prior to the request. These reports can be found at <https://www.wellsfargo.com/com/securities/regulatory>

Equity Extended Hours Trading: See important information relating to equities trading before and after regular trading hours at: www.wellsfargo.com/com/securities/regulatory.

Equity Open Orders: Open orders will remain in effect until executed or canceled by you. Failure to cancel an open order may result in the transaction being executed for your account. WFS has no responsibility to cancel an open order at its own initiative.

Dividend Reinvestment: In any dividend reinvestment transaction, WFS acted as agent. Additional information regarding transactions of this nature will be furnished to a customer upon written request.

Account Transfers: A fee will be charged to customers transferring their existing WFS account to another broker/dealer or any other financial institution.

Non-deposit investment products recommended, offered or sold by WFS, including mutual funds, are not federally insured or guaranteed by or obligations of the Federal Deposit Insurance Corporation ("FDIC"), the Federal Reserve System or any other agency; are not bank deposits; are not obligations of, or endorsed or guaranteed in any way by any bank or WFS; and are subject to risk, including the possible loss of principal, that may cause the value of the investment and investment return to fluctuate.

When the investment is sold, the value may be higher or lower than the amount originally invested. WFS is a subsidiary of Wells Fargo & Company, is not a bank or thrift, and is separate from any other affiliated bank or thrift. WFS is a registered broker-dealer and member of FINRA. No affiliate of WFS is responsible for the securities sold by WFS.

Trade Confirmations: Investment purchases and sales are subject to the terms and conditions stated on the trade confirmation relating to that transaction. In the event of a conflict between the trade confirmation and this statement, the trade confirmation will govern.

Listed Options: Commissions and other charges related to the execution of listed option transactions have been included in confirmations of such transactions that have been previously furnished and are available upon request. Promptly advise your WFS sales representative of any material change in your investment objectives or financial situation.

Financial Statements: WFS financial statements are available upon request.

Customer Complaints and Reporting Discrepancies: Customer complaints, statement reporting inaccuracies or discrepancies should be promptly reported in writing to:

Customer Service
90 South 7th Street
5th Floor, MAC N9305-05F
Minneapolis, MN 55402
wfscustomerservice@wellsfargo.com

In the event your account is introduced to WFS by an affiliated broker-dealer as indicated on page 1 of your statement, you should also send a copy of your written correspondence to that introducing broker-dealer at the address appearing on that page.

Customers may also report complaints, inaccuracies or discrepancies by calling 1-800-645-3751 option 5. To further protect their rights, including rights under the Securities Investor Protection Act, customers should also re-confirm in writing to the above address any oral communications with WFS relating to the inaccuracies or discrepancies.

Mutual Funds: Institutional Prime and Institutional Tax Exempt money market mutual funds are required to price and transact at a net asset value ("NAV") per share that fluctuates based upon the pricing of the underlying portfolio of securities and this requirement may impact the value of those fund shares. Additionally, Institutional Prime and Institutional Tax-Exempt funds may be subject to redemption fees and/or gates that can affect the availability of funds invested.

Mutual funds are sold by prospectus, which includes more complete information on risks, charges, expenses and other matters of interest. Investors should read the prospectus carefully before investing.

Muni Substitute Interest: With respect to transactions involving your purchase of a municipal security having interest that is exempt from federal and/or state income taxes, if you do not receive good delivery of such securities on settlement date (i.e., all requirements for transferring title from the seller to the buyer have occurred), the interest that you accrue from the settlement date of the transaction until you receive good delivery may be considered by the Internal Revenue Service ("IRS") to be taxable ("substitute") interest. If you sell such securities before receiving good delivery, the IRS may consider all of the interest that you accrue to be taxable. You should consult with your tax advisors regarding the tax implication of any such fail to receive scenario.



Wells Fargo Bank, N.A.
 45 FREMONT ST
 FLOOR 34
 SAN FRANCISCO, CA 94105-2204
 WILLIAMS/LEWIS
 1-415-644-9152

Bank Account Statement
Wells Fargo Bank, N.A.

Statement Period
11/01/2023 - 11/30/2023

SAN LORENZO VALLEY WATER DISTRICT
 13060 HIGHWAY 9

Account Number
 1BD06967

Account Value Summary USD

This summary does not reflect the value of unpriced securities. Repurchase agreements are reflected at par value.

	Amount Last Statement Period	Amount This Statement Period	% Portfolio
Cash	\$ 0.00	\$ 0.00	0%
Money Market Mutual Funds	4,543,261.90	4,503,211.98	83%
Bonds	927,136.25	931,297.86	17%
Stocks	0.00	0.00	0%
Total Account Value	\$ 5,470,398.15	\$ 5,434,509.84	100%
Value Change Since Last Statement Period		\$ (35,888.31)	
Percent Decrease Since Last Statement Period			1%
Value Last Year-End		\$ N/A	
Percent Increase Since Last Year-End			N/A

Income Summary USD

	This Period	Year-To-Date
Interest	\$ 0.00	\$ 0.00
Dividends/Capital Gains	0.00	0.00
Money Market Mutual Funds Dividends	21,272.63	92,535.51
Other	0.00	0.00
Income Total	\$ 21,272.63	\$ 92,535.51

Interest Charged USD

Description	This Period
Debit Interest For November 2023	0.00
Total Interest Charged	\$ 0.00

Money Market Mutual Funds Summary USD

Description	Amount
Opening Balance	\$ 4,543,261.90
Deposits and Other Additions	0.00
Distributions and Other Subtractions	(61,322.55)
Dividends Reinvested	21,272.63
Change in Value	0.00
Closing Balance	\$ 4,503,211.98

Important Information

This statement is provided to customers of Wells Fargo Bank, N.A. (the "Bank"). Statements are provided monthly for accounts with transactions and/or security positions.

Pricing: Security and other asset prices shown on the statement are obtained from independent vendors or internal pricing models. While we believe the prices are reliable, we cannot guarantee their accuracy. The prices indicated herein are as of the stated valuation date, which may not be the date of this statement, and are subject to change without notice. For exchange-listed securities, the price provided is the closing price of the relevant security at month end. For unlisted securities, it is the "bid" price of the relevant security at month end. The prices of instruments that trade infrequently are estimated using similar securities for which prices are available. Prices on the statement may not necessarily be obtained when the asset is sold.

Cash Balances: Cash held at the Bank is not covered by SIPC, but is instead eligible for FDIC insurance of up to \$250,000 per depositor, per institution, in accordance with FDIC rules.

Mutual Funds: You have the right, in the course of normal business operations, to withdraw balances in the Bank Deposit Sweep or redeem shares of the money market mutual fund used in the sweep, subject to any open commitments in any of your accounts and have the proceeds returned to your accounts or remitted to you. Note, however, that as required by federal banking regulations, the banks in the Bank Deposit Sweep reserve the right to require seven days prior notice before permitting a transfer out of the Bank Deposit Sweep. In addition, the money market mutual funds in the sweep reserve the right to require one or more day's prior notice before permitting withdrawals.

The Bank makes certain money market mutual funds available through the Bank Deposit Sweep and has

entered into agreements with the mutual fund companies with respect to the available funds. Mutual funds are sold by prospectus only. Please read the prospectus for further information including sales charges, deferred sales charges, withdrawal charges and management or other fees.

Muni Substitute Interest: With respect to transactions involving your purchase of a municipal security having interest that is exempt from federal and/or state income taxes, if you do not receive good delivery of such securities on settlement date (i.e., all requirements for transferring title from the seller to the buyer have occurred), the interest that you accrue from the settlement date of the transaction until you receive good delivery may be considered by the Internal Revenue Service ("IRS") to be taxable ("substitute") interest. If you sell such securities before receiving good delivery, the IRS may consider all of the interest that you accrue to be taxable. You should consult with your tax advisors regarding the tax implication of any such fail to receive scenario.

Non-deposit investment products offered or sold by the Bank, including investments in mutual funds available through the Bank, are not federally insured or guaranteed by or obligations of the U.S. government, the Federal Deposit Insurance Corporation ("FDIC"), the Federal Reserve System or any other government agency; are not bank deposits; are not obligations of, or endorsed or guaranteed in any way by any bank or the Bank; and are subject to risk, including the possible loss of principal, that may cause the value of the investment and the investment return to fluctuate. When the investment is sold, the amount may be higher or lower than the amount originally invested.

Customer Complaints and Reporting Discrepancies: All inquiries, statement reporting inaccuracies or discrepancies, or complaints regarding your account or the activity therein should be directed to:

Customer Service
90 South 7th Street
5th Floor, MAC N9303-054
Minneapolis, MN 55402
1-800-645-3751, option 5,
WFSCustomerService@Wellsfargo.com.

To further protect their rights, customers should also re-confirm in writing to the above address any oral communications with the Bank relating to inaccuracies or discrepancies.

The Bank's financial statements are available upon request.

Statement Ending: November 30, 2023

SAN LORENZO VALLEY WATER DISTRICT

Account Number: 1BD06967

Portfolio Holdings *Security positions held with Wells Fargo Bank N.A.*

Security ID	Description	Maturity Date	Coupon	Current Par / Original Par	Market Price*	Market Value	Original Par Pledged**	Callable
Bonds USD								
912796ZN2	UNITED STATES TREASURY BILL	12/28/23	0.000%	935,000.000	99.6040	931,297.86		
				935,000.000		931,297.86	0.00	

*See important information regarding security pricing on Page 2.

**Total amount that is pledged to or held for another party or parties. Refer to the Pledge Detail Report for more information.

Daily Account Activity

Your investment transactions during this statement period.

Cash Activity USD

Transaction / Trade Date	Settlement / Eff. Date	Activity	Description	Debit Amount / Disbursements	Credit Amount / Receipts
11/30/23	11/30/23	ACH/DDA Transaction	DESIGNATED DDA		61,322.55

Money Market Fund Activity

JPMorgan 100%UST Ins 199

*As of November 30, 2023

USD	Dividend paid this period	7 day* simple yield	30 day* simple yield
	21,272.63	5.230%	5.220%

Transaction Date	Activity	Shares	Price	Market Value (\$)	Dividend Amount	Share Balance
	Beginning Balance		1.0000	4,543,261.90		4,543,261.90000
11/01/23	Reinvest	21,272.63000			21,272.63	4,564,534.53000
11/30/23	Redemption	(61,322.55000)		(61,322.55)		4,503,211.98000
	Ending Balance		1.0000	4,503,211.98		4,503,211.98000



Wells Fargo Bank, N.A.
PO BOX 5120
SIOUX FALLS, SD 57117-5120
1-800-645-3751

Agenda: 4.4.24
Item: 12.3

BR STMT SAN LORENZO VALLEY WATER DISTRICT
13060 HIGHWAY 9
BOULDER CREEK, CA 95005



Enclosed is your Wells Fargo Bank, N.A. account statement. If you have elected Wells Fargo Bank, N.A. (WFB) as the safekeeping agent for your securities, then also enclosed is 1) a separate WFB safekeeping statement and 2) a page summarizing activity and investments in your WFBNA account and its related WFB account.

If you have multiple WFBNA accounts and have requested "house-holding," we have included the statements that pertain to those accounts in this single envelope.

Investments, other than Brokered Certificates of Deposits, are not FDIC insured, may lose value, and are not bank guaranteed - see important disclosures on the reverse of your account summary page.



Wells Fargo Bank, N.A.
45 FREMONT ST
FLOOR 34
SAN FRANCISCO, CA 94105-2204

WILLIAMS/LEWIS
1-415-644-9152

Combined Summary Brokerage Account and Bank Account

Statement Period
12/01/2023 - 12/31/2023

SAN LORENZO VALLEY WATER DISTRICT
13060 HIGHWAY 9
Account Number
1BD06967

Total Account Value Summary - US Dollar (USD)

This summary does not reflect the value of unpriced securities. Repurchase agreements are reflected at par value.

	Amount Last Statement Period	Amount This Statement Period	% Portfolio
Cash	\$ 0.00	\$ 0.00	0%
Money Market Mutual Funds	4,503,211.98	5,457,794.92	100%
Bonds	931,297.86	0.00	0%
Stocks	0.00	0.00	0%
Total Account Value	\$ 5,434,509.84	\$ 5,457,794.92	100%

Value Change Since Last Statement Period \$ 23,285.08

Percent Increase Since Last Statement Period 0%

Value Last Year-End \$ N/A

Percent Increase Since Last Year-End N/A

***Includes amortized Par value of municipal leases and notes.

Total Income Summary USD

	This Period	Year-To-Date
Interest	\$ 0.00	\$ 0.00
Dividends/Capital Gains	0.00	0.00
Money Market Mutual Funds Dividends	19,582.94	112,118.45
Other	0.00	0.00
Income Total	\$ 19,582.94	\$ 112,118.45

Total Interest Charged USD

Description	This Period
Debit Interest For December 2023	0.00
Total Interest Charged	\$ 0.00

Total Money Market Mutual Funds Summary USD

Description	Amount
Opening Balance	\$ 4,503,211.98
Deposits and Other Additions	935,000.00
Distributions and Other Subtractions	0.00
Dividends Reinvested	19,582.94
Change in Value	0.00
Closing Balance	\$ 5,457,794.92



Wells Fargo Securities, LLC
 45 FREMONT ST
 FLOOR 34
 SAN FRANCISCO, CA 94105-2204

WILLIAMS/LEWIS
 1-415-644-9152

Brokerage Account Statement Wells Fargo Securities, LLC

Statement Period
12/01/2023 - 12/31/2023

SAN LORENZO VALLEY WATER DISTRICT
 13060 HIGHWAY 9

Account Number
 1BD06967

Account Value Summary *USD*

This summary does not reflect the value of unpriced securities. Repurchase agreements are reflected at par value.

	Amount Last Statement Period	Amount This Statement Period	% Portfolio
Cash	\$ 0.00	\$ 0.00	0%
Money Market Mutual Funds	0.00	0.00	0%
Bonds	0.00	0.00	0%
Stocks	0.00	0.00	0%
Total Account Value	\$ 0.00	\$ 0.00	0%
Value Change Since Last Statement Period		\$ 0.00	
Percent Increase Since Last Statement Period			N/A
Value Last Year-End		\$ N/A	
Percent Increase Since Last Year-End			N/A

Income Summary *USD*

	This Period	Year-To-Date
Interest	\$ 0.00	\$ 0.00
Dividends/Capital Gains	0.00	0.00
Money Market Mutual Funds Dividends	0.00	0.00
Other	0.00	0.00
Income Total	\$ 0.00	\$ 0.00

Interest Charged *USD*

Description	This Period
Debit Interest For December 2023	0.00
Total Interest Charged	\$ 0.00

Money Market Mutual Funds Summary *USD*

Description	Amount
Opening Balance	\$ 0.00
Deposits and Other Additions	0.00
Distributions and Other Subtractions	0.00
Dividends Reinvested	0.00
Change in Value	0.00
Closing Balance	\$ 0.00



Important Information

This statement is provided to customers of Wells Fargo Securities, LLC ("WFS"), or customers of affiliated broker-dealers whose accounts are introduced to and carried by WFS. Statements are provided monthly for accounts with transactions and/or security positions. The account statement contains a list of securities held in custody by WFS as of the statement date and provides details of purchase and sale transactions, the receipt and disbursement of cash and securities, and other activities relating to the account during the statement period.

For WFS customers who choose to maintain a safekeeping account at Wells Fargo Bank, N.A. ("Bank"), this statement is accompanied by a separate Bank safekeeping statement. The Bank safekeeping statement, if applicable, contains a list of securities held in safekeeping by the Bank as of the statement date.

Pricing: Security and other asset prices shown on the statement are obtained from independent vendors or internal pricing models. While we believe the prices are reliable, we cannot guarantee their accuracy. The prices indicated herein are as of the stated valuation date, which may not be the date of this statement, and are subject to change without notice. For exchange-listed securities, the price provided is the closing price at month end. For unlisted securities, it is the "bid" price at month end. The prices of CDs that mature in one year or less are shown at last price traded. The prices of CDs that mature in greater than one year and of other instruments that trade infrequently are estimated using similar securities for which prices are available. Prices on the statement may not necessarily be obtained when the asset is sold.

Brokered CD Pricing: Like bonds, brokered CDs are subject to price fluctuation and the value of a CD, if sold prior to maturity, may be less than at the time of its purchase. Significant loss of principal could result. While WFS generally makes a market in CDs it underwrites, the secondary market for CDs that it does not underwrite may be very limited. In those cases, WFS will use its best efforts to help investors find a buyer.

SIPC: WFS is a member of the Securities Investor Protection Corporation ("SIPC"). In the event of insolvency or liquidation of WFS, securities held in safekeeping at WFS are covered by SIPC against the loss, but not investment risk, up to a maximum of \$500,000 per customer, which includes a \$250,000 limit on claims for cash held in the account. SIPC protection does not provide any protection whatsoever against investment risk, including the loss of principal on an investment. This coverage does not apply to securities held in safekeeping by the Bank. Additional information about SIPC, including a SIPC brochure, may be obtained by visiting www.sipc.org or by calling SIPC at 1-202-371-8300.

FINRA BrokerCheck Program: WFS is a member of the Financial Industry Regulatory Authority (FINRA). Under its BrokerCheck program, FINRA provides certain information regarding the disciplinary history of broker/dealers and their associated persons. Information can be obtained from the FINRA BrokerCheck program hotline number (1-800-289-9999) or the FINRA website (www.finra.org). A brochure describing the FINRA BrokerCheck program will be furnished upon written request.

Free Credit Balances: Any customer free credit balances may be used in the business of WFS subject to limitations imposed by Rule 15c3-3 under the Securities Exchange Act of 1934. On demand, a customer has the right to receive delivery of the following: any free credit balances to which he or she is entitled, any fully paid securities to which he or she is entitled, and any securities purchased on margin upon full payment of indebtedness to WFS.

Equity Order Routing: WFS customers may request additional order routing information with respect to SEC Rule 606 by contacting their WFS sales representative. There are two reports available to WFS customers under amended Rule 606: (i) the 606(b)(1) held on-demand customer report and (ii) the 606(b)(3) not held on-demand customer report in the six months prior to the request. These reports can be found at <https://www.wellsfargo.com/com/securities/regulatory>

Equity Extended Hours Trading: See important information relating to equities trading before and after regular trading hours at: www.wellsfargo.com/com/securities/regulatory.

Equity Open Orders: Open orders will remain in effect until executed or canceled by you. Failure to cancel an open order may result in the transaction being executed for your account. WFS has no responsibility to cancel an open order at its own initiative.

Dividend Reinvestment: In any dividend reinvestment transaction, WFS acted as agent. Additional information regarding transactions of this nature will be furnished to a customer upon written request.

Account Transfers: A fee will be charged to customers transferring their existing WFS account to another broker/dealer or any other financial institution.

Non-deposit investment products recommended, offered or sold by WFS, including mutual funds, are not federally insured or guaranteed by or obligations of the Federal Deposit Insurance Corporation ("FDIC"), the Federal Reserve System or any other agency; are not bank deposits; are not obligations of, or endorsed or guaranteed in any way by any bank or WFS; and are subject to risk, including the possible loss of principal, that may cause the value of the investment and investment return to fluctuate.

When the investment is sold, the value may be higher or lower than the amount originally invested. WFS is a subsidiary of Wells Fargo & Company, is not a bank or thrift, and is separate from any other affiliated bank or thrift. WFS is a registered broker-dealer and member of FINRA. No affiliate of WFS is responsible for the securities sold by WFS.

Trade Confirmations: Investment purchases and sales are subject to the terms and conditions stated on the trade confirmation relating to that transaction. In the event of a conflict between the trade confirmation and this statement, the trade confirmation will govern.

Listed Options: Commissions and other charges related to the execution of listed option transactions have been included in confirmations of such transactions that have been previously furnished and are available upon request. Promptly advise your WFS sales representative of any material change in your investment objectives or financial situation.

Financial Statements: WFS financial statements are available upon request.

Customer Complaints and Reporting Discrepancies: Customer complaints, statement reporting inaccuracies or discrepancies should be promptly reported in writing to:

Customer Service
90 South 7th Street
5th Floor, MAC N9305-05F
Minneapolis, MN 55402
wfscustomerservice@wellsfargo.com

In the event your account is introduced to WFS by an affiliated broker-dealer as indicated on page 1 of your statement, you should also send a copy of your written correspondence to that introducing broker-dealer at the address appearing on that page.

Customers may also report complaints, inaccuracies or discrepancies by calling 1-800-645-3751 option 5. To further protect their rights, including rights under the Securities Investor Protection Act, customers should also re-confirm in writing to the above address any oral communications with WFS relating to the inaccuracies or discrepancies.

Mutual Funds: Institutional Prime and Institutional Tax Exempt money market mutual funds are required to price and transact at a net asset value ("NAV") per share that fluctuates based upon the pricing of the underlying portfolio of securities and this requirement may impact the value of those fund shares. Additionally, Institutional Prime and Institutional Tax-Exempt funds may be subject to redemption fees and/or gates that can affect the availability of funds invested.

Mutual funds are sold by prospectus, which includes more complete information on risks, charges, expenses and other matters of interest. Investors should read the prospectus carefully before investing.

Muni Substitute Interest: With respect to transactions involving your purchase of a municipal security having interest that is exempt from federal and/or state income taxes, if you do not receive good delivery of such securities on settlement date (i.e., all requirements for transferring title from the seller to the buyer have occurred), the interest that you accrue from the settlement date of the transaction until you receive good delivery may be considered by the Internal Revenue Service ("IRS") to be taxable ("substitute") interest. If you sell such securities before receiving good delivery, the IRS may consider all of the interest that you accrue to be taxable. You should consult with your tax advisors regarding the tax implication of any such fail to receive scenario.



Wells Fargo Bank, N.A.
 45 FREMONT ST
 FLOOR 34
 SAN FRANCISCO, CA 94105-2204

WILLIAMS/LEWIS
 1-415-644-9152

Bank Account Statement Wells Fargo Bank, N.A.

Statement Period
12/01/2023 - 12/31/2023

SAN LORENZO VALLEY WATER DISTRICT
 13060 HIGHWAY 9

Account Number
 1BD06967

Account Value Summary *USD*

This summary does not reflect the value of unpriced securities. Repurchase agreements are reflected at par value.

	Amount Last Statement Period	Amount This Statement Period	% Portfolio
Cash	\$ 0.00	\$ 0.00	0%
Money Market Mutual Funds	4,503,211.98	5,457,794.92	100%
Bonds	931,297.86	0.00	0%
Stocks	0.00	0.00	0%
Total Account Value	\$ 5,434,509.84	\$ 5,457,794.92	100%
Value Change Since Last Statement Period		\$ 23,285.08	
Percent Increase Since Last Statement Period		0%	
Value Last Year-End		\$ N/A	
Percent Increase Since Last Year-End		N/A	

Income Summary *USD*

	This Period	Year-To-Date
Interest	\$ 0.00	\$ 0.00
Dividends/Capital Gains	0.00	0.00
Money Market Mutual Funds Dividends	19,582.94	112,118.45
Other	0.00	0.00
Income Total	\$ 19,582.94	\$ 112,118.45

Interest Charged *USD*

Description	This Period
Debit Interest For December 2023	0.00
Total Interest Charged	\$ 0.00

Money Market Mutual Funds Summary *USD*

Description	Amount
Opening Balance	\$ 4,503,211.98
Deposits and Other Additions	935,000.00
Distributions and Other Subtractions	0.00
Dividends Reinvested	19,582.94
Change in Value	0.00
Closing Balance	\$ 5,457,794.92

Important Information

This statement is provided to customers of Wells Fargo Bank, N.A. (the "Bank"). Statements are provided monthly for accounts with transactions and/or security positions.

Pricing: Security and other asset prices shown on the statement are obtained from independent vendors or internal pricing models. While we believe the prices are reliable, we cannot guarantee their accuracy. The prices indicated herein are as of the stated valuation date, which may not be the date of this statement, and are subject to change without notice. For exchange-listed securities, the price provided is the closing price of the relevant security at month end. For unlisted securities, it is the "bid" price of the relevant security at month end. The prices of instruments that trade infrequently are estimated using similar securities for which prices are available. Prices on the statement may not necessarily be obtained when the asset is sold.

Cash Balances: Cash held at the Bank is not covered by SIPC, but is instead eligible for FDIC insurance of up to \$250,000 per depositor, per institution, in accordance with FDIC rules.

Mutual Funds: You have the right, in the course of normal business operations, to withdraw balances in the Bank Deposit Sweep or redeem shares of the money market mutual fund used in the sweep, subject to any open commitments in any of your accounts and have the proceeds returned to your accounts or remitted to you. Note, however, that as required by federal banking regulations, the banks in the Bank Deposit Sweep reserve the right to require seven days prior notice before permitting a transfer out of the Bank Deposit Sweep. In addition, the money market mutual funds in the sweep reserve the right to require one or more day's prior notice before permitting withdrawals.

The Bank makes certain money market mutual funds available through the Bank Deposit Sweep and has

entered into agreements with the mutual fund companies with respect to the available funds. Mutual funds are sold by prospectus only. Please read the prospectus for further information including sales charges, deferred sales charges, withdrawal charges and management or other fees.

Muni Substitute Interest: With respect to transactions involving your purchase of a municipal security having interest that is exempt from federal and/or state income taxes, if you do not receive good delivery of such securities on settlement date (i.e., all requirements for transferring title from the seller to the buyer have occurred), the interest that you accrue from the settlement date of the transaction until you receive good delivery may be considered by the Internal Revenue Service ("IRS") to be taxable ("substitute") interest. If you sell such securities before receiving good delivery, the IRS may consider all of the interest that you accrue to be taxable. You should consult with your tax advisors regarding the tax implication of any such fail to receive scenario.

Non-deposit investment products offered or sold by the Bank, including investments in mutual funds available through the Bank, are not federally insured or guaranteed by or obligations of the U.S. government, the Federal Deposit Insurance Corporation ("FDIC"), the Federal Reserve System or any other government agency; are not bank deposits; are not obligations of, or endorsed or guaranteed in any way by any bank or the Bank; and are subject to risk, including the possible loss of principal, that may cause the value of the investment and the investment return to fluctuate. When the investment is sold, the amount may be higher or lower than the amount originally invested.

Customer Complaints and Reporting Discrepancies: All inquiries, statement reporting inaccuracies or discrepancies, or complaints regarding your account or the activity therein should be directed to:

Customer Service
90 South 7th Street
5th Floor, MAC N9303-054
Minneapolis, MN 55402
1-800-645-3751, option 5,
WFSCustomerService@Wellsfargo.com.

To further protect their rights, customers should also re-confirm in writing to the above address any oral communications with the Bank relating to inaccuracies or discrepancies.

The Bank's financial statements are available upon request.

Statement Ending: December 31, 2023

SAN LORENZO VALLEY WATER DISTRICT
 Account Number: 1BD06967
Daily Account Activity

Your investment transactions during this statement period.

Transaction / Trade Date	Settlement / Effective Date	Activity	Security ID	Description	Par / Quantity	Price	Principal Amount	Income Amount	Debit / Credit Amount
--------------------------	-----------------------------	----------	-------------	-------------	----------------	-------	------------------	---------------	-----------------------

Income / Payment Activity USD

12/28/23	12/28/23	Matured	912796ZN2	UNITED STATES TREASURY BILL			935,000.00		935,000.00
12/28/23	12/28/23	Matured	912796ZN2	UNITED STATES TREASURY BILL	(935,000.00)				

Money Market Fund Activity

JPMorgan 100%UST Ins 199

*As of December 31, 2023

USD	Dividend paid this period	7 day* simple yield	30 day* simple yield
	19,582.94	5.200%	5.210%

Transaction Date	Activity	Shares	Price	Market Value (\$)	Dividend Amount	Share Balance
	Beginning Balance		1.0000	4,503,211.98		4,503,211.98000
12/01/23	Reinvest	19,582.94000			19,582.94	4,522,794.92000
12/29/23	Purchase	935,000.00000		935,000.00		5,457,794.92000
	Ending Balance		1.0000	5,457,794.92		5,457,794.92000



Wells Fargo Bank, N.A.
PO BOX 5120
SIOUX FALLS, SD 57117-5120
1-800-645-3751

Agenda: 4.4.24
Item: 12.3

BR STMT SAN LORENZO VALLEY WATER DISTRICT
13060 HIGHWAY 9
BOULDER CREEK, CA 95005



Enclosed is your Wells Fargo Bank, N.A. account statement. If you have elected Wells Fargo Bank, N.A. (WFB) as the safekeeping agent for your securities, then also enclosed is 1) a separate WFB safekeeping statement and 2) a page summarizing activity and investments in your WFBNA account and its related WFB account.

If you have multiple WFBNA accounts and have requested "house-holding," we have included the statements that pertain to those accounts in this single envelope.

Investments, other than Brokered Certificates of Deposits, are not FDIC insured, may lose value, and are not bank guaranteed - see important disclosures on the reverse of your account summary page.



Wells Fargo Bank, N.A.
45 FREMONT ST
FLOOR 34
SAN FRANCISCO, CA 94105-2204

WILLIAMS/LEWIS
1-415-644-9152

Combined Summary Brokerage Account and Bank Account

Statement Period
01/01/2024 - 01/31/2024

SAN LORENZO VALLEY WATER DISTRICT
13060 HIGHWAY 9
Account Number
1BD06974

Total Account Value Summary - US Dollar (USD)

This summary does not reflect the value of unpriced securities. Repurchase agreements are reflected at par value.

	Amount Last Statement Period	Amount This Statement Period	% Portfolio
Cash	\$ 0.00	\$ 0.00	0%
Money Market Mutual Funds	5,888,762.33	3,089,292.06	54%
Bonds	2,622,895.52	2,629,370.31	46%
Stocks	0.00	0.00	0%
Total Account Value	\$ 8,511,657.85	\$ 5,718,662.37	100%

Value Change Since Last Statement Period \$ (2,792,995.48)

Percent Decrease Since Last Statement Period 33%

Value Last Year-End \$ 8,511,657.85

Percent Decrease Since Last Year-End 33%

***Includes amortized Par value of municipal leases and notes.

Total Income Summary USD

	This Period	Year-To-Date
Interest	\$ 7,501.25	\$ 7,501.25
Dividends/Capital Gains	0.00	0.00
Money Market Mutual Funds Dividends	25,804.45	25,804.45
Other	0.00	0.00
Income Total	\$ 33,305.70	\$ 33,305.70

Total Interest Charged USD

Description	This Period
Debit Interest For January 2024	0.00
Total Interest Charged	\$ 0.00

Total Money Market Mutual Funds Summary USD

Description	Amount
Opening Balance	\$ 5,888,762.33
Deposits and Other Additions	7,501.25
Distributions and Other Subtractions	(2,832,775.97)
Dividends Reinvested	25,804.45
Change in Value	0.00
Closing Balance	\$ 3,089,292.06



Wells Fargo Securities, LLC
 45 FREMONT ST
 FLOOR 34
 SAN FRANCISCO, CA 94105-2204

WILLIAMS/LEWIS
 1-415-644-9152

Brokerage Account Statement Wells Fargo Securities, LLC

Statement Period
01/01/2024 - 01/31/2024

SAN LORENZO VALLEY WATER DISTRICT
 13060 HIGHWAY 9

Account Number
 1BD06974

Account Value Summary *USD*

This summary does not reflect the value of unpriced securities. Repurchase agreements are reflected at par value.

	Amount Last Statement Period	Amount This Statement Period	% Portfolio
Cash	\$ 0.00	\$ 0.00	0%
Money Market Mutual Funds	0.00	0.00	0%
Bonds	0.00	0.00	0%
Stocks	0.00	0.00	0%
Total Account Value	\$ 0.00	\$ 0.00	0%
Value Change Since Last Statement Period		\$ 0.00	
Percent Increase Since Last Statement Period			N/A
Value Last Year-End		\$ 0.00	
Percent Increase Since Last Year-End			N/A

Income Summary *USD*

	This Period	Year-To-Date
Interest	\$ 0.00	\$ 0.00
Dividends/Capital Gains	0.00	0.00
Money Market Mutual Funds Dividends	0.00	0.00
Other	0.00	0.00
Income Total	\$ 0.00	\$ 0.00

Interest Charged *USD*

Description	This Period
Debit Interest For January 2024	0.00
Total Interest Charged	\$ 0.00

Money Market Mutual Funds Summary *USD*

Description	Amount
Opening Balance	\$ 0.00
Deposits and Other Additions	0.00
Distributions and Other Subtractions	0.00
Dividends Reinvested	0.00
Change in Value	0.00
Closing Balance	\$ 0.00



Important Information

This statement is provided to customers of Wells Fargo Securities, LLC ("WFS"), or customers of affiliated broker-dealers whose accounts are introduced to and carried by WFS. Statements are provided monthly for accounts with transactions and/or security positions. The account statement contains a list of securities held in custody by WFS as of the statement date and provides details of purchase and sale transactions, the receipt and disbursement of cash and securities, and other activities relating to the account during the statement period.

For WFS customers who choose to maintain a safekeeping account at Wells Fargo Bank, N.A. ("Bank"), this statement is accompanied by a separate Bank safekeeping statement. The Bank safekeeping statement, if applicable, contains a list of securities held in safekeeping by the Bank as of the statement date.

Pricing: Security and other asset prices shown on the statement are obtained from independent vendors or internal pricing models. While we believe the prices are reliable, we cannot guarantee their accuracy. The prices indicated herein are as of the stated valuation date, which may not be the date of this statement, and are subject to change without notice. For exchange-listed securities, the price provided is the closing price at month end. For unlisted securities, it is the "bid" price at month end. The prices of CDs that mature in one year or less are shown at last price traded. The prices of CDs that mature in greater than one year and of other instruments that trade infrequently are estimated using similar securities for which prices are available. Prices on the statement may not necessarily be obtained when the asset is sold.

Brokered CD Pricing: Like bonds, brokered CDs are subject to price fluctuation and the value of a CD, if sold prior to maturity, may be less than at the time of its purchase. Significant loss of principal could result. While WFS generally makes a market in CDs it underwrites, the secondary market for CDs that it does not underwrite may be very limited. In those cases, WFS will use its best efforts to help investors find a buyer.

SIPC: WFS is a member of the Securities Investor Protection Corporation ("SIPC"). In the event of insolvency or liquidation of WFS, securities held in safekeeping at WFS are covered by SIPC against the loss, but not investment risk, up to a maximum of \$500,000 per customer, which includes a \$250,000 limit on claims for cash held in the account. SIPC protection does not provide any protection whatsoever against investment risk, including the loss of principal on an investment. This coverage does not apply to securities held in safekeeping by the Bank. Additional information about SIPC, including a SIPC brochure, may be obtained by visiting www.sipc.org or by calling SIPC at 1-202-371-8300.

FINRA BrokerCheck Program: WFS is a member of the Financial Industry Regulatory Authority (FINRA). Under its BrokerCheck program, FINRA provides certain information regarding the disciplinary history of broker/dealers and their associated persons. Information can be obtained from the FINRA BrokerCheck program hotline number (1-800-289-9999) or the FINRA website (www.finra.org). A brochure describing the FINRA BrokerCheck program will be furnished upon written request.

Free Credit Balances: Any customer free credit balances may be used in the business of WFS subject to limitations imposed by Rule 15c3-3 under the Securities Exchange Act of 1934. On demand, a customer has the right to receive delivery of the following: any free credit balances to which he or she is entitled, any fully paid securities to which he or she is entitled, and any securities purchased on margin upon full payment of indebtedness to WFS.

Equity Order Routing: WFS customers may request additional order routing information with respect to SEC Rule 606 by contacting their WFS sales representative. There are two reports available to WFS customers under amended Rule 606: (i) the 606(b)(1) held on-demand customer report and (ii) the 606(b)(3) not held on-demand customer report in the six months prior to the request. These reports can be found at <https://www.wellsfargo.com/com/securities/regulatory>

Equity Extended Hours Trading: See important information relating to equities trading before and after regular trading hours at: www.wellsfargo.com/com/securities/regulatory.

Equity Open Orders: Open orders will remain in effect until executed or canceled by you. Failure to cancel an open order may result in the transaction being executed for your account. WFS has no responsibility to cancel an open order at its own initiative.

Dividend Reinvestment: In any dividend reinvestment transaction, WFS acted as agent. Additional information regarding transactions of this nature will be furnished to a customer upon written request.

Account Transfers: A fee will be charged to customers transferring their existing WFS account to another broker/dealer or any other financial institution.

Non-deposit investment products recommended, offered or sold by WFS, including mutual funds, are not federally insured or guaranteed by or obligations of the Federal Deposit Insurance Corporation ("FDIC"), the Federal Reserve System or any other agency; are not bank deposits; are not obligations of, or endorsed or guaranteed in any way by any bank or WFS; and are subject to risk, including the possible loss of principal, that may cause the value of the investment and investment return to fluctuate.

When the investment is sold, the value may be higher or lower than the amount originally invested. WFS is a subsidiary of Wells Fargo & Company, is not a bank or thrift, and is separate from any other affiliated bank or thrift. WFS is a registered broker-dealer and member of FINRA. No affiliate of WFS is responsible for the securities sold by WFS.

Trade Confirmations: Investment purchases and sales are subject to the terms and conditions stated on the trade confirmation relating to that transaction. In the event of a conflict between the trade confirmation and this statement, the trade confirmation will govern.

Listed Options: Commissions and other charges related to the execution of listed option transactions have been included in confirmations of such transactions that have been previously furnished and are available upon request. Promptly advise your WFS sales representative of any material change in your investment objectives or financial situation.

Financial Statements: WFS financial statements are available upon request.

Customer Complaints and Reporting Discrepancies: Customer complaints, statement reporting inaccuracies or discrepancies should be promptly reported in writing to:

Customer Service
90 South 7th Street
5th Floor, MAC N9305-05F
Minneapolis, MN 55402
wfscustomerservice@wellsfargo.com

In the event your account is introduced to WFS by an affiliated broker-dealer as indicated on page 1 of your statement, you should also send a copy of your written correspondence to that introducing broker-dealer at the address appearing on that page.

Customers may also report complaints, inaccuracies or discrepancies by calling 1-800-645-3751 option 5. To further protect their rights, including rights under the Securities Investor Protection Act, customers should also re-confirm in writing to the above address any oral communications with WFS relating to the inaccuracies or discrepancies.

Mutual Funds: Institutional Prime and Institutional Tax Exempt money market mutual funds are required to price and transact at a net asset value ("NAV") per share that fluctuates based upon the pricing of the underlying portfolio of securities and this requirement may impact the value of those fund shares. Additionally, Institutional Prime and Institutional Tax-Exempt funds may be subject to redemption fees and/or gates that can affect the availability of funds invested.

Mutual funds are sold by prospectus, which includes more complete information on risks, charges, expenses and other matters of interest. Investors should read the prospectus carefully before investing.

Muni Substitute Interest: With respect to transactions involving your purchase of a municipal security having interest that is exempt from federal and/or state income taxes, if you do not receive good delivery of such securities on settlement date (i.e., all requirements for transferring title from the seller to the buyer have occurred), the interest that you accrue from the settlement date of the transaction until you receive good delivery may be considered by the Internal Revenue Service ("IRS") to be taxable ("substitute") interest. If you sell such securities before receiving good delivery, the IRS may consider all of the interest that you accrue to be taxable. You should consult with your tax advisors regarding the tax implication of any such fail to receive scenario.



Wells Fargo Bank, N.A.
 45 FREMONT ST
 FLOOR 34
 SAN FRANCISCO, CA 94105-2204

WILLIAMS/LEWIS
 1-415-644-9152

Bank Account Statement Wells Fargo Bank, N.A.

Statement Period
01/01/2024 - 01/31/2024

SAN LORENZO VALLEY WATER DISTRICT
 13060 HIGHWAY 9

Account Number
 1BD06974

Account Value Summary *USD*

This summary does not reflect the value of unpriced securities. Repurchase agreements are reflected at par value.

	Amount Last Statement Period	Amount This Statement Period	% Portfolio
Cash	\$ 0.00	\$ 0.00	0%
Money Market Mutual Funds	5,888,762.33	3,089,292.06	54%
Bonds	2,622,895.52	2,629,370.31	46%
Stocks	0.00	0.00	0%
Total Account Value	\$ 8,511,657.85	\$ 5,718,662.37	100%
Value Change Since Last Statement Period		\$ (2,792,995.48)	
Percent Decrease Since Last Statement Period		33%	
Value Last Year-End		\$ 8,511,657.85	
Percent Decrease Since Last Year-End		33%	

Income Summary *USD*

	This Period	Year-To-Date
Interest	\$ 7,501.25	\$ 7,501.25
Dividends/Capital Gains	0.00	0.00
Money Market Mutual Funds Dividends	25,804.45	25,804.45
Other	0.00	0.00
Income Total	\$ 33,305.70	\$ 33,305.70

Interest Charged *USD*

Description	This Period
Debit Interest For January 2024	0.00
Total Interest Charged	\$ 0.00

Money Market Mutual Funds Summary *USD*

Description	Amount
Opening Balance	\$ 5,888,762.33
Deposits and Other Additions	7,501.25
Distributions and Other Subtractions	(2,832,775.97)
Dividends Reinvested	25,804.45
Change in Value	0.00
Closing Balance	\$ 3,089,292.06

Important Information

This statement is provided to customers of Wells Fargo Bank, N.A. (the "Bank"). Statements are provided monthly for accounts with transactions and/or security positions.

Pricing: Security and other asset prices shown on the statement are obtained from independent vendors or internal pricing models. While we believe the prices are reliable, we cannot guarantee their accuracy. The prices indicated herein are as of the stated valuation date, which may not be the date of this statement, and are subject to change without notice. For exchange-listed securities, the price provided is the closing price of the relevant security at month end. For unlisted securities, it is the "bid" price of the relevant security at month end. The prices of instruments that trade infrequently are estimated using similar securities for which prices are available. Prices on the statement may not necessarily be obtained when the asset is sold.

Cash Balances: Cash held at the Bank is not covered by SIPC, but is instead eligible for FDIC insurance of up to \$250,000 per depositor, per institution, in accordance with FDIC rules.

Mutual Funds: You have the right, in the course of normal business operations, to withdraw balances in the Bank Deposit Sweep or redeem shares of the money market mutual fund used in the sweep, subject to any open commitments in any of your accounts and have the proceeds returned to your accounts or remitted to you. Note, however, that as required by federal banking regulations, the banks in the Bank Deposit Sweep reserve the right to require seven days prior notice before permitting a transfer out of the Bank Deposit Sweep. In addition, the money market mutual funds in the sweep reserve the right to require one or more day's prior notice before permitting withdrawals.

The Bank makes certain money market mutual funds available through the Bank Deposit Sweep and has

entered into agreements with the mutual fund companies with respect to the available funds. Mutual funds are sold by prospectus only. Please read the prospectus for further information including sales charges, deferred sales charges, withdrawal charges and management or other fees.

Muni Substitute Interest: With respect to transactions involving your purchase of a municipal security having interest that is exempt from federal and/or state income taxes, if you do not receive good delivery of such securities on settlement date (i.e., all requirements for transferring title from the seller to the buyer have occurred), the interest that you accrue from the settlement date of the transaction until you receive good delivery may be considered by the Internal Revenue Service ("IRS") to be taxable ("substitute") interest. If you sell such securities before receiving good delivery, the IRS may consider all of the interest that you accrue to be taxable. You should consult with your tax advisors regarding the tax implication of any such fail to receive scenario.

Non-deposit investment products offered or sold by the Bank, including investments in mutual funds available through the Bank, are not federally insured or guaranteed by or obligations of the U.S. government, the Federal Deposit Insurance Corporation ("FDIC"), the Federal Reserve System or any other government agency; are not bank deposits; are not obligations of, or endorsed or guaranteed in any way by any bank or the Bank; and are subject to risk, including the possible loss of principal, that may cause the value of the investment and the investment return to fluctuate. When the investment is sold, the amount may be higher or lower than the amount originally invested.

Customer Complaints and Reporting Discrepancies: All inquiries, statement reporting inaccuracies or discrepancies, or complaints regarding your account or the activity therein should be directed to:

Customer Service
90 South 7th Street
5th Floor, MAC N9303-054
Minneapolis, MN 55402
1-800-645-3751, option 5,
WFSCustomerService@Wellsfargo.com.

To further protect their rights, customers should also re-confirm in writing to the above address any oral communications with the Bank relating to inaccuracies or discrepancies.

The Bank's financial statements are available upon request.

Statement Ending: January 31, 2024

SAN LORENZO VALLEY WATER DISTRICT

Account Number: 1BD06974

Portfolio Holdings *Security positions held with Wells Fargo Bank N.A.*

Security ID	Description	Maturity Date	Coupon	Current Par / Original Par	Market Price*	Market Value	Original Par Pledged**	Callable
Bonds USD								
91282CEG2	UNITED STATES TREASURY NOTE	03/31/24	2.250%	1,645,000.000	99.5039	1,636,839.25		
91282CCG4	UNITED STATES TREASURY NOTE	06/15/24	0.250%	653,000.000	98.1992	641,240.90		
91282CGD7	UNITED STATES TREASURY NOTE	12/31/24	4.250%	353,000.000	99.5156	351,290.16		
				2,651,000.000		2,629,370.31	0.00	

*See important information regarding security pricing on Page 2.

**Total amount that is pledged to or held for another party or parties. Refer to the Pledge Detail Report for more information.

Daily Account Activity

Your investment transactions during this statement period.

Transaction / Trade Date	Settlement / Effective Date	Activity	Security ID	Description	Par / Quantity	Price	Principal Amount	Income Amount	Debit / Credit Amount
--------------------------	-----------------------------	----------	-------------	-------------	----------------	-------	------------------	---------------	-----------------------

Income / Payment Activity USD

01/02/24	01/02/24	Interest	91282CGD7	UNITED STATES TREASURY NOTE				7,501.25	7,501.25
----------	----------	----------	-----------	-----------------------------	--	--	--	----------	----------

Cash Activity USD

Transaction / Trade Date	Settlement / Eff. Date	Activity	Description	Debit Amount / Disbursements	Credit Amount / Receipts
01/18/24	01/18/24	ACH/DDA Transaction	DESIGNATED DDA	995,327.24	
01/23/24	01/23/24	ACH/DDA Transaction	DESIGNATED DDA	1,724,093.13	
01/30/24	01/30/24	ACH/DDA Transaction	DESIGNATED DDA	113,355.60	

Money Market Fund Activity

JPMorgan 100%UST Ins 199

*As of January 31, 2024

USD	Dividend paid this period	7 day* simple yield	30 day* simple yield
	25,804.45	5.170%	5.170%

Transaction Date	Activity	Shares	Price	Market Value (\$)	Dividend Amount	Share Balance
Beginning Balance			1.0000	5,888,762.33		5,888,762.33000
01/02/24	Reinvest	25,804.45000			25,804.45	5,914,566.78000
01/03/24	Purchase	7,501.25000		7,501.25		5,922,068.03000

SAN LORENZO VALLEY WATER DISTRICT
 Account Number: 1BD06974

Statement Ending: January 31, 2024

Money Market Fund Activity (Continued)

Transaction Date	Activity	Shares	Price	Market Value (\$)	Dividend Amount	Share Balance
01/18/24	Redemption	(995,327.24000)		(995,327.24)		4,926,740.79000
01/23/24	Redemption	(1,724,093.13000)		(1,724,093.13)		3,202,647.66000
01/30/24	Redemption	(113,355.60000)		(113,355.60)		3,089,292.06000
	Ending Balance		1.0000	3,089,292.06		3,089,292.06000



Wells Fargo Bank, N.A.
PO BOX 5120
SIOUX FALLS, SD 57117-5120
1-800-645-3751

Agenda: 4.4.24
Item: 12.3

BR STMT SAN LORENZO VALLEY WATER DISTRICT
13060 HIGHWAY 9
BOULDER CREEK, CA 95005



Enclosed is your Wells Fargo Bank, N.A. account statement. If you have elected Wells Fargo Bank, N.A. (WFB) as the safekeeping agent for your securities, then also enclosed is 1) a separate WFB safekeeping statement and 2) a page summarizing activity and investments in your WFBNA account and its related WFB account.

If you have multiple WFBNA accounts and have requested "house-holding," we have included the statements that pertain to those accounts in this single envelope.

Investments, other than Brokered Certificates of Deposits, are not FDIC insured, may lose value, and are not bank guaranteed - see important disclosures on the reverse of your account summary page.



Wells Fargo Bank, N.A.
45 FREMONT ST
FLOOR 34
SAN FRANCISCO, CA 94105-2204

WILLIAMS/LEWIS
1-415-644-9152

Combined Summary Brokerage Account and Bank Account

Statement Period
11/01/2023 - 11/30/2023

SAN LORENZO VALLEY WATER DISTRICT
13060 HIGHWAY 9
Account Number
1BD06974

Total Account Value Summary - US Dollar (USD)

This summary does not reflect the value of unpriced securities. Repurchase agreements are reflected at par value.

	Amount Last Statement Period	Amount This Statement Period	% Portfolio
Cash	\$ 0.00	\$ 0.00	0%
Money Market Mutual Funds	7,961,377.83	5,799,932.92	68%
Bonds	2,657,863.88	2,667,527.89	32%
Stocks	0.00	0.00	0%
Total Account Value	\$ 10,619,241.71	\$ 8,467,460.81	100%
Value Change Since Last Statement Period		\$ (2,151,780.90)	
Percent Decrease Since Last Statement Period		20%	
Value Last Year-End		\$ N/A	
Percent Increase Since Last Year-End		N/A	

***Includes amortized Par value of municipal leases and notes.

Total Income Summary USD

	This Period	Year-To-Date
Interest	\$ 0.00	\$ 45,330.00
Dividends/Capital Gains	0.00	0.00
Money Market Mutual Funds Dividends	36,494.34	155,672.13
Other	0.00	0.00
Income Total	\$ 36,494.34	\$ 201,002.13

Total Interest Charged USD

Description	This Period
Debit Interest For November 2023	0.00
Total Interest Charged	\$ 0.00

Total Money Market Mutual Funds Summary USD

Description	Amount
Opening Balance	\$ 7,961,377.83
Deposits and Other Additions	0.00
Distributions and Other Subtractions	(2,197,939.25)
Dividends Reinvested	36,494.34
Change in Value	0.00
Closing Balance	\$ 5,799,932.92



Wells Fargo Securities, LLC
 45 FREMONT ST
 FLOOR 34
 SAN FRANCISCO, CA 94105-2204

WILLIAMS/LEWIS
 1-415-644-9152

Brokerage Account Statement Wells Fargo Securities, LLC

Statement Period
11/01/2023 - 11/30/2023

SAN LORENZO VALLEY WATER DISTRICT
 13060 HIGHWAY 9

Account Number
 1BD06974

Account Value Summary *USD*

This summary does not reflect the value of unpriced securities. Repurchase agreements are reflected at par value.

	Amount Last Statement Period	Amount This Statement Period	% Portfolio
Cash	\$ 0.00	\$ 0.00	0%
Money Market Mutual Funds	0.00	0.00	0%
Bonds	0.00	0.00	0%
Stocks	0.00	0.00	0%
Total Account Value	\$ 0.00	\$ 0.00	0%
Value Change Since Last Statement Period		\$ 0.00	
Percent Increase Since Last Statement Period			N/A
Value Last Year-End		\$ N/A	
Percent Increase Since Last Year-End			N/A

Income Summary *USD*

	This Period	Year-To-Date
Interest	\$ 0.00	\$ 0.00
Dividends/Capital Gains	0.00	0.00
Money Market Mutual Funds Dividends	0.00	0.00
Other	0.00	0.00
Income Total	\$ 0.00	\$ 0.00

Interest Charged *USD*

Description	This Period
Debit Interest For November 2023	0.00
Total Interest Charged	\$ 0.00

Money Market Mutual Funds Summary *USD*

Description	Amount
Opening Balance	\$ 0.00
Deposits and Other Additions	0.00
Distributions and Other Subtractions	0.00
Dividends Reinvested	0.00
Change in Value	0.00
Closing Balance	\$ 0.00

Important Information

This statement is provided to customers of Wells Fargo Securities, LLC ("WFS"), or customers of affiliated broker-dealers whose accounts are introduced to and carried by WFS. Statements are provided monthly for accounts with transactions and/or security positions. The account statement contains a list of securities held in custody by WFS as of the statement date and provides details of purchase and sale transactions, the receipt and disbursement of cash and securities, and other activities relating to the account during the statement period.

For WFS customers who choose to maintain a safekeeping account at Wells Fargo Bank, N.A. ("Bank"), this statement is accompanied by a separate Bank safekeeping statement. The Bank safekeeping statement, if applicable, contains a list of securities held in safekeeping by the Bank as of the statement date.

Pricing: Security and other asset prices shown on the statement are obtained from independent vendors or internal pricing models. While we believe the prices are reliable, we cannot guarantee their accuracy. The prices indicated herein are as of the stated valuation date, which may not be the date of this statement, and are subject to change without notice. For exchange-listed securities, the price provided is the closing price at month end. For unlisted securities, it is the "bid" price at month end. The prices of CDs that mature in one year or less are shown at last price traded. The prices of CDs that mature in greater than one year and of other instruments that trade infrequently are estimated using similar securities for which prices are available. Prices on the statement may not necessarily be obtained when the asset is sold.

Brokered CD Pricing: Like bonds, brokered CDs are subject to price fluctuation and the value of a CD, if sold prior to maturity, may be less than at the time of its purchase. Significant loss of principal could result. While WFS generally makes a market in CDs it underwrites, the secondary market for CDs that it does not underwrite may be very limited. In those cases, WFS will use its best efforts to help investors find a buyer.

SIPC: WFS is a member of the Securities Investor Protection Corporation ("SIPC"). In the event of insolvency or liquidation of WFS, securities held in safekeeping at WFS are covered by SIPC against the loss, but not investment risk, up to a maximum of \$500,000 per customer, which includes a \$250,000 limit on claims for cash held in the account. SIPC protection does not provide any protection whatsoever against investment risk, including the loss of principal on an investment. This coverage does not apply to securities held in safekeeping by the Bank. Additional information about SIPC, including a SIPC brochure, may be obtained by visiting www.sipc.org or by calling SIPC at 1-202-371-8300.

FINRA BrokerCheck Program: WFS is a member of the Financial Industry Regulatory Authority (FINRA). Under its BrokerCheck program, FINRA provides certain information regarding the disciplinary history of broker/dealers and their associated persons. Information can be obtained from the FINRA BrokerCheck program hotline number (1-800-289-9999) or the FINRA website (www.finra.org). A brochure describing the FINRA BrokerCheck program will be furnished upon written request.

Free Credit Balances: Any customer free credit balances may be used in the business of WFS subject to limitations imposed by Rule 15c3-3 under the Securities Exchange Act of 1934. On demand, a customer has the right to receive delivery of the following: any free credit balances to which he or she is entitled, any fully paid securities to which he or she is entitled, and any securities purchased on margin upon full payment of indebtedness to WFS.

Equity Order Routing: WFS customers may request additional order routing information with respect to SEC Rule 606 by contacting their WFS sales representative. There are two reports available to WFS customers under amended Rule 606: (i) the 606(b)(1) held on-demand customer report and (ii) the 606(b)(3) not held on-demand customer report in the six months prior to the request. These reports can be found at <https://www.wellsfargo.com/com/securities/regulatory>

Equity Extended Hours Trading: See important information relating to equities trading before and after regular trading hours at: www.wellsfargo.com/com/securities/regulatory.

Equity Open Orders: Open orders will remain in effect until executed or canceled by you. Failure to cancel an open order may result in the transaction being executed for your account. WFS has no responsibility to cancel an open order at its own initiative.

Dividend Reinvestment: In any dividend reinvestment transaction, WFS acted as agent. Additional information regarding transactions of this nature will be furnished to a customer upon written request.

Account Transfers: A fee will be charged to customers transferring their existing WFS account to another broker/dealer or any other financial institution.

Non-deposit investment products recommended, offered or sold by WFS, including mutual funds, are not federally insured or guaranteed by or obligations of the Federal Deposit Insurance Corporation ("FDIC"), the Federal Reserve System or any other agency; are not bank deposits; are not obligations of, or endorsed or guaranteed in any way by any bank or WFS; and are subject to risk, including the possible loss of principal, that may cause the value of the investment and investment return to fluctuate.

When the investment is sold, the value may be higher or lower than the amount originally invested. WFS is a subsidiary of Wells Fargo & Company, is not a bank or thrift, and is separate from any other affiliated bank or thrift. WFS is a registered broker-dealer and member of FINRA. No affiliate of WFS is responsible for the securities sold by WFS.

Trade Confirmations: Investment purchases and sales are subject to the terms and conditions stated on the trade confirmation relating to that transaction. In the event of a conflict between the trade confirmation and this statement, the trade confirmation will govern.

Listed Options: Commissions and other charges related to the execution of listed option transactions have been included in confirmations of such transactions that have been previously furnished and are available upon request. Promptly advise your WFS sales representative of any material change in your investment objectives or financial situation.

Financial Statements: WFS financial statements are available upon request.

Customer Complaints and Reporting Discrepancies: Customer complaints, statement reporting inaccuracies or discrepancies should be promptly reported in writing to:

Customer Service
90 South 7th Street
5th Floor, MAC N9305-05F
Minneapolis, MN 55402
wfscustomerservice@wellsfargo.com

In the event your account is introduced to WFS by an affiliated broker-dealer as indicated on page 1 of your statement, you should also send a copy of your written correspondence to that introducing broker-dealer at the address appearing on that page.

Customers may also report complaints, inaccuracies or discrepancies by calling 1-800-645-3751 option 5. To further protect their rights, including rights under the Securities Investor Protection Act, customers should also re-confirm in writing to the above address any oral communications with WFS relating to the inaccuracies or discrepancies.

Mutual Funds: Institutional Prime and Institutional Tax Exempt money market mutual funds are required to price and transact at a net asset value ("NAV") per share that fluctuates based upon the pricing of the underlying portfolio of securities and this requirement may impact the value of those fund shares. Additionally, Institutional Prime and Institutional Tax-Exempt funds may be subject to redemption fees and/or gates that can affect the availability of funds invested.

Mutual funds are sold by prospectus, which includes more complete information on risks, charges, expenses and other matters of interest. Investors should read the prospectus carefully before investing.

Muni Substitute Interest: With respect to transactions involving your purchase of a municipal security having interest that is exempt from federal and/or state income taxes, if you do not receive good delivery of such securities on settlement date (i.e., all requirements for transferring title from the seller to the buyer have occurred), the interest that you accrue from the settlement date of the transaction until you receive good delivery may be considered by the Internal Revenue Service ("IRS") to be taxable ("substitute") interest. If you sell such securities before receiving good delivery, the IRS may consider all of the interest that you accrue to be taxable. You should consult with your tax advisors regarding the tax implication of any such fail to receive scenario.



Wells Fargo Bank, N.A.
 45 FREMONT ST
 FLOOR 34
 SAN FRANCISCO, CA 94105-2204

WILLIAMS/LEWIS
 1-415-644-9152

Bank Account Statement
Wells Fargo Bank, N.A.

Statement Period
11/01/2023 - 11/30/2023

SAN LORENZO VALLEY WATER DISTRICT
 13060 HIGHWAY 9

Account Number
 1BD06974

Account Value Summary USD

This summary does not reflect the value of unpriced securities. Repurchase agreements are reflected at par value.

	Amount Last Statement Period	Amount This Statement Period	% Portfolio
Cash	\$ 0.00	\$ 0.00	0%
Money Market Mutual Funds	7,961,377.83	5,799,932.92	68%
Bonds	2,657,863.88	2,667,527.89	32%
Stocks	0.00	0.00	0%
Total Account Value	\$ 10,619,241.71	\$ 8,467,460.81	100%
Value Change Since Last Statement Period		\$ (2,151,780.90)	
Percent Decrease Since Last Statement Period		20%	
Value Last Year-End		\$ N/A	
Percent Increase Since Last Year-End		N/A	

Income Summary USD

	This Period	Year-To-Date
Interest	\$ 0.00	\$ 45,330.00
Dividends/Capital Gains	0.00	0.00
Money Market Mutual Funds Dividends	36,494.34	155,672.13
Other	0.00	0.00
Income Total	\$ 36,494.34	\$ 201,002.13

Interest Charged USD

Description	This Period
Debit Interest For November 2023	0.00
Total Interest Charged	\$ 0.00

Money Market Mutual Funds Summary USD

Description	Amount
Opening Balance	\$ 7,961,377.83
Deposits and Other Additions	0.00
Distributions and Other Subtractions	(2,197,939.25)
Dividends Reinvested	36,494.34
Change in Value	0.00
Closing Balance	\$ 5,799,932.92

Important Information

This statement is provided to customers of Wells Fargo Bank, N.A. (the "Bank"). Statements are provided monthly for accounts with transactions and/or security positions.

Pricing: Security and other asset prices shown on the statement are obtained from independent vendors or internal pricing models. While we believe the prices are reliable, we cannot guarantee their accuracy. The prices indicated herein are as of the stated valuation date, which may not be the date of this statement, and are subject to change without notice. For exchange-listed securities, the price provided is the closing price of the relevant security at month end. For unlisted securities, it is the "bid" price of the relevant security at month end. The prices of instruments that trade infrequently are estimated using similar securities for which prices are available. Prices on the statement may not necessarily be obtained when the asset is sold.

Cash Balances: Cash held at the Bank is not covered by SIPC, but is instead eligible for FDIC insurance of up to \$250,000 per depositor, per institution, in accordance with FDIC rules.

Mutual Funds: You have the right, in the course of normal business operations, to withdraw balances in the Bank Deposit Sweep or redeem shares of the money market mutual fund used in the sweep, subject to any open commitments in any of your accounts and have the proceeds returned to your accounts or remitted to you. Note, however, that as required by federal banking regulations, the banks in the Bank Deposit Sweep reserve the right to require seven days prior notice before permitting a transfer out of the Bank Deposit Sweep. In addition, the money market mutual funds in the sweep reserve the right to require one or more day's prior notice before permitting withdrawals. The Bank makes certain money market mutual funds available through the Bank Deposit Sweep and has

entered into agreements with the mutual fund companies with respect to the available funds. Mutual funds are sold by prospectus only. Please read the prospectus for further information including sales charges, deferred sales charges, withdrawal charges and management or other fees.

Muni Substitute Interest: With respect to transactions involving your purchase of a municipal security having interest that is exempt from federal and/or state income taxes, if you do not receive good delivery of such securities on settlement date (i.e., all requirements for transferring title from the seller to the buyer have occurred), the interest that you accrue from the settlement date of the transaction until you receive good delivery may be considered by the Internal Revenue Service ("IRS") to be taxable ("substitute") interest. If you sell such securities before receiving good delivery, the IRS may consider all of the interest that you accrue to be taxable. You should consult with your tax advisors regarding the tax implication of any such fail to receive scenario.

Non-deposit investment products offered or sold by the Bank, including investments in mutual funds available through the Bank, are not federally insured or guaranteed by or obligations of the U.S. government, the Federal Deposit Insurance Corporation ("FDIC"), the Federal Reserve System or any other government agency; are not bank deposits; are not obligations of, or endorsed or guaranteed in any way by any bank or the Bank; and are subject to risk, including the possible loss of principal, that may cause the value of the investment and the investment return to fluctuate. When the investment is sold, the amount may be higher or lower than the amount originally invested.

Customer Complaints and Reporting Discrepancies: All inquiries, statement reporting inaccuracies or discrepancies, or complaints regarding your account or the activity therein should be directed to:
Customer Service
90 South 7th Street
5th Floor, MAC N9303-054
Minneapolis, MN 55402
1-800-645-3751, option 5,
WFSCustomerService@Wellsfargo.com.
To further protect their rights, customers should also re-confirm in writing to the above address any oral communications with the Bank relating to inaccuracies or discrepancies.

The Bank's financial statements are available upon request.

Statement Ending: November 30, 2023

SAN LORENZO VALLEY WATER DISTRICT

Account Number: 1BD06974

Portfolio Holdings *Security positions held with Wells Fargo Bank N.A.*

Security ID	Description	Maturity Date	Coupon	Current Par / Original Par	Market Price*	Market Value	Original Par Pledged**	Callable
Bonds USD								
912796ZN2	UNITED STATES TREASURY BILL	12/28/23	0.000%	54,000.000	99.6040	53,786.19		
91282CEG2	UNITED STATES TREASURY NOTE	03/31/24	2.250%	1,645,000.000	98.9941	1,628,453.62		
91282CCG4	UNITED STATES TREASURY NOTE	06/15/24	0.250%	653,000.000	97.3477	635,680.19		
91282CGD7	UNITED STATES TREASURY NOTE	12/31/24	4.250%	353,000.000	99.0391	349,607.89		
				2,705,000.000		2,667,527.89	0.00	

*See important information regarding security pricing on Page 2.

**Total amount that is pledged to or held for another party or parties. Refer to the Pledge Detail Report for more information.

Daily Account Activity

Your investment transactions during this statement period.

Cash Activity USD

Transaction / Trade Date	Settlement / Eff. Date	Activity	Description	Debit Amount / Disbursements	Credit Amount / Receipts
11/30/23	11/30/23	ACH/DDA Transaction	DESIGNATED DDA	2,197,939.25	

Money Market Fund Activity

JPMorgan 100%UST Ins 199

*As of November 30, 2023

			Dividend paid this period	7 day* simple yield	30 day* simple yield
USD			36,494.34	5.230%	5.220%

Transaction Date	Activity	Shares	Price	Market Value (\$)	Dividend Amount	Share Balance
Beginning Balance			1.0000	7,961,377.83		7,961,377.83000
11/01/23	Reinvest	36,494.34000			36,494.34	7,997,872.17000
11/30/23	Redemption	(2,197,939.25000)		(2,197,939.25)		5,799,932.92000
Ending Balance			1.0000	5,799,932.92		5,799,932.92000



Wells Fargo Bank, N.A.
PO BOX 5120
SIOUX FALLS, SD 57117-5120
1-800-645-3751

Agenda: 4.4.24
Item: 12.3

BR STMT SAN LORENZO VALLEY WATER DISTRICT
13060 HIGHWAY 9
BOULDER CREEK, CA 95005



Enclosed is your Wells Fargo Bank, N.A. account statement. If you have elected Wells Fargo Bank, N.A. (WFB) as the safekeeping agent for your securities, then also enclosed is 1) a separate WFB safekeeping statement and 2) a page summarizing activity and investments in your WFBNA account and its related WFB account.

If you have multiple WFBNA accounts and have requested "house-holding," we have included the statements that pertain to those accounts in this single envelope.

Investments, other than Brokered Certificates of Deposits, are not FDIC insured, may lose value, and are not bank guaranteed - see important disclosures on the reverse of your account summary page.



Wells Fargo Bank, N.A.
45 FREMONT ST
FLOOR 34
SAN FRANCISCO, CA 94105-2204

WILLIAMS/LEWIS
1-415-644-9152

Combined Summary Brokerage Account and Bank Account

Statement Period
12/01/2023 - 12/31/2023

SAN LORENZO VALLEY WATER DISTRICT
13060 HIGHWAY 9
Account Number
1BD06974

Total Account Value Summary - US Dollar (USD)

This summary does not reflect the value of unpriced securities. Repurchase agreements are reflected at par value.

	Amount Last Statement Period	Amount This Statement Period	% Portfolio
Cash	\$ 0.00	\$ 0.00	0%
Money Market Mutual Funds	5,799,932.92	5,888,762.33	69%
Bonds	2,667,527.89	2,622,895.52	31%
Stocks	0.00	0.00	0%
Total Account Value	\$ 8,467,460.81	\$ 8,511,657.85	100%

Value Change Since Last Statement Period \$ **44,197.04**

Percent Increase Since Last Statement Period **1%**

Value Last Year-End \$ **N/A**

Percent Increase Since Last Year-End **N/A**

***Includes amortized Par value of municipal leases and notes.

Total Income Summary USD

	This Period	Year-To-Date
Interest	\$ 816.25	\$ 46,146.25
Dividends/Capital Gains	0.00	0.00
Money Market Mutual Funds Dividends	34,013.16	189,685.29
Other	0.00	0.00
Income Total	\$ 34,829.41	\$ 235,831.54

Total Interest Charged USD

Description	This Period
Debit Interest For December 2023	0.00
Total Interest Charged	\$ 0.00

Total Money Market Mutual Funds Summary USD

Description	Amount
Opening Balance	\$ 5,799,932.92
Deposits and Other Additions	54,816.25
Distributions and Other Subtractions	0.00
Dividends Reinvested	34,013.16
Change in Value	0.00
Closing Balance	\$ 5,888,762.33



Wells Fargo Securities, LLC
 45 FREMONT ST
 FLOOR 34
 SAN FRANCISCO, CA 94105-2204

WILLIAMS/LEWIS
 1-415-644-9152

Brokerage Account Statement Wells Fargo Securities, LLC

Statement Period
12/01/2023 - 12/31/2023

SAN LORENZO VALLEY WATER DISTRICT
 13060 HIGHWAY 9

Account Number
 1BD06974

Account Value Summary *USD*

This summary does not reflect the value of unpriced securities. Repurchase agreements are reflected at par value.

	Amount Last Statement Period	Amount This Statement Period	% Portfolio
Cash	\$ 0.00	\$ 0.00	0%
Money Market Mutual Funds	0.00	0.00	0%
Bonds	0.00	0.00	0%
Stocks	0.00	0.00	0%
Total Account Value	\$ 0.00	\$ 0.00	0%
Value Change Since Last Statement Period		\$ 0.00	
Percent Increase Since Last Statement Period			N/A
Value Last Year-End		\$ N/A	
Percent Increase Since Last Year-End			N/A

Income Summary *USD*

	This Period	Year-To-Date
Interest	\$ 0.00	\$ 0.00
Dividends/Capital Gains	0.00	0.00
Money Market Mutual Funds Dividends	0.00	0.00
Other	0.00	0.00
Income Total	\$ 0.00	\$ 0.00

Interest Charged *USD*

Description	This Period
Debit Interest For December 2023	0.00
Total Interest Charged	\$ 0.00

Money Market Mutual Funds Summary *USD*

Description	Amount
Opening Balance	\$ 0.00
Deposits and Other Additions	0.00
Distributions and Other Subtractions	0.00
Dividends Reinvested	0.00
Change in Value	0.00
Closing Balance	\$ 0.00

Important Information

This statement is provided to customers of Wells Fargo Securities, LLC ("WFS"), or customers of affiliated broker-dealers whose accounts are introduced to and carried by WFS. Statements are provided monthly for accounts with transactions and/or security positions. The account statement contains a list of securities held in custody by WFS as of the statement date and provides details of purchase and sale transactions, the receipt and disbursement of cash and securities, and other activities relating to the account during the statement period.

For WFS customers who choose to maintain a safekeeping account at Wells Fargo Bank, N.A. ("Bank"), this statement is accompanied by a separate Bank safekeeping statement. The Bank safekeeping statement, if applicable, contains a list of securities held in safekeeping by the Bank as of the statement date.

Pricing: Security and other asset prices shown on the statement are obtained from independent vendors or internal pricing models. While we believe the prices are reliable, we cannot guarantee their accuracy. The prices indicated herein are as of the stated valuation date, which may not be the date of this statement, and are subject to change without notice. For exchange-listed securities, the price provided is the closing price at month end. For unlisted securities, it is the "bid" price at month end. The prices of CDs that mature in one year or less are shown at last price traded. The prices of CDs that mature in greater than one year and of other instruments that trade infrequently are estimated using similar securities for which prices are available. Prices on the statement may not necessarily be obtained when the asset is sold.

Brokered CD Pricing: Like bonds, brokered CDs are subject to price fluctuation and the value of a CD, if sold prior to maturity, may be less than at the time of its purchase. Significant loss of principal could result. While WFS generally makes a market in CDs it underwrites, the secondary market for CDs that it does not underwrite may be very limited. In those cases, WFS will use its best efforts to help investors find a buyer.

SIPC: WFS is a member of the Securities Investor Protection Corporation ("SIPC"). In the event of insolvency or liquidation of WFS, securities held in safekeeping at WFS are covered by SIPC against the loss, but not investment risk, up to a maximum of \$500,000 per customer, which includes a \$250,000 limit on claims for cash held in the account. SIPC protection does not provide any protection whatsoever against investment risk, including the loss of principal on an investment. This coverage does not apply to securities held in safekeeping by the Bank. Additional information about SIPC, including a SIPC brochure, may be obtained by visiting www.sipc.org or by calling SIPC at 1-202-371-8300.

FINRA BrokerCheck Program: WFS is a member of the Financial Industry Regulatory Authority (FINRA). Under its BrokerCheck program, FINRA provides certain information regarding the disciplinary history of broker/dealers and their associated persons. Information can be obtained from the FINRA BrokerCheck program hotline number (1-800-289-9999) or the FINRA website (www.finra.org). A brochure describing the FINRA BrokerCheck program will be furnished upon written request.

Free Credit Balances: Any customer free credit balances may be used in the business of WFS subject to limitations imposed by Rule 15c3-3 under the Securities Exchange Act of 1934. On demand, a customer has the right to receive delivery of the following: any free credit balances to which he or she is entitled, any fully paid securities to which he or she is entitled, and any securities purchased on margin upon full payment of indebtedness to WFS.

Equity Order Routing: WFS customers may request additional order routing information with respect to SEC Rule 606 by contacting their WFS sales representative. There are two reports available to WFS customers under amended Rule 606: (i) the 606(b)(1) held on-demand customer report and (ii) the 606(b)(3) not held on-demand customer report in the six months prior to the request. These reports can be found at <https://www.wellsfargo.com/com/securities/regulatory>

Equity Extended Hours Trading: See important information relating to equities trading before and after regular trading hours at: www.wellsfargo.com/com/securities/regulatory.

Equity Open Orders: Open orders will remain in effect until executed or canceled by you. Failure to cancel an open order may result in the transaction being executed for your account. WFS has no responsibility to cancel an open order at its own initiative.

Dividend Reinvestment: In any dividend reinvestment transaction, WFS acted as agent. Additional information regarding transactions of this nature will be furnished to a customer upon written request.

Account Transfers: A fee will be charged to customers transferring their existing WFS account to another broker/dealer or any other financial institution.

Non-deposit investment products recommended, offered or sold by WFS, including mutual funds, are not federally insured or guaranteed by or obligations of the Federal Deposit Insurance Corporation ("FDIC"), the Federal Reserve System or any other agency; are not bank deposits; are not obligations of, or endorsed or guaranteed in any way by any bank or WFS; and are subject to risk, including the possible loss of principal, that may cause the value of the investment and investment return to fluctuate.

When the investment is sold, the value may be higher or lower than the amount originally invested. WFS is a subsidiary of Wells Fargo & Company, is not a bank or thrift, and is separate from any other affiliated bank or thrift. WFS is a registered broker-dealer and member of FINRA. No affiliate of WFS is responsible for the securities sold by WFS.

Trade Confirmations: Investment purchases and sales are subject to the terms and conditions stated on the trade confirmation relating to that transaction. In the event of a conflict between the trade confirmation and this statement, the trade confirmation will govern.

Listed Options: Commissions and other charges related to the execution of listed option transactions have been included in confirmations of such transactions that have been previously furnished and are available upon request. Promptly advise your WFS sales representative of any material change in your investment objectives or financial situation.

Financial Statements: WFS financial statements are available upon request.

Customer Complaints and Reporting Discrepancies: Customer complaints, statement reporting inaccuracies or discrepancies should be promptly reported in writing to:

Customer Service
90 South 7th Street
5th Floor, MAC N9305-05F
Minneapolis, MN 55402
wfscustomerservice@wellsfargo.com

In the event your account is introduced to WFS by an affiliated broker-dealer as indicated on page 1 of your statement, you should also send a copy of your written correspondence to that introducing broker-dealer at the address appearing on that page.

Customers may also report complaints, inaccuracies or discrepancies by calling 1-800-645-3751 option 5. To further protect their rights, including rights under the Securities Investor Protection Act, customers should also re-confirm in writing to the above address any oral communications with WFS relating to the inaccuracies or discrepancies.

Mutual Funds: Institutional Prime and Institutional Tax Exempt money market mutual funds are required to price and transact at a net asset value ("NAV") per share that fluctuates based upon the pricing of the underlying portfolio of securities and this requirement may impact the value of those fund shares. Additionally, Institutional Prime and Institutional Tax-Exempt funds may be subject to redemption fees and/or gates that can affect the availability of funds invested.

Mutual funds are sold by prospectus, which includes more complete information on risks, charges, expenses and other matters of interest. Investors should read the prospectus carefully before investing.

Muni Substitute Interest: With respect to transactions involving your purchase of a municipal security having interest that is exempt from federal and/or state income taxes, if you do not receive good delivery of such securities on settlement date (i.e., all requirements for transferring title from the seller to the buyer have occurred), the interest that you accrue from the settlement date of the transaction until you receive good delivery may be considered by the Internal Revenue Service ("IRS") to be taxable ("substitute") interest. If you sell such securities before receiving good delivery, the IRS may consider all of the interest that you accrue to be taxable. You should consult with your tax advisors regarding the tax implication of any such fail to receive scenario.



Wells Fargo Bank, N.A.
 45 FREMONT ST
 FLOOR 34
 SAN FRANCISCO, CA 94105-2204

WILLIAMS/LEWIS
 1-415-644-9152

Bank Account Statement Wells Fargo Bank, N.A.

Statement Period
12/01/2023 - 12/31/2023

SAN LORENZO VALLEY WATER DISTRICT
 13060 HIGHWAY 9

Account Number
 1BD06974

Account Value Summary *USD*

This summary does not reflect the value of unpriced securities. Repurchase agreements are reflected at par value.

	Amount Last Statement Period	Amount This Statement Period	% Portfolio
Cash	\$ 0.00	\$ 0.00	0%
Money Market Mutual Funds	5,799,932.92	5,888,762.33	69%
Bonds	2,667,527.89	2,622,895.52	31%
Stocks	0.00	0.00	0%
Total Account Value	\$ 8,467,460.81	\$ 8,511,657.85	100%
Value Change Since Last Statement Period		\$ 44,197.04	
Percent Increase Since Last Statement Period		1%	
Value Last Year-End		\$ N/A	
Percent Increase Since Last Year-End		N/A	

Income Summary *USD*

	This Period	Year-To-Date
Interest	\$ 816.25	\$ 46,146.25
Dividends/Capital Gains	0.00	0.00
Money Market Mutual Funds Dividends	34,013.16	189,685.29
Other	0.00	0.00
Income Total	\$ 34,829.41	\$ 235,831.54

Interest Charged *USD*

Description	This Period
Debit Interest For December 2023	0.00
Total Interest Charged	\$ 0.00

Money Market Mutual Funds Summary *USD*

Description	Amount
Opening Balance	\$ 5,799,932.92
Deposits and Other Additions	54,816.25
Distributions and Other Subtractions	0.00
Dividends Reinvested	34,013.16
Change in Value	0.00
Closing Balance	\$ 5,888,762.33

Important Information

This statement is provided to customers of Wells Fargo Bank, N.A. (the "Bank"). Statements are provided monthly for accounts with transactions and/or security positions.

Pricing: Security and other asset prices shown on the statement are obtained from independent vendors or internal pricing models. While we believe the prices are reliable, we cannot guarantee their accuracy. The prices indicated herein are as of the stated valuation date, which may not be the date of this statement, and are subject to change without notice. For exchange-listed securities, the price provided is the closing price of the relevant security at month end. For unlisted securities, it is the "bid" price of the relevant security at month end. The prices of instruments that trade infrequently are estimated using similar securities for which prices are available. Prices on the statement may not necessarily be obtained when the asset is sold.

Cash Balances: Cash held at the Bank is not covered by SIPC, but is instead eligible for FDIC insurance of up to \$250,000 per depositor, per institution, in accordance with FDIC rules.

Mutual Funds: You have the right, in the course of normal business operations, to withdraw balances in the Bank Deposit Sweep or redeem shares of the money market mutual fund used in the sweep, subject to any open commitments in any of your accounts and have the proceeds returned to your accounts or remitted to you. Note, however, that as required by federal banking regulations, the banks in the Bank Deposit Sweep reserve the right to require seven days prior notice before permitting a transfer out of the Bank Deposit Sweep. In addition, the money market mutual funds in the sweep reserve the right to require one or more day's prior notice before permitting withdrawals.

The Bank makes certain money market mutual funds available through the Bank Deposit Sweep and has

entered into agreements with the mutual fund companies with respect to the available funds. Mutual funds are sold by prospectus only. Please read the prospectus for further information including sales charges, deferred sales charges, withdrawal charges and management or other fees.

Muni Substitute Interest: With respect to transactions involving your purchase of a municipal security having interest that is exempt from federal and/or state income taxes, if you do not receive good delivery of such securities on settlement date (i.e., all requirements for transferring title from the seller to the buyer have occurred), the interest that you accrue from the settlement date of the transaction until you receive good delivery may be considered by the Internal Revenue Service ("IRS") to be taxable ("substitute") interest. If you sell such securities before receiving good delivery, the IRS may consider all of the interest that you accrue to be taxable. You should consult with your tax advisors regarding the tax implication of any such fail to receive scenario.

Non-deposit investment products offered or sold by the Bank, including investments in mutual funds available through the Bank, are not federally insured or guaranteed by or obligations of the U.S. government, the Federal Deposit Insurance Corporation ("FDIC"), the Federal Reserve System or any other government agency; are not bank deposits; are not obligations of, or endorsed or guaranteed in any way by any bank or the Bank; and are subject to risk, including the possible loss of principal, that may cause the value of the investment and the investment return to fluctuate. When the investment is sold, the amount may be higher or lower than the amount originally invested.

Customer Complaints and Reporting Discrepancies: All inquiries, statement reporting inaccuracies or discrepancies, or complaints regarding your account or the activity therein should be directed to:

Customer Service
90 South 7th Street
5th Floor, MAC N9303-054
Minneapolis, MN 55402
1-800-645-3751, option 5,
WFSCustomerService@Wellsfargo.com.

To further protect their rights, customers should also re-confirm in writing to the above address any oral communications with the Bank relating to inaccuracies or discrepancies.

The Bank's financial statements are available upon request.

Statement Ending: December 31, 2023

SAN LORENZO VALLEY WATER DISTRICT

Account Number: 1BD06974

Portfolio Holdings *Security positions held with Wells Fargo Bank N.A.*

Security ID	Description	Maturity Date	Coupon	Current Par / Original Par	Market Price*	Market Value	Original Par Pledged**	Callable
Bonds USD								
91282CEG2	UNITED STATES TREASURY NOTE	03/31/24	2.250%	1,645,000.000	99.2715	1,633,015.91		
91282CCG4	UNITED STATES TREASURY NOTE	06/15/24	0.250%	653,000.000	97.8164	638,741.13		
91282CGD7	UNITED STATES TREASURY NOTE	12/31/24	4.250%	353,000.000	99.4727	351,138.48		
				2,651,000.000		2,622,895.52	0.00	

*See important information regarding security pricing on Page 2.

**Total amount that is pledged to or held for another party or parties. Refer to the Pledge Detail Report for more information.

Daily Account Activity

Your investment transactions during this statement period.

Transaction / Trade Date	Settlement / Effective Date	Activity	Security ID	Description	Par / Quantity	Price	Principal Amount	Income Amount	Debit / Credit Amount
12/15/23	12/15/23	Interest	91282CCG4	UNITED STATES TREASURY NOTE				816.25	816.25
12/28/23	12/28/23	Matured	912796ZN2	UNITED STATES TREASURY BILL			54,000.00		54,000.00
12/28/23	12/28/23	Matured	912796ZN2	UNITED STATES TREASURY BILL	(54,000.00)				

Income / Payment Activity USD

Money Market Fund Activity

JPMorgan 100%UST Ins 199

*As of December 31, 2023

USD	Dividend paid this period	7 day* simple yield	30 day* simple yield
	34,013.16	5.200%	5.210%

Transaction Date	Activity	Shares	Price	Market Value (\$)	Dividend Amount	Share Balance
Beginning Balance			1.0000	5,799,932.92		5,799,932.92000
12/01/23	Reinvest	34,013.16000			34,013.16	5,833,946.08000
12/15/23	Purchase	816.25000		816.25		5,834,762.33000
12/29/23	Purchase	54,000.00000		54,000.00		5,888,762.33000
Ending Balance			1.0000	5,888,762.33		5,888,762.33000

Accounts Payable

Checks by Date - Detail by Check Date

User: RachelMunoz
Printed: 3/22/2024 9:42 AM



Check No	Vendor No Invoice No	Vendor Name Description	Check Date Reference	Void Checks	Check Amount
ACH	00313	MET LIFE	11/01/2023		
	101523_313A	DENTAL_ADMIN			199.82
	101523_313B	DISABILITY_ADMIN			86.12
	101523_313C	LIFE INS_ADMIN			21.64
	101523_313D	DENTAL_FINANCE			1,198.57
	101523_313E	DISABILITY_FINANCE			275.31
	101523_313F	LIFE INS_FINANCE			141.53
	101523_313G	DENTAL_ENG			399.64
	101523_313H	DISABILITY_ENG			184.92
	101523_313I	LIFE INS_ENG			66.60
	101523_313J	DENTAL_OPS			1,489.94
	101523_313K	DISABILITY_OPS			269.77
	101523_313L	LIFE INS_OPS			146.52
	101523_313M	DENTAL_ENVIRON			65.07
	101523_313N	DISABILITY_ENVIRON			32.40
	101523_313O	LIFE INS_ENVIRON			16.65
	101523_313P	DENTAL_WTP			1,192.59
	101523_313Q	DISABILITY_WTP			239.84
	101523_313R	LIFE INS_WTP			119.88
		Total for this ACH Check for Vendor 00313:		0.00	6,146.81
ACH	00399	VISION SERVICE PLAN - (CA)	11/01/2023		
	819053968A	VISION_ADMIN			28.44
	819053968B	VISION_FINANCE			177.78
	819053968C	VISION_ENG			56.88
	819053968D	VISION_OPS			214.20
	819053968E	VISION_WTP			171.96
		Total for this ACH Check for Vendor 00399:		0.00	649.26
ACH	00545	AFLAC	11/01/2023		
	583544	2023 INSURANCE PREMIUMS			189.63
		Total for this ACH Check for Vendor 00545:		0.00	189.63
ACH	10005	MISSIONSQUARE RETIREMENT	11/01/2023		
	6534234	PAY PERIOD ENDING 10/18/23			14,853.85
		Total for this ACH Check for Vendor 10005:		0.00	14,853.85
ACH	00178	CALPERS	11/01/2023		
	NOV2023A	CALPERS_ADMIN			2,956.31
	NOV2023B	CALPERS_FINANCE			16,000.07
	NOV2023C	CALPERS_ENGINEERING			5,901.94
	NOV2023D	CALPERS_OPS			22,520.79
	NOV2023E	CALPERS_ENVIRON			913.74
	NOV2023F	CALPERS_RETIREES			1,510.00
	NOV2023G	CALPERS_WTP			17,854.37
	NOV2023H	CALPERS_ADMIN FEE			245.16

Check No	Vendor No Invoice No	Vendor Name Description	Check Date Reference	Void Checks	Check Amount
	NOV20231	CALPERS_DEPENDENTS			2,446.67
			Total for this ACH Check for Vendor 00178:	0.00	70,349.05
			Total for 11/1/2023:	0.00	92,188.60
ACH	00183 73261 74318	SDRMA INSURANCE_VE#749 VE#748 INSURANCE_VE#750	11/02/2023		1,130.61 308.23
			Total for this ACH Check for Vendor 00183:	0.00	1,438.84
ACH	00450 3800033076 3800033299 3800033501 3800033507 3800033509	EUROFINS WATER ANALYSIS WATER ANALYSIS WATER ANALYSIS WATER ANALYSIS WATER ANALYSIS	11/02/2023		3,350.00 2,055.00 2,740.00 350.00 65.00
			Total for this ACH Check for Vendor 00450:	0.00	8,560.00
ACH	00493 014732	SPRINGBROOK HOLDING COMPANY I MONTHLY CIVICPAY TRANSACTION FEES	11/02/2023		2,298.50
			Total for this ACH Check for Vendor 00493:	0.00	2,298.50
ACH	00711 T686546A T686546B T686546C T686546D T722877A T722877B T722877C	CORE & MAIN LP COLLAR LEAK CLAMP 2" X 7.5" FLEX COUPLING 1-1/4" X 5" FLEX COUPLING 2" X 5" OD 2.000 16 X 125 X1 -TIGERTOOTH SUPERGRIT DIA REPAIR CLAMP 2" X 3" FLANGE RING GASKETS 6" NO BLT REPAIR CLAMP 1" X 3"	11/02/2023		177.23 208.49 277.24 252.72 101.42 29.09 77.83
			Total for this ACH Check for Vendor 00711:	0.00	1,124.02
ACH	00785 2324-CS-12	REGIONAL WATER MANAGEMENT FY2324 COORDINATION SRVCS	11/02/2023		10,000.00
			Total for this ACH Check for Vendor 00785:	0.00	10,000.00
ACH	10133 879294 879296 879297	GRISWOLD INDUSTRIES IRWIN BOOSTER-VALVE REBUILDS IRWIN BOOSTER-VALVE REBUILDS IRWIN BOOSTER-VALVE REBUILDS	11/02/2023		14,558.78 4,349.54 5,230.38
			Total for this ACH Check for Vendor 10133:	0.00	24,138.70
ACH	10402 30396	RAFTELIS FINANCIAL CONSULTANTS 2023 RATE STUDY	11/02/2023		13,055.00
			Total for this ACH Check for Vendor 10402:	0.00	13,055.00
ACH	00011 9946816317A 9946816317B 9946816317C 9946816317D 9946816317E	VERIZON WIRELESS CELL PHONE_ADMIN CELL PHONE_FINANCE CELL PHONE_ENGINEERING CELL PHONE_OPS CELL PHONE_ENVIRON	11/02/2023		44.14 78.82 279.79 292.20 59.23

Check No	Vendor No Invoice No	Vendor Name Description	Check Date Reference	Void Checks	Check Amount
	9946816317F	CELL PHONE_WTP			407.75
	9946816318A	CELLULAR_ADMIN			19.79
	9946816318B	CELLULAR_FINANCE			46.55
	9946816318C	CELLULAR_OPS			469.22
	9946816318D	CELLULAR_WTP			469.70
Total for this ACH Check for Vendor 00011:				0.00	2,167.19
24069	00565	DETLEF ADAM	11/02/2023		
	NOV2023_565	CALPERS_RETIREE			124.00
	OCT2023_565	CALPERS_RETIREE			124.00
	SEPT2023_565	CALPERS_RETIREE			124.00
Total for Check Number 24069:				0.00	372.00
24070	00057	AFSCME COUNCIL 57	11/02/2023		
	OCT2023	UNION DUES_OCTOBER			1,329.21
Total for Check Number 24070:				0.00	1,329.21
24071	10177	ANDERSON PACIFIC ENGINEERING	11/02/2023		
	2398-24-02	QUAIL HOLLOW RD EMERGENCY REPAIR:			322,186.20
Total for Check Number 24071:				0.00	322,186.20
24072	00309	AT&T IP SERVICES	11/02/2023		
	4722292804A	AT&T IP SERVICES_ADMIN			268.37
	4722292804B	AT&T IP SERVICES_OPS			268.37
	4722292804C	AT&T IP SERVICES_WTP			268.37
Total for Check Number 24072:				0.00	805.11
24073	00343	ERNIE'S SERVICE CENTER	11/02/2023		
	112848	REPAIR_VE#338_WO#95			1,242.98
	113162	REPAIR_VE#234_WO#831			133.02
Total for Check Number 24073:				0.00	1,376.00
24074	00204	FEDERAL EXPRESS CORP	11/02/2023		
	8-229-81722	METER RETURN			24.25
Total for Check Number 24074:				0.00	24.25
24075	00367	INFOSEND, INC	11/02/2023		
	248158A	POSTAGE FEES			2,849.32
	248158B	MAILING FEES			1,005.62
Total for Check Number 24075:				0.00	3,854.94
24076	10201	RACHEL MUNOZ	11/02/2023		
	101023_090	POSTAGE			30.90
Total for Check Number 24076:				0.00	30.90
24077	00410	ANDI O'NEAL	11/02/2023		
	103123_093	EMPLOYEE REIMBURSEMENT			218.87
Total for Check Number 24077:				0.00	218.87
24078	00166	SANTA CRUZ COUNTY TAX COLLECT	11/02/2023		
	2212359	PARCEL #07823305_2212859			23.96

Check No	Vendor No Invoice No	Vendor Name Description	Check Date Reference	Void Checks	Check Amount
			Total for Check Number 24078:	0.00	23.96
24079	10119 101823_217	TAYLOR TOCCALINO UNIFORM	11/02/2023		60.36
			Total for Check Number 24079:	0.00	60.36
			Total for 11/2/2023:	0.00	393,064.05
ACH	10207 100623_7861	CITI CARDS_COSTCO COSTCO ANNUAL FEE	11/03/2023		60.00
			Total for this ACH Check for Vendor 10207:	0.00	60.00
24080	00125	SCARBOROUGH LUMBER	11/03/2023		
	413684	OPERATING SUPPLIES			34.51
	413761	SAMPLING SUPPLIES			51.09
	413809	OPERATING SUPPLIES			120.54
	413810	SUPPLIES_RETURN			-22.65
	413841	OPERATING SUPPLIES			32.36
	413994	OPERATING SUPPLIES			47.59
	414002	JOHNSON BLDG_AC INSTALL			89.29
	414090	METER CHANGES WO#901			147.77
	414118	OPERATING SUPPLIES			17.47
	414248	SMALL TOOLS			58.24
	414440	SMALL TOOLS			184.44
	414490	OPERATING SUPPLIES			11.11
	414641	OPERATING SUPPLIES			8.73
	414766.0	OPERATING SUPPLIES			37.12
	414792	OPERATING SUPPLIES			14.54
	414909	OPERATING SUPPLIES			160.39
	414945	OPERATING SUPPLIES			23.28
	414949	OPERATING SUPPLIES			46.43
	446802	OPERATING SUPPLIES			21.71
	446805	OPERATING SUPPLIES			7.81
	5873	OPERATING SUPPLIES			119.07
	5921	OPERATING SUPPLIES			15.09
	5929	POWER TOOLS			1,057.49
	5974	SMALL TOOLS PARTS			75.53
	5975	SMALL TOOLS PARTS			-51.04
	5976	SMALL TOOLS PARTS			106.76
	625739	OPERATING SUPPLIES			43.12
	625864	HYDRANT REPAIR_WO#2183			96.96
	625903	OPERATING SUPPLIES			27.93
	625904	JOHNSON BLDG AC INSTALL			16.96
	625963	OPERATING SUPPLIES			43.96
	625974	SMALL TOOLS			62.57
	625996	OPERATING SUPPLIES			15.10
	626033	OPERATING SUPPLIES			133.76
	626101	OPERATING SUPPLIES			10.54
	626195	OPERATING SUPPLIES			30.42
	626208	OPERATING SUPPLIES			114.37
	626212	OPERATING SUPPLIES			33.43
	626329	OPERATING SUPPLIES			3.87
	626360	OPERATING SUPPLIES			43.67
	626490	OPERATING SUPPLIES			28.14
	626507	OPERATING SUPPLIES			173.53

Check No	Vendor No Invoice No	Vendor Name Description	Check Date Reference	Void Checks	Check Amount
			Total for Check Number 24080:	0.00	3,293.00
			Total for 11/3/2023:	0.00	3,353.00
ACH	00599	WEX BANK	11/05/2023		
	92977879A	FUEL_ADMIN			128.53
	92977879B	FUEL_FINANCE			1,202.86
	92977879C	FUEL_ENGINEERING			735.82
	92977879D	FUEL_OPS			5,451.19
	92977879E	FUEL_WTP			3,507.17
		Total for this ACH Check for Vendor 00599:		0.00	11,025.57
		Total for 11/5/2023:		0.00	11,025.57
ACH	00309	AT&T IP SERVICES	11/06/2023		
	3428463800A	OFFICE PHONES_ADMIN			150.16
	3428463800B	OFFICE PHONES_FINANCE			400.43
	3428463800C	OFFICE PHONES_ENGINEERING			200.22
	3428463800D	OFFICE PHONES_OPS			500.55
	3428463800E	OFFICE PHONES_ENVIRON			50.05
	3995932809	AT&T_195 KIRBY			346.18
	9519903804	AT&T_13060 CENTRAL			1,154.51
		Total for this ACH Check for Vendor 00309:		0.00	2,802.10
		Total for 11/6/2023:		0.00	3,302.10
ACH	00409	EASYPERMIT POSTAGE	11/06/2023		
	101123_4537A	POSTAGE METER MACHINE			50.00
	101123_4537B	POSTAGE METER MACHINE			450.00
		Total for this ACH Check for Vendor 00409:		0.00	500.00
		Total for 11/6/2023:		0.00	3,302.10
ACH	00145	BATTERIES PLUS	11/08/2023		
	P66784152	OPERATING SUPPLIES			45.16
		Total for this ACH Check for Vendor 00145:		0.00	45.16
ACH	00265	COMMUNITY TELEVISION	11/08/2023		
	3329	BOARD COVERAGE_SEPTEMBER			561.75
		Total for this ACH Check for Vendor 00265:		0.00	561.75
ACH	00566	SANTA CRUZ ANSWERING SERVICE	11/08/2023		
	1076810222023A	ANSWERING SERVICE			563.72
		Total for this ACH Check for Vendor 00566:		0.00	563.72
ACH	00711	CORE & MAIN LP	11/08/2023		
	T517526A	MTR CPLG PIPE-MTR 1" X 2"			44.71
	T517526B	CPLG COPR-PIPE FEM 3/4"			242.37
	T654221	CPLG COPR-PIPE MALE 3/4"			100.72
	T669558	FULL CIRCLE 6.56-6.96 7.50"			455.67
	T714591	TRNS 2"IRNML THD-DRS PLS SDR11			459.12
	T763737	REGULATOR 1" 25 AUB			311.96

Check No	Vendor No Invoice No	Vendor Name Description	Check Date Reference	Void Checks	Check Amount
	T765439A	NIPPLE GALV 3/4" X 3-1/2"			1.70
	T765439B	FULL CIRCLE 6.56-6.96 7.50"			206.88
		Total for this ACH Check for Vendor 00711:		0.00	1,823.13
ACH	00944 10606	PDNC, INC. OCTOBER CLOUD SERVICES	11/08/2023		754.04
		Total for this ACH Check for Vendor 00944:		0.00	754.04
ACH	10246 R-62192	OVISS LABS INCORPORATED DVR CLOUD SERVICE	11/08/2023		257.24
		Total for this ACH Check for Vendor 10246:		0.00	257.24
ACH	10344 2023-SLVWD-09	SUSAN ROBINSON GRANT WRITING SERVICES	11/08/2023		1,800.00
		Total for this ACH Check for Vendor 10344:		0.00	1,800.00
ACH	10397 2021CIP5.A 2021CIP5.B 2021CIP5.C 2021CIP5.D 2021CIP5.E LYONBIGSTEEL3.A LYONBIGSTEEL3.B LYONBIGSTEEL3.C	360PSM INC. CERTIFIED PAYROLL MONITORING #2180 CERTIFIED PAYROLL MONITORING #2181 CERTIFIED PAYROLL MONITORING #2182 CERTIFIED PAYROLL MONITORING #2183 CERTIFIED PAYROLL MONITORING #2184 CERTIFIED PAYROLL MONITORING_WO#1 CERTIFIED PAYROLL MONITORING_WO#3 CERTIFIED PAYROLL MONITORING_WO#1	11/08/2023		682.37 682.37 682.38 682.38 682.38 922.71 922.71 922.71
		Total for this ACH Check for Vendor 10397:		0.00	6,180.01
ACH	10398 93811020605010A 93811020605010B 93811020605010C 93811020605010D 93811020605010E PP#6_RETAIN#6A PP#6_RETAIN#6B PP#6_RETAIN#6C PP#6_RETAIN#6D PP#6_RETAIN#6E	JMB CONSTRUCTION, INC. 2021 CIP PIPELINE PROJECT #2180 2021 CIP PIPELINE PROJECT #2181 2021 CIP PIPELINE PROJECT #2182 2021 CIP PIPELINE PROJECT #2183 2021 CIP PIPELINE PROJECT #2184 2021 CIP PIPELINE RETENTION #2180 2021 CIP PIPELINE RETENTION #2181 2021 CIP PIPELINE RETENTION #2182 2021 CIP PIPELINE RETENTION #2183 2021 CIP PIPELINE RETENTION #2184	11/08/2023		9,586.70 3,800.00 696,834.50 3,800.00 3,800.00 504.57 200.00 36,675.50 200.00 200.00
		Total for this ACH Check for Vendor 10398:		0.00	755,601.27
ACH	00566 1076810222023B	SANTA CRUZ ANSWERING SERVICE ANSWERING SERVICE	11/08/2023		563.72
		Total for this ACH Check for Vendor 00566:		0.00	563.72
24081	00958 27113	AIRTEC SERVICE AC REPAIR_365 MADRONE	11/08/2023		622.48
		Total for Check Number 24081:		0.00	622.48
24082	10177 2398-24-03	ANDERSON PACIFIC ENGINEERING QUAIL HOLLOW RD EMERGENCY REPAIR	11/08/2023		324,333.62
		Total for Check Number 24082:		0.00	324,333.62
24083	UB*01022	RICHARD AUGENSTEIN	11/08/2023		

Check No	Vendor No Invoice No	Vendor Name Description	Check Date Reference	Void Checks	Check Amount
		Refund Check 005750-000, 10858 WESTWOO			45.01
			Total for Check Number 24083:	0.00	45.01
24084	01077 102723_212	JOSEPH B BEASLEY UNIFORM	11/08/2023		70.28
			Total for Check Number 24084:	0.00	70.28
24085	00342 958523	BRASS KEY LOCKSMITH LOCKS_JOHNSON BLDG	11/08/2023		60.00
			Total for Check Number 24085:	0.00	60.00
24086	UB*01009	RICHARD CORMIER TRUST Refund Check 008877-000, 14950 HWY 9 Refund Check 008877-000, 14950 HWY 9	11/08/2023		167.10 12.90
			Total for Check Number 24086:	0.00	180.00
24087	UB*01020	HEATHER DANIELS Refund Check 005246-000, 635 SUGAR PINE	11/08/2023		13.50
			Total for Check Number 24087:	0.00	13.50
24088	00703 372017 372279	DATAFLOW BUSINESS SYSTEMS, INC QTRLY PRINTER SERVICES QTRLY PRINTER SERVICES	11/08/2023		128.26 37.85
			Total for Check Number 24088:	0.00	166.11
24089	UB*00994	MARGARET DEASON Refund Check 010878-000, 11370 CLEAR CRE	11/08/2023		200.00
			Total for Check Number 24089:	0.00	200.00
24090	UB*01015	CHELSEA DREW Refund Check 011035-000, 11280 HWY 9 Refund Check 011035-000, 11280 HWY 9	11/08/2023		0.64 2.36
			Total for Check Number 24090:	0.00	3.00
24091	00612 L0459445840	EMPLOYMENT DEVELOPMENT DEPT UNEMPLOYMENT INS BENEFIT CHARGE	11/08/2023		376.85
			Total for Check Number 24091:	0.00	376.85
24092	00076 964543 964631 965282	ERNIE'S AUTO CENTER VEHICLE PARTS RETURN_VEHICLE PARTS PARTS_VE#480 WO#098	11/08/2023		390.42 -17.94 14.15
			Total for Check Number 24092:	0.00	386.63
24093	00343 113184	ERNIE'S SERVICE CENTER TIRES_VE#228_WO#693	11/08/2023		1,181.09
			Total for Check Number 24093:	0.00	1,181.09
24094	00120 7471A-1	GRANITEROCK EMERGENCY REPAIR_INV#3016	11/08/2023		42,549.04

Check No	Vendor No Invoice No	Vendor Name Description	Check Date Reference	Void Checks	Check Amount
			Total for Check Number 24094:	0.00	42,549.04
24095	00550	HACH COMPANY	11/08/2023		
	13784122	WT OPERATING LAB SUPPLIES			263.79
	13786422	WT OPERATING LAB SUPPLIES			451.27
	13789626	WT OPERATING LAB SUPPLIES			164.59
			Total for Check Number 24095:	0.00	879.65
24096	10274	TOM HAVLICK	11/08/2023		
	091123_231	PARTS_VE#749_WO#3034			453.23
	101623_231A	OPERATING SUPPLIES			20.97
	101623_231B	UNIFORM			98.32
			Total for Check Number 24096:	0.00	572.52
24097	UB*00850	STEVEN & JUDY HUBBARD	11/08/2023		
		Refund Check 009458-000, 234 MONTE VIST			456.08
			Total for Check Number 24097:	0.00	456.08
24098	10347	IFLAND SURVEY	11/08/2023		
	7914A	BROOKSIDE DR TOPOGRAPHIC SURVEY_#			9,800.00
	7914B	BROOKSIDE DR RECORD ROW SURVEY_#			7,700.00
			Total for Check Number 24098:	0.00	17,500.00
24099	UB*01017	CODY KANAWYER	11/08/2023		
		Refund Check 012572-000, 7737 HWY 9			37.51
			Total for Check Number 24099:	0.00	37.51
24100	UB*01016	Chris & Shana Kerr	11/08/2023		
		Refund Check 013374-000, 801 DRY WELL RI			45.01
			Total for Check Number 24100:	0.00	45.01
24101	UB*01018	SHEILA LEARY	11/08/2023		
		Refund Check 008725-000, 380 RIVER DR			56.99
			Total for Check Number 24101:	0.00	56.99
24102	10381	WESTON LOCKE	11/08/2023		
	103123_250	UNIFORM			517.64
			Total for Check Number 24102:	0.00	517.64
24103	10424	LOCOMOTOR	11/08/2023		
	1010	SERVICE_VE#300_WO#091			2,311.13
			Total for Check Number 24103:	0.00	2,311.13
24104	UB*01023	CAROLE MONGEAU	11/08/2023		
		Refund Check 016385-000, 925 FOREST WAY			25.00
			Total for Check Number 24104:	0.00	25.00
24105	10120	PACIFIC CREDIT SERVICES	11/08/2023		
	881200000068	COLLECTION FEES			692.87
			Total for Check Number 24105:	0.00	692.87

Check No	Vendor No Invoice No	Vendor Name Description	Check Date Reference	Void Checks	Check Amount
24106	10214	MIKE PODLECH	11/08/2023		
	2494	FALL CREEK HABITAT MONITORING #1738			2,025.00
	2495	CONJUCTIVE USE PLAN			210.00
Total for Check Number 24106:				0.00	2,235.00
24107	00428	RCD OF SANTA CRUZ COUNTY	11/08/2023		
	FLI02A	TASK 1:PRE-CONSTRUCTION SURVEYS			2,290.40
	FLI02B	FALL CREEK_INDIRECT COSTS			466.78
Total for Check Number 24107:				0.00	2,757.18
24108	10151	OSCAR RODAS	11/08/2023		
	122	JOHNSON BLDG MAINT			250.00
Total for Check Number 24108:				0.00	250.00
24109	00142	SAN LORENZO LUMBER	11/08/2023		
	61-0236312	OPERATING SUPPLIES			43.21
	61-0237050	SMALL TOOL MAINTENANCE			27.33
Total for Check Number 24109:				0.00	70.54
24110	UB*01019	J SCHNEIDER	11/08/2023		
		Refund Check 006267-000, 240 CAPELLI DR			190.75
		Refund Check 006267-000, 240 CAPELLI DR			4.05
		Refund Check 006267-000, 240 CAPELLI DR			14.79
Total for Check Number 24110:				0.00	209.59
24111	00168	SCOTTS VALLEY SPRINKLER	11/08/2023		
	31187	OPERATING SUPPLIES			51.60
	31192	OPERATING SUPPLIES			172.07
	31225	OPERATING SUPPLIES			167.77
Total for Check Number 24111:				0.00	391.44
24112	UB*01021	ROBERT STAUFFACHER	11/08/2023		
		Refund Check 010688-000, 830 REBECCA DR			2.72
		Refund Check 010688-000, 830 REBECCA DR			9.94
Total for Check Number 24112:				0.00	12.66
24113	10138	SWRCB - DWOCP	11/08/2023		
	110223_254	T1 CERT_BECK			55.00
Total for Check Number 24113:				0.00	55.00
Total for 11/8/2023:				0.00	1,167,413.46
ACH	00055	AT&T	11/09/2023		
	101923_52736570	AT&T_FELTON ACRES			67.78
Total for this ACH Check for Vendor 00055:				0.00	67.78
Total for 11/9/2023:				0.00	67.78
ACH	01050	COLONIAL LIFE	11/10/2023		
	43777351013434	2023 INSURANCE PREMIUMS			389.32

Check No	Vendor No Invoice No	Vendor Name Description	Check Date Reference	Void Checks	Check Amount
			Total for this ACH Check for Vendor 01050:	0.00	389.32
			Total for 11/10/2023:	0.00	389.32
ACH	00788	COMCAST	11/14/2023		
	101923_6346A	COMCAST_ADMIN			267.23
	101923_6346B	COMCAST_WTP			1,985.81
	101923_6346C	COMCAST_OPS			1,284.87
			Total for this ACH Check for Vendor 00788:	0.00	3,537.91
			Total for 11/14/2023:	0.00	3,537.91
ACH	10005	MISSIONSQUARE RETIREMENT	11/15/2023		
	6666756	PAY PERIOD ENDING 11/01/23			4,553.85
			Total for this ACH Check for Vendor 10005:	0.00	4,553.85
			Total for 11/15/2023:	0.00	4,553.85
ACH	00080	GRANITE CONSTRUCTION CO	11/16/2023		
	2594335	SUPPLIES_BASE ROCK			222.19
	2595162	SUPPLIES_BASE ROCK			494.80
	2596374	SUPPLIES_HOT MIX			1,532.54
			Total for this ACH Check for Vendor 00080:	0.00	2,249.53
ACH	00124	BRUCE BARTON PUMP, INC	11/16/2023		
	0114021-CM	REFUND_FELTON ACRES PUMP			-3,502.19
	0114024	PUMP_FELTON ACRES			3,587.20
			Total for this ACH Check for Vendor 00124:	0.00	85.01
ACH	00711	CORE & MAIN LP	11/16/2023		
	T578840A	METER BOX LID B9 -BADGER ORION			2,618.39
	T578840B	METER BOX LID B16 -BADGER ORION			3,587.03
	T875830A	ELL MJ 6" 22-1/2			189.77
	T875830B	ELL MJ 90 4"			78.41
	T875830C	VALVE BOX RISER GRD RING 1"			568.22
	T875830D	HYDRANT BURY MJXFLGJ 6"x16"			768.95
	T875830E	METER BOX B16			1,528.09
	T875830F	6" MEGA LUG GLAND PACK			316.05
	T875830G	VALVE BOX RISER GRD RING 1-1/2			388.48
	T875830H	GATE VALVE MJ X FLG 4"A2360-16			547.89
	T875830I	PIPE GALV SCHED 40 1-1/2" (21')			236.91
	T875830J	GATE VALVE FLG X FLG 4" SQNUT			1,137.96
			Total for this ACH Check for Vendor 00711:	0.00	11,966.15
ACH	00944	PDNC, INC.	11/16/2023		
	10566	MANAGED ANTIVIRUS_NOVEMBER			717.20
	10611	MS OFFICE LICENSE_ENVIRON			55.29
			Total for this ACH Check for Vendor 00944:	0.00	772.49
ACH	01039	ERA - A WATERS COMPANY	11/16/2023		

Check No	Vendor No Invoice No	Vendor Name Description	Check Date Reference	Void Checks	Check Amount
	058535	LAB SUPPLIES			584.30
			Total for this ACH Check for Vendor 01039:	0.00	584.30
ACH	10184 2023250112883 2023250903884	THATCHER COMPANY, INC TREATMENT CHEMICALS DRUM CREDIT	11/16/2023		5,708.01 -640.00
			Total for this ACH Check for Vendor 10184:	0.00	5,068.01
ACH	10245 1209098930	GOTO TECHNOLOGIES USA, INC. MONTHLY AUDIO SERVICE	11/16/2023		180.00
			Total for this ACH Check for Vendor 10245:	0.00	180.00
ACH	10350 23-596	FREYER & LAURETA, INC. DESIGN SERVICES_FOREMAN PIPELINE #1	11/16/2023		4,132.38
			Total for this ACH Check for Vendor 10350:	0.00	4,132.38
ACH	00054 103023_40624A 103023_40624B 103023_40624C 103023_40624D	PACIFIC GAS AND ELECTRIC PG&E_ADMIN PG&E_OPS PG&E_WTP PG&E_SEWER	11/16/2023		799.18 15,582.49 34,238.79 315.28
			Total for this ACH Check for Vendor 00054:	0.00	50,935.74
24114	00729 3106726	ALPHA ANALYTICAL LABS WASTEWATER MONITORING	11/16/2023		1,550.00
			Total for Check Number 24114:	0.00	1,550.00
24115	00162 000307264267	ANTHEM BLUE CROSS RETIREE MEDICAL	11/16/2023		465.37
			Total for Check Number 24115:	0.00	465.37
24116	00767 000305659728	ANTHEM BLUE CROSS MEDICARE_RETIREE	11/16/2023		90.60
			Total for Check Number 24116:	0.00	90.60
24117	00216 142959	BOULDER CREEK AUTO PARTS PARTS_VE#121_WO#084	11/16/2023		15.00
			Total for Check Number 24117:	0.00	15.00
24118	00750 103123	C.J. BROWN & COMPANY, CPAS AUDIT SERVICES FY2223	11/16/2023		14,150.00
			Total for Check Number 24118:	0.00	14,150.00
24119	00037 46074A 46074B	CO. OF SANTA CRUZ DEPT OF PUBLIC TOILET REBATE DUMP FEES	11/16/2023		84.00 250.07
			Total for Check Number 24119:	0.00	334.07
24120	00343 113276	ERNIE'S SERVICE CENTER SERVICE_VE#255 WO#1701	11/16/2023		133.35

Check No	Vendor No Invoice No	Vendor Name Description	Check Date Reference	Void Checks	Check Amount
			Total for Check Number 24120:	0.00	133.35
24121	00550 13789750	HACH COMPANY WT OPERATING LAB SUPPLIES	11/16/2023		732.70
			Total for Check Number 24121:	0.00	732.70
24122	00615 102723_8423A 102723_8423B 102723_8423C	HOME DEPOT CREDIT SERVICES SMALL TOOLS SMALL TOOLS SMALL TOOLS	11/16/2023		692.12 216.91 271.41
			Total for Check Number 24122:	0.00	1,180.44
24123	00097 8420	JIM WALTERS TRACTOR SERVICE HAULING	11/16/2023		290.00
			Total for Check Number 24123:	0.00	290.00
24124	00082 272737A 272737B	MID VALLEY SUPPLY OFFICE SUPPLIES OFFICE SUPPLIES	11/16/2023		137.61 137.62
			Total for Check Number 24124:	0.00	275.23
24125	00539 0923SLV	MILLER MAXFIELD, INC OUTREACH SERVICES	11/16/2023		3,726.25
			Total for Check Number 24125:	0.00	3,726.25
24126	10004 11.2023	PETTY CASH - RACHEL MUNOZ PETTY CASH REIMBURSEMENT	11/16/2023		63.09
			Total for Check Number 24126:	0.00	63.09
24127	00370 20345	RAC CONSTRUCTION JOHNSON BLDG_DOORS UNIT 1 & 2	11/16/2023		7,777.00
			Total for Check Number 24127:	0.00	7,777.00
24128	00050 090-241-02	CO. OF SANTA CRUZ RECORDER'S OF LIEN RELEASE_090-241-02	11/16/2023		20.00
			Total for Check Number 24128:	0.00	20.00
24129	01052 111523_146	SCOTT MATTOCH RAIN GEAR	11/16/2023		869.82
			Total for Check Number 24129:	0.00	869.82
24130	01075 111623_01075	MPRESS DIGITAL, INC RATE STUDY POSTCARD POSTAGE	11/16/2023		2,583.53
			Total for Check Number 24130:	0.00	2,583.53
			Total for 11/16/2023:	0.00	110,230.06
ACH	00080 2600983	GRANITE CONSTRUCTION CO SUPPLIES_BASE ROCK	11/21/2023		401.34

Check No	Vendor No Invoice No	Vendor Name Description	Check Date Reference	Void Checks	Check Amount
			Total for this ACH Check for Vendor 00080:	0.00	401.34
ACH	00145 P67151013	BATTERIES PLUS SMALL TOOLS	11/21/2023		208.42
			Total for this ACH Check for Vendor 00145:	0.00	208.42
ACH	00220 37410	BAY BUILDING JANITORIAL,INC MONTHLY ADMIN JANITORIAL	11/21/2023		606.66
			Total for this ACH Check for Vendor 00220:	0.00	606.66
ACH	00273 30691697	CORELOGIC, INC. MONTHLY REALQUEST SERVICES	11/21/2023		103.00
			Total for this ACH Check for Vendor 00273:	0.00	103.00
ACH	00450 3800034634 3800034808	EUROFINS WATER ANALYSIS WATER ANALYSIS	11/21/2023		120.00 20.00
			Total for this ACH Check for Vendor 00450:	0.00	140.00
ACH	00711 S658810 T800513 T813897	CORE & MAIN LP MTR VLV PIPE-MTR ANG 1X1" COPR-PIPE FEM 1" 4 HYMAX FLEX CPLG 4.25-5.63	11/21/2023		628.05 308.80 2,141.80
			Total for this ACH Check for Vendor 00711:	0.00	3,078.65
ACH	01053 13-054-TM-7	WATERWAYS CONSULTING, INC. FINAL DESIGN_#1738	11/21/2023		19,254.50
			Total for this ACH Check for Vendor 01053:	0.00	19,254.50
ACH	10025 80141384	BADGER METER, INC MONTHLY BEACON SERVICES	11/21/2023		2,766.45
			Total for this ACH Check for Vendor 10025:	0.00	2,766.45
ACH	10423 15844	REGIONAL GOVERNMENT SERVICES FINANCE CONSULTANT	11/21/2023		3,585.00
			Total for this ACH Check for Vendor 10423:	0.00	3,585.00
24137	00565 DEC2023_565	DETLEF ADAM CALPERS RETIREE	11/21/2023		124.00
			Total for Check Number 24137:	0.00	124.00
24138	10113 DEC2023A DEC2023B	BANK MIDWEST SOLAR LOAN_INTEREST SOLAR LOAN_PRINCIPAL	11/21/2023		338.54 2,911.36
			Total for Check Number 24138:	0.00	3,249.90
24139	00034 DEC2023_034	DAVE BASLER CALPERS RETIREE	11/21/2023		74.00
			Total for Check Number 24139:	0.00	74.00
24140	00099	JOEL BUSA	11/21/2023		

Check No	Vendor No Invoice No	Vendor Name Description	Check Date Reference	Void Checks	Check Amount
	DEC2023_099	CALPERS RETIREE			124.00
			Total for Check Number 24140:	0.00	124.00
24141	00172 DEC 2023_172	JOSEPH F. CONE CALPERS RETIREE	11/21/2023		174.00
			Total for Check Number 24141:	0.00	174.00
24142	00037 103123_P63266	CO. OF SANTA CRUZ DEPT OF PUBLIC INSPECTION_WO#2183	11/21/2023		166.84
			Total for Check Number 24142:	0.00	166.84
24143	00016 0007089740	GREENWASTE RECOVERY,INC MONTHLY DUMPSTER SERVICE	11/21/2023		558.10
			Total for Check Number 24143:	0.00	558.10
24144	00058 07534	IHWY MONTHLY WEBHOSTING	11/21/2023		25.00
			Total for Check Number 24144:	0.00	25.00
24145	00208 DEC2023_208	LEONARD KUHNLEIN CALPERS RETIREE	11/21/2023		124.00
			Total for Check Number 24145:	0.00	124.00
24146	00296 1023012 1023013	MESITI-MILLER ENGINEERING,INC PROJECT MGMNT_BLUE RIDGE TANK #21; PROJECT MGMNT_QUAIL HOLLOW #3016	11/21/2023		7,521.42 746.50
			Total for Check Number 24146:	0.00	8,267.92
24147	00662 DEC2023_662	JAMES A. MUELLER CALPERS RETIREE	11/21/2023		49.00
			Total for Check Number 24147:	0.00	49.00
24148	00350 DEC2023_350	HOWARD OLIPHANT CALPERS RETIREE	11/21/2023		174.00
			Total for Check Number 24148:	0.00	174.00
24149	00142 61-0237819 61-0237820	SAN LORENZO LUMBER OPERATING SUPPLIES OPERATING SUPPLIES	11/21/2023		155.86 16.44
			Total for Check Number 24149:	0.00	172.30
24150	00555 53547992	STORDOK, INC. SHREDDING SERVICES	11/21/2023		55.00
			Total for Check Number 24150:	0.00	55.00
24151	00093 DEC2023_093	JOHN TREGEMBO CALPERS RETIREE	11/21/2023		174.00
			Total for Check Number 24151:	0.00	174.00
24152	00369 DEC2023_369	CAROLE TRIANTAFILLOS CALPERS RETIREE	11/21/2023		124.00

Check No	Vendor No Invoice No	Vendor Name Description	Check Date Reference	Void Checks	Check Amount
			Total for Check Number 24152:	0.00	124.00
24153	00721 02123973	UNITED SITE SVCS.,INC SANITARY SERVICES	11/21/2023		330.24
			Total for Check Number 24153:	0.00	330.24
24154	10426 01_100423	JEFF WALTON PAINT_JOHNSON BLDG	11/21/2023		3,400.00
			Total for Check Number 24154:	0.00	3,400.00
			Total for 11/21/2023:	0.00	47,510.32
ACH	00055	AT&T	11/22/2023		
	110123_5559A	AT&T_ADMIN			2.01
	110123_5559B	AT&T_OPS			2,682.05
	110123_5559C	AT&T_WTP			633.64
	110123_5559D	AT&T_SEWER			270.23
			Total for this ACH Check for Vendor 00055:	0.00	3,587.93
			Total for 11/22/2023:	0.00	3,587.93
ACH	10217	UMPQUA BANK	11/25/2023		
	103123_7268A	KOA_MISC CHARGE			190.84
	103123_7268B	VECMAR_CHECK SCANNER			522.64
	103123_7268C	AMAZON_OFFICE SUPPLIES			9.80
	103123_7268D	AMAZON_MISC CHARGE			21.79
	103123_7268E	AMAZON_MISC CHARGE			105.22
	103123_7268F	AMAZON_ANNUAL MEMBERSHIP			151.51
	103123_7268G.1	AMAZON_OFFICE SUPPLIES			6.47
	103123_7268G.2	AMAZON_OFFICE SUPPLIES			6.45
	103123_7268G.3	AMAZON_OFFICE SUPPLIES			6.45
	103123_7268G.4	AMAZON_OFFICE SUPPLIES			6.45
	103123_7268G.5	AMAZON_OFFICE SUPPLIES			6.45
	103123_7268G.6	AMAZON_OFFICE SUPPLIES			6.45
	103123_7268H	AMAZON_OFFICE SUPPLIES			30.62
	103123_7268I	AMAZON_RAIN GEAR			1,358.14
	103123_7268J	STAPLES_OPERATING SUPPLIES			173.57
	103123_7268K	PACIFIC HIGHWAY RENTALS_SAFETY EQ			3,093.52
	103123_7268L	MAILCHIMP_MARKETING			80.00
	103123_7268M.1	AMAZON_OFFICE SUPPLIES			137.26
	103123_7268M.2	AMAZON_OFFICE SUPPLIES			140.92
	103123_7268M.3	AMAZON_OFFICE SUPPLIES			76.03
	103123_7268M.4	AMAZON_OFFICE SUPPLIES			76.03
	103123_7268N	AMAZON_MISC CHARGE			42.48
	103123_7268O	ZOOM_MONTHLY CHARGES			327.90
	103123_7268P	STAPLES_OFFICE SUPPLIES			113.51
	103123_7268Q	TUTORING CLUB_T1 CERT_244			450.00
	103123_7268R	B&K VALVES_FREIGHT_LYON FILTER			84.65
	103123_7268S	AMAZON_OFFICE SUPPLIES			19.18
	103123_7268T.1	AMAZON_OFFICE SUPPLIES			6.05
	103123_7268T.2	AMAZON_OFFICE SUPPLIES			6.05
	103123_7268T.3	AMAZON_OFFICE SUPPLIES			6.05
	103123_7268T.4	AMAZON_OFFICE SUPPLIES			6.05
	103123_7268T.5	AMAZON_OFFICE SUPPLIES			6.05

Check No	Vendor No Invoice No	Vendor Name Description	Check Date Reference	Void Checks	Check Amount
	103123_7268T.6	AMAZON_OFFICE SUPPLIES			6.04
	103123_7268U	SOCIETY FOR HR_MEMBERSHIP			244.00
	103123_7268V.1	COSTCO_OFFICE CHAIRS			882.87
	103123_7268V.2	COSTCO_OFFICE CHAIRS			294.29
	103123_7268W	COSTCO_ANNUAL MEMBERSHIP			180.00
	103123_7268X	HIRERIGHT_BACKGROUND CHECK			49.00
Total for this ACH Check for Vendor 10217:				0.00	8,930.78
Total for 11/25/2023:				0.00	8,930.78
ACH	10421 43537581	FIRST-CITIZENS BANK & TRUST CO 5 YR LEASE_ADMIN COPIER	11/27/2023		253.45
Total for this ACH Check for Vendor 10421:				0.00	253.45
Total for 11/27/2023:				0.00	253.45
ACH	00687 110523_8730 110623_6881	AT&T U-VERSE UVERSE_13057 HWY 9 UVERSE_MANANA WOODS	11/28/2023		101.65 117.70
Total for this ACH Check for Vendor 00687:				0.00	219.35
Total for 11/28/2023:				0.00	219.35
ACH	10005 6422149	MISSIONSQUARE RETIREMENT PAY PERIOD ENDING 11.15.23	11/29/2023		4,553.85
Total for this ACH Check for Vendor 10005:				0.00	4,553.85
ACH	00687 110723_2018	AT&T U-VERSE UVERSE_345 QUAIL	11/29/2023		107.00
Total for this ACH Check for Vendor 00687:				0.00	107.00
ACH	10421 43545493	FIRST-CITIZENS BANK & TRUST CO 4 YR LEASE_KIRBY COPIER	11/29/2023		159.97
Total for this ACH Check for Vendor 10421:				0.00	159.97
Total for 11/29/2023:				0.00	4,820.82
ACH	00687 110823_2484	AT&T U-VERSE UVERSE_ADMIN FAX LINE	11/30/2023		110.85
Total for this ACH Check for Vendor 00687:				0.00	110.85
ACH	00080 2603597 2604885 2606460 2607339 2609437 2610381	GRANITE CONSTRUCTION CO BASE ROCK HOT MIX BASE ROCK HOT MIX HOT MIX HOT MIX	11/30/2023		324.92 877.45 488.32 380.41 341.17 328.09

Check No	Vendor No Invoice No	Vendor Name Description	Check Date Reference	Void Checks	Check Amount
			Total for this ACH Check for Vendor 00080:	0.00	2,740.36
ACH	00141 534078	B & B SMALL ENGINE SMALL TOOL REPAIR	11/30/2023		46.96
			Total for this ACH Check for Vendor 00141:	0.00	46.96
ACH	00145 P67695872	BATTERIES PLUS OPERATING SUPPLIES_BCEWW	11/30/2023		55.20
			Total for this ACH Check for Vendor 00145:	0.00	55.20
ACH	00164 787548	FIRST ALARM OPERATIONS DEPT_ALARM SERVICES	11/30/2023		123.75
			Total for this ACH Check for Vendor 00164:	0.00	123.75
ACH	00265 3342	COMMUNITY TELEVISION BOARD COVERAGE_OCTOBER	11/30/2023		1,042.00
			Total for this ACH Check for Vendor 00265:	0.00	1,042.00
ACH	00398 7519395	WATSONVILLE METAL CO.,INC RECYCLE/HAUL FEE	11/30/2023		600.00
			Total for this ACH Check for Vendor 00398:	0.00	600.00
ACH	00493 015135	SPRINGBROOK HOLDING COMPANY 1 MONTHLY CIVICPAY TRANSACTION FEES	11/30/2023		2,298.50
			Total for this ACH Check for Vendor 00493:	0.00	2,298.50
ACH	10269 231042-01	AKEL ENGINEERING GROUP, INC. PEER REVIEW_VALLEY GARDEN	11/30/2023		7,985.00
			Total for this ACH Check for Vendor 10269:	0.00	7,985.00
ACH	10277 17001100060408A 17001100060408B	GE DIGITAL LLC HMI SCADA_ANNUAL SUPPORT WTP HMI SCADA_ANNUAL SUPPORT OPS	11/30/2023		4,890.51 4,890.52
			Total for this ACH Check for Vendor 10277:	0.00	9,781.03
ACH	10295 103273 103274	PANORAMA ENVIRONMENTAL INC. FEMA PLANNING/ADMIN FEMA PLANNING/ADMIN	11/30/2023		2,632.50 893.75
			Total for this ACH Check for Vendor 10295:	0.00	3,526.25
ACH	10387 23-1007-6	CBEC, INC CONJUNCTIVE USE TECH SUPPORT #2614	11/30/2023		7,475.50
			Total for this ACH Check for Vendor 10387:	0.00	7,475.50
ACH	10397 LYONBIGSTEEL4A LYONBIGSTEEL4B LYONBIGSTEEL4C	360PSM INC. CERTIFIED PAYROLL MONITORING_WO#1 CERTIFIED PAYROLL MONITORING_WO#3 CERTIFIED PAYROLL MONITORING_WO#1	11/30/2023		643.75 643.75 643.75
			Total for this ACH Check for Vendor 10397:	0.00	1,931.25
ACH	10402	RAFTELIS FINANCIAL CONSULTANTS	11/30/2023		

Check No	Vendor No Invoice No	Vendor Name Description	Check Date Reference	Void Checks	Check Amount
	30805	2023 RATE STUDY			25,138.75
			Total for this ACH Check for Vendor 10402:	0.00	25,138.75
24155	00729 3112972	ALPHA ANALYTICAL LABS WASTEWATER ANALYSIS	11/30/2023		890.00
			Total for Check Number 24155:	0.00	890.00
24156	00216 137883 142711	BOULDER CREEK AUTO PARTS RETURN PARTS_VE#222 WO#89 PARTS_VE#234 WO#831	11/30/2023		-90.12 162.00
			Total for Check Number 24156:	0.00	71.88
24157	00760 28359A 28359B	DYNAMIC PRESS BUSINESS CARDS BUSINESS CARDS	11/30/2023		109.00 54.50
			Total for Check Number 24157:	0.00	163.50
24158	00343 113534	ERNIE'S SERVICE CENTER REPAIR_VE#325 WO#94	11/30/2023		1,322.96
			Total for Check Number 24158:	0.00	1,322.96
24159	10208 003822	GOLDEN STATE COMUNICATIONS, IN LIGHT BAR INSTALL_VE#750 WO#3035	11/30/2023		350.00
			Total for Check Number 24159:	0.00	350.00
24160	00367 249962A 249962B	INFOSEND, INC POSTAGE FEES MAILING FEES	11/30/2023		2,841.24 1,001.78
			Total for Check Number 24160:	0.00	3,843.02
24161	00181 186184	LAS ANIMAS CONCRETE SUPPLIES_CONCRETE	11/30/2023		839.23
			Total for Check Number 24161:	0.00	839.23
24162	00296 1023015	MESITI-MILLER ENGINEERING,INC FISH LADDER_CONST MGMT_WO#1738	11/30/2023		858.00
			Total for Check Number 24162:	0.00	858.00
24163	00410 112123_093	ANDI O'NEAL OFFICE SUPPLIES	11/30/2023		101.30
			Total for Check Number 24163:	0.00	101.30
24164	10425 04500	RALPH ANDERSEN & ASSOCIATES GM RECRUITMENT	11/30/2023		11,570.00
			Total for Check Number 24164:	0.00	11,570.00
24165	00168 31345A 31345B	SCOTTS VALLEY SPRINKLER SMALL TOOLS OPERATING SUPPLIES	11/30/2023		58.83 78.26
			Total for Check Number 24165:	0.00	137.09

Check No	Vendor No Invoice No	Vendor Name Description	Check Date Reference	Void Checks	Check Amount
24166	10138 110223_241	SWRCB - DWOCP T2 CERT_BRUCE	11/30/2023		60.00
			Total for Check Number 24166:	0.00	60.00
24167	10406 4_100923	SYBLON REID FALL CREEK FISH LADDER_WO#1738	11/30/2023		387,153.50
			Total for Check Number 24167:	0.00	387,153.50
24168	10407 48834 48835 48836	WHITE BRENNER LLP LEGAL SERVICES LEGAL SERVICES_BB/FS_#2517 LEGAL SERVICES_OSHA	11/30/2023		16,750.00 450.00 7,800.00
			Total for Check Number 24168:	0.00	25,000.00
			Total for 11/30/2023:	0.00	495,215.88
ACH	00399 819270338A 819270338B 819270338C 819270338D 819270338E 819270338F	VISION SERVICE PLAN - (CA) VISION_ADMIN VISION_FINANCE VISION_ENG VISION_OPS VISION_ENVIRON VISION_WTP	12/01/2023		28.44 122.90 56.88 247.12 22.28 210.22
			Total for this ACH Check for Vendor 00399:	0.00	687.84
ACH	00545 912375	AFLAC 2023 INSURANCE PREMIUMS	12/01/2023		122.21
			Total for this ACH Check for Vendor 00545:	0.00	122.21
ACH	00313 111423_313A 111423_313B 111423_313C 111423_313D 111423_313E 111423_313F 111423_313G 111423_313H 111423_313I 111423_313J 111423_313K 111423_313L 111423_313M 111423_313N 111423_313O 111423_313P 111423_313Q 111423_313R	MET LIFE DENTAL_ADMIN DISABILITY_ADMIN LIFE INS_ADMIN DENTAL_FINANCE DISABILITY_FINANCE LIFE INS_FINANCE DENTAL_ENG DISABILITY_ENG LIFE INS_ENG DENTAL_OPS DISABILITY_OPS LIFE INS_OPS DENTAL_ENVIRON DISABILITY_ENVIRON LIFE INS_ENVIRON DENTAL_WTP DISABILITY_WTP LIFE INS_WTP	12/01/2023		199.82 86.12 21.64 791.41 213.61 108.23 399.64 184.92 66.60 1,652.80 300.53 159.84 65.07 32.40 16.65 1,436.89 285.96 139.86
			Total for this ACH Check for Vendor 00313:	0.00	6,161.99
ACH	00178 DEC2023A DEC2023B DEC2023C	CALPERS CALPERS_ADMIN CALPERS_FINANCE CALPERS_ENG	12/01/2023		2,956.31 13,624.35 5,901.94

Check No	Vendor No Invoice No	Vendor Name Description	Check Date Reference	Void Checks	Check Amount
	DEC2023D	CALPERS_OPS			22,520.79
	DEC2023E	CALPERS_ENVIRON			1,827.48
	DEC2023F	CALPERS_RETIREEES			1,510.00
	DEC2023G	CALPERS_WTP			17,854.37
	DEC2023H	CALPERS_ADMIN FEE			240.48
	DEC2023I	CALPERS_DEPENDENTS			2,446.67
Total for this ACH Check for Vendor 00178:				0.00	68,882.39
24169	00125	SCARBOROUGH LUMBER	12/01/2023		
	415232	OPERATING SUPPLIES			201.77
	415245A	OPERATING SUPPLIES			19.41
	415245B	SMALL TOOLS			64.73
	415511	OPERATING SUPPLIES			143.43
	415531	OPERATING SUPPLIES			130.94
	415533	OPERATING SUPPLIES			7.75
	415592	OPERATING SUPPLIES			95.67
	415604	SMALL TOOLS PARTS			2.30
	415669	OPERATING SUPPLIES			222.20
	416194	OPERATING SUPPLIES			21.57
	416288	LAB SUPPLIES			48.39
	416292	OPERATING SUPPLIES			222.34
	416340	OPERATING SUPPLIES			102.86
	416352	OPERATING SUPPLIES			44.38
	416406	OPERATING SUPPLIES_BCEWW			19.41
	416488	CLEANING SUPPLIES			81.93
	416689	OPERATING SUPPLIES			42.15
	416694	OPERATING SUPPLIES			0.67
	416753	OPERATING SUPPLIES			60.71
	416764	OPERATING SUPPLIES			9.59
	447607	SMALL TOOLS PARTS			72.76
	5998	LAB SUPPLIES			6.45
	6001	SMALL TOOLS			36.68
	6057	SMALL TOOLS PARTS			61.49
	6060	SMALL TOOLS PARTS			56.08
	6074	OPERATING SUPPLIES			42.07
	6076	RETURN_OPERATING SUPPLIES			-2.62
	626667	OPERATING SUPPLIES			29.12
	626672	OPERATING SUPPLIES			16.49
	626699	OPERATING SUPPLIES			4.83
	626753	OPERATING SUPPLIES			35.40
	626842	OPERATING SUPPLIES			29.13
	626845	OPERATING SUPPLIES			37.76
	626872	OPERATING SUPPLIES			13.58
	626882	OPERATING SUPPLIES			5.82
	626945	OPERATING SUPPLIES			67.95
	626947	OPERATING SUPPLIES			20.49
	627099	OPERATING SUPPLIES_BCEWW			85.21
	627105	OPERATING SUPPLIES_BCEWW			36.67
	627166	LAB SUPPLIES			9.14
	627264	OPERATING SUPPLIES			33.28
	627265	OPERATING SUPPLIES			4.65
	627268	OPERATING SUPPLIES			15.51
Total for Check Number 24169:				0.00	2,260.14
Total for 12/1/2023:				0.00	78,114.57
ACH	10207	CITI CARDS_COSTCO	12/03/2023		

Check No	Vendor No Invoice No	Vendor Name Description	Check Date Reference	Void Checks	Check Amount
	110723_7681A	DESK_ENVIRON			137.33
	110723_7681B	OFFICE SUPPLIES			129.71
		Total for this ACH Check for Vendor 10207:		0.00	267.04
		Total for 12/3/2023:		0.00	267.04
ACH	00011	VERIZON WIRELESS	12/05/2023		
	9949255185A	CELL PHONE_ADMIN			41.33
	9949255185B	CELL PHONE_FINANCE			78.81
	9949255185C	CELL PHONE_ENG			197.30
	9949255185D	CELL PHONE_OPS			292.19
	9949255185E	CELL PHONE_ENVIRON			59.22
	9949255185F	CELL PHONE_WTP			325.25
	9949255186A	CELLULAR_ADMIN			19.79
	9949255186B	CELLULAR_FINANCE			76.57
	9949255186C	CELLULAR_OPS			468.93
	9949255186D	CELLULAR_WTP			139.70
		Total for this ACH Check for Vendor 00011:		0.00	1,699.09
		Total for 12/5/2023:		0.00	1,699.09
ACH	00329	GRAINGER	12/07/2023		
	9906392304	OPERATING SUPPLIES			1,114.12
		Total for this ACH Check for Vendor 00329:		0.00	1,114.12
ACH	00336	LAND TRUST OF SANTA CRUZ COUN	12/07/2023		
	7-2232	PATROLS OF OLYMPIA WATER STATION			158.32
		Total for this ACH Check for Vendor 00336:		0.00	158.32
ACH	00450	EUROFINS	12/07/2023		
	3800036751	WATER ANALYSIS			120.00
		Total for this ACH Check for Vendor 00450:		0.00	120.00
ACH	00493	SPRINGBROOK HOLDING COMPANY I	12/07/2023		
	014979	IVR SUBSCRIPTION RENEWAL			11,410.00
	015326	MONTHLY CIVICPAY TRANSACTION FEES			2,317.50
	CM-000646	CREDIT MEMO			-2,298.50
		Total for this ACH Check for Vendor 00493:		0.00	11,429.00
ACH	00609	BALANCE HYDROLOGICS, INC	12/07/2023		
	222118-1023	WY22 OPERATIONAL TEMP & FLOW MONI			6,063.68
		Total for this ACH Check for Vendor 00609:		0.00	6,063.68
ACH	00727	ULINE SHIPPING SUPPLIES	12/07/2023		
	170885275	OPERATING SUPPLIES			257.41
	170959931	INVENTORY_MARKING PAINT			135.22
		Total for this ACH Check for Vendor 00727:		0.00	392.63
ACH	00944	PDNC, INC.	12/07/2023		
	10702	MANAGED ANTIVIRUS_NOVEMBER			717.20
	10733	NOVEMBER CLOUD SERVICES			714.29

Check No	Vendor No Invoice No	Vendor Name Description	Check Date Reference	Void Checks	Check Amount
			Total for this ACH Check for Vendor 00944:	0.00	1,431.49
ACH	10344 2023-SLVWD-10	SUSAN ROBINSON GRANT WRITING SERVICES	12/07/2023		1,200.00
			Total for this ACH Check for Vendor 10344:	0.00	1,200.00
ACH	00309 6770943801 7527014803 7989634801A 7989634801B 7989634801C 7989634801D 7989634801E	AT&T IP SERVICES AT&T_13060 CENTRAL AT&T_195 KIRBY OFFICE AT HAND_ADMIN OFFICE AT HAND_FINANCE OFFICE AT HAND_ENGINEERING OFFICE AT HAND_OPS OFFICE AT HAND_ENVIRON	12/07/2023		1,154.51 346.18 91.19 243.16 121.58 303.96 30.40
			Total for this ACH Check for Vendor 00309:	0.00	2,290.98
24170	00216 144034	BOULDER CREEK AUTO PARTS PARTS_VE#325 WO#117	12/07/2023		2.01
			Total for Check Number 24170:	0.00	2.01
24171	10427 113023_07516220	BRIAN BROWN PROPERTY TAX LIEN REFUND	12/07/2023		1,512.91
			Total for Check Number 24171:	0.00	1,512.91
24172	00415 6759_DEC2023	CA BANK & TRUST/GOV SVC DEPT_10 2023 CB&T BIANNUAL PMT_FELTON BONI	12/07/2023		93,400.00
			Total for Check Number 24172:	0.00	93,400.00
24173	10302 DEC2023_0590	CA BANT & TRUST/GOV SVC DEPT_57 2023 CB&T BI-ANNUAL PAYMENT_OLYMP	12/07/2023		52,200.00
			Total for Check Number 24173:	0.00	52,200.00
24174	00293 1223_NOE HARMON	CO. OF SANTA CRUZ CLERK OF THE E NOE_HARMON PIPELINE WO#1953	12/07/2023		50.00
			Total for Check Number 24174:	0.00	50.00
24175	00076 968738	ERNIE'S AUTO CENTER PARTS_VE#238_WO#1207	12/07/2023		28.31
			Total for Check Number 24175:	0.00	28.31
24176	00343 113834	ERNIE'S SERVICE CENTER SERVICE_VE#240_WO#1206	12/07/2023		1,015.26
			Total for Check Number 24176:	0.00	1,015.26
24177	00539 1023SLV	MILLER MAXFIELD, INC OUTREACH SERVICES	12/07/2023		10,388.75
			Total for Check Number 24177:	0.00	10,388.75
24178	10428 111523_260	DAMIAN MOORE UNIFORM	12/07/2023		76.80

Check No	Vendor No Invoice No	Vendor Name Description	Check Date Reference	Void Checks	Check Amount
			Total for Check Number 24178:	0.00	76.80
24179	01075 20995	MPRESS DIGITAL, INC RATE STUDY POSTCARD	12/07/2023		2,830.37
			Total for Check Number 24179:	0.00	2,830.37
24180	10214 2506	MIKE PODLECH CONJUCTIVE USE PLAN_FY2223	12/07/2023		630.00
			Total for Check Number 24180:	0.00	630.00
24181	10151 133	OSCAR RODAS JOHNSON BLDG MAINT	12/07/2023		250.00
			Total for Check Number 24181:	0.00	250.00
24182	00142 61-0239100	SAN LORENZO LUMBER OPERATING SUPPLIES	12/07/2023		46.43
			Total for Check Number 24182:	0.00	46.43
24183	00047 3110139 3110140 3110141 3110244 3110246	SOIL CONTROL LAB WATER ANALYSIS WATER ANALYSIS WATER ANALYSIS WATER ANALYSIS WATER ANALYSIS	12/07/2023		78.00 196.00 49.00 49.00 196.00
			Total for Check Number 24183:	0.00	568.00
24184	10426 01_113023	JEFF WALTON PAINT_JOHNSON BLDG	12/07/2023		4,259.50
			Total for Check Number 24184:	0.00	4,259.50
			Total for 12/7/2023:	0.00	191,458.56
ACH	01050 43777351113387	COLONIAL LIFE 2023 INSURANCE PREMIUMS	12/10/2023		389.82
			Total for this ACH Check for Vendor 01050:	0.00	389.82
			Total for 12/10/2023:	0.00	389.82
ACH	00309 3318763807A 3318763807B 3318763807C	AT&T IP SERVICES IP SERVICES_ADMIN IP SERVICES_OPS IP SERVICES_WTP	12/11/2023		268.37 268.37 268.37
			Total for this ACH Check for Vendor 00309:	0.00	805.11
			Total for 12/11/2023:	0.00	805.11
ACH	10005 6744321	MISSIONSQUARE RETIREMENT PAY PERIOD ENDING 11/29/23	12/13/2023		4,463.85

Check No	Vendor No Invoice No	Vendor Name Description	Check Date Reference	Void Checks	Check Amount
			Total for this ACH Check for Vendor 10005:	0.00	4,463.85
ACH	00055 111923_52736570	AT&T AT&T_FELTON ACRES	12/13/2023		69.84
			Total for this ACH Check for Vendor 00055:	0.00	69.84
			Total for 12/13/2023:	0.00	4,533.69
ACH	00268 13132	WATTS ON GENERATOR SERVICE_ZAYANTE	12/14/2023		442.00
			Total for this ACH Check for Vendor 00268:	0.00	442.00
ACH	00351 22090019419	A DIVISION OF BRAY SALES INC. T&T KIRBY PLANT VALVES	12/14/2023		2,313.96
			Total for this ACH Check for Vendor 00351:	0.00	2,313.96
ACH	00505 10711788511	DELL MARKETING LP DELL MARKETING QUOTE#3000168273863.	12/14/2023		406.74
			Total for this ACH Check for Vendor 00505:	0.00	406.74
ACH	00566 1076811222023A 1076811222023B	SANTA CRUZ ANSWERING SERVICE ANSWERING SERVICE ANSWERING SERVICE	12/14/2023		950.92 950.92
			Total for this ACH Check for Vendor 00566:	0.00	1,901.84
ACH	00609 223018-1023A 223018-1023B	BALANCE HYDROLOGICS, INC STREAMFLOW MONITORING OPERATIONAL GAUGING	12/14/2023		12,887.12 1,335.37
			Total for this ACH Check for Vendor 00609:	0.00	14,222.49
ACH	00711 T843248 T856170A T856170B T856170C T856170D T856170E T856170F T856170G T856170H T856170I T856170J T856170K T856170L T856170M T856170N T856170O T856170P T856170Q T967855A T967855B T967855C T967855D	CORE & MAIN LP OPERATING SUPPLIES BUSHING GALV 3/4" X 1/2" UNION GALV 2" TEE GALV 1/2" ELL 90 STREET GALV 1/2" NIPPLE GALV 2" X 6" NIPPLE BRASS 3/4" X 0" FLANGE RING GASKETS 6" NO BLT GATE VALVE 4" CHECK VALVE METER SPUD 1" 1" AIR RELEASE VALVE #50 SVC VALVE PIPE-PIPE STRT 1" MTR CPLG PIPE-MTR 1" X 2" FULL CIRCLE 1-1/4-3 REDI-CL244 FULL CIRCLE 2"-3" REDI-CLP 244 FULL CIRCLE 2.35-2.63 12.50" METER FLANGE BRONZE 2" WHITE PAINT WATERBASE #3901 BELL REDCR GALV 3/4" X 1/2" NIPPLE GALV 2" X 4" REPAIR CLAMP 3/4" X 3" REPAIR CLAMP 1" X 3"	12/14/2023		378.02 5.08 100.93 9.59 16.55 22.86 21.02 48.05 1,171.01 231.73 349.43 261.16 46.35 110.43 124.23 268.77 450.01 91.25 4.34 5.13 71.26 111.18

Check No	Vendor No Invoice No	Vendor Name Description	Check Date Reference	Void Checks	Check Amount
	T967855E	REPAIR CLAMP 1-1/2" X 6"			125.50
	T967855F	REPAIR CLAMP 2" X 3"			183.43
	T967855G	FULL CIRCLE 2"-6" REDI-CLP 244			242.67
	T967855H	COLLAR LEAK CLAMP 2" X 7.5"			177.28
	T967855I	FLEX COUPLING 1-1/4" X 5"			341.65
	T967855J	FLEX COUPLING 2" X 5" OD 2.000			388.14
	T991218	OPERATING SUPPLIES			697.18
	T993614	METER BOX LID B9 -BADGER ORION			27,051.08
		Total for this ACH Check for Vendor 00711:		0.00	33,105.31
ACH	00782	MONTEREY PENINSULA ENGINEERIN	12/14/2023		
	09-23_PP#4	LYON & BIG STEEL PIPELINE PROJECT WC			269,562.50
	10-28_PP#5	LYON & BIG STEEL PIPELINE #3068			1,103,654.90
		Total for this ACH Check for Vendor 00782:		0.00	1,373,217.40
ACH	10245	GOTO TECHNOLOGIES USA, INC.	12/14/2023		
	1209115123	MONTHLY AUDIO SERVICE			180.00
		Total for this ACH Check for Vendor 10245:		0.00	180.00
ACH	10246	OVISS LABS INCORPORATED	12/14/2023		
	R-62847	DVR CLOUD SERVICE			257.24
	R-63193	DVR CLOUD SERVICE			192.93
		Total for this ACH Check for Vendor 10246:		0.00	450.17
ACH	10308	SANDIS	12/14/2023		
	2310357	CONSTRUCTION MGMT _ALTA VIA PIPELIN			164.13
	2310358	CONSTRUCTION MGMT _ALTA VIA PIPELIN			16,908.75
		Total for this ACH Check for Vendor 10308:		0.00	17,072.88
ACH	10350	FREYER & LAURETA, INC.	12/14/2023		
	23-660	DESIGN_FOREMAN PRESSURE BREAK_#21			1,375.00
		Total for this ACH Check for Vendor 10350:		0.00	1,375.00
ACH	10396	BECK'S SHOES	12/14/2023		
	273123	UNIFORM_BOOTS			241.81
		Total for this ACH Check for Vendor 10396:		0.00	241.81
ACH	10397	360PSM INC.	12/14/2023		
	2021CIP6.A	CERTIFIED PAYROLL MONITORING #2180			669.50
	2021CIP6.B	CERTIFIED PAYROLL MONITORING #2181			669.50
	2021CIP6.C	CERTIFIED PAYROLL MONITORING #2182			669.50
	2021CIP6.D	CERTIFIED PAYROLL MONITORING #2183			669.50
	2021CIP6.E	CERTIFIED PAYROLL MONITORING #2184			669.50
		Total for this ACH Check for Vendor 10397:		0.00	3,347.50
ACH	00788	COMCAST	12/14/2023		
	111923_6346A	COMCAST_ADMIN			267.44
	111923_6346B	COMCAST_WTP			1,985.81
	111923_6346C	COMCAST_OPS			1,284.87
		Total for this ACH Check for Vendor 00788:		0.00	3,538.12
ACH	10239	CDTFA	12/14/2023		
	L0023522247	FY2324 WATER RIGHTS			2,856.05

Check No	Vendor No Invoice No	Vendor Name Description	Check Date Reference	Void Checks	Check Amount
			Total for this ACH Check for Vendor 10239:	0.00	2,856.05
24185	00383 1668638-5	A TOOL SHED EQUIP RENTAL_CHIPPER	12/14/2023		1,020.19
			Total for Check Number 24185:	0.00	1,020.19
24186	00729 3114935	ALPHA ANALYTICAL LABS WASTEWATER MONITORING	12/14/2023		1,620.00
			Total for Check Number 24186:	0.00	1,620.00
24187	00342 958769	BRASS KEY LOCKSMITH KEYS_VE#232_WO#685	12/14/2023		53.73
			Total for Check Number 24187:	0.00	53.73
24188	00703 374928	DATAFLOW BUSINESS SYSTEMS, INC PRINTER SERVICE	12/14/2023		38.97
			Total for Check Number 24188:	0.00	38.97
24189	00037 46340A 46340B	CO. OF SANTA CRUZ DEPT OF PUBLIC TOILET REBATE DUMP FEES	12/14/2023		56.00 391.36
			Total for Check Number 24189:	0.00	447.36
24190	00016 0007149161	GREENWASTE RECOVERY, INC MONTHLY DUMPSTER SERVICE	12/14/2023		558.10
			Total for Check Number 24190:	0.00	558.10
24191	00769 012023	HIGHLANDS PARK SENIOR CTR. FACILITY RENTAL_PUBLIC MEETING	12/14/2023		550.00
			Total for Check Number 24191:	0.00	550.00
24192	00058 07577	IHWY MONTHLY WEBHOSTING	12/14/2023		25.00
			Total for Check Number 24192:	0.00	25.00
24193	10430 121223_263A 121223_263B	CHRIS KLIER MILEAGE REIMBURSEMENT UNIFORM	12/14/2023		62.38 150.00
			Total for Check Number 24193:	0.00	212.38
24194	00181 186511	LAS ANIMAS CONCRETE SUPPLIES_CONCRETE	12/14/2023		857.38
			Total for Check Number 24194:	0.00	857.38
24195	00082 273162A 273162B	MID VALLEY SUPPLY OFFICE SUPPLIES OFFICE SUPPLIES	12/14/2023		160.22 183.48
			Total for Check Number 24195:	0.00	343.70
24196	00410 120523_093	ANDI O'NEAL EMPLOYEE APPRECIATION EVENT	12/14/2023		221.60

Check No	Vendor No Invoice No	Vendor Name Description	Check Date Reference	Void Checks	Check Amount
			Total for Check Number 24196:	0.00	221.60
24197	00050 089-271-13	CO. OF SANTA CRUZ RECORDER'S OF LIEN RELEASE_089-271-13	12/14/2023		20.00
			Total for Check Number 24197:	0.00	20.00
24198	00047 3110446 3110448	SOIL CONTROL LAB WATER ANALYSIS WATER ANALYSIS	12/14/2023		196.00 49.00
			Total for Check Number 24198:	0.00	245.00
24199	00722 WD-0230827	SWRCB - ELAP ANNUAL PERMIT_ID#4DW0117	12/14/2023		1,214.00
			Total for Check Number 24199:	0.00	1,214.00
24200	00722 WD-0230826	SWRCB - ELAP ANNUAL PERMIT_ID#4DW0113	12/14/2023		868.00
			Total for Check Number 24200:	0.00	868.00
24201	00722 WD-0230440	SWRCB - ELAP ANNUAL PERMIT_ID#3SSO10226	12/14/2023		3,746.00
			Total for Check Number 24201:	0.00	3,746.00
24202	00722 WD-0230632	SWRCB - ELAP ANNUAL PERMIT_ID#3440107001	12/14/2023		10,043.00
			Total for Check Number 24202:	0.00	10,043.00
24203	10429 121223	KATHERINE WOODTHROP INSTALLATION DEPOSIT REFUND	12/14/2023		3,428.17
			Total for Check Number 24203:	0.00	3,428.17
			Total for 12/14/2023:	0.00	1,480,183.85
ACH	00054 112923_40624A 112923_40624B 112923_40624C 112923_40624D	PACIFIC GAS AND ELECTRIC PG&E_ADMIN PG&E_OPS PG&E_WTP PG&E_SEWER	12/18/2023		726.75 13,588.35 30,883.80 264.29
			Total for this ACH Check for Vendor 00054:	0.00	45,463.19
			Total for 12/18/2023:	0.00	45,463.19
ACH	00067 MEMBER252-2024	CALIFORNIA SPECIAL DISTRICT MEMBER #252_2024	12/21/2023		9,050.00
			Total for this ACH Check for Vendor 00067:	0.00	9,050.00
ACH	00080 2618893 2621551 2623253	GRANITE CONSTRUCTION CO SUPPLIES_HOT MIX SUPPLIES_BASE ROCK SUPPLIES_HOT MIX	12/21/2023		231.08 124.52 272.50

Check No	Vendor No Invoice No	Vendor Name Description	Check Date Reference	Void Checks	Check Amount
			Total for this ACH Check for Vendor 00080:	0.00	628.10
ACH	00100 JAN2024_100	RICK ROGERS CALPERS RETIREE	12/21/2023		118.00
			Total for this ACH Check for Vendor 00100:	0.00	118.00
ACH	00164 788233	FIRST ALARM BCEWW_ALARM SERVICES	12/21/2023		191.16
			Total for this ACH Check for Vendor 00164:	0.00	191.16
ACH	00220 37533	BAY BUILDING JANITORIAL,INC MONTHLY ADMIN JANITORIAL	12/21/2023		606.66
			Total for this ACH Check for Vendor 00220:	0.00	606.66
ACH	00273 30695193A 30695193B	CORELOGIC, INC. MONTHLY REALQUEST SERVICES MONTHLY REALQUEST SERVICES	12/21/2023		43.76 59.24
			Total for this ACH Check for Vendor 00273:	0.00	103.00
ACH	00329 9923480959	GRAINGER OPERATING SUPPLIES	12/21/2023		31.70
			Total for this ACH Check for Vendor 00329:	0.00	31.70
ACH	00711 T935164	CORE & MAIN LP COMPRESSION COUPLING 1" G/T	12/21/2023		756.81
			Total for this ACH Check for Vendor 00711:	0.00	756.81
ACH	00727 171431715	ULINE SHIPPING SUPPLIES OPERATING SUPPLIES	12/21/2023		1,449.68
			Total for this ACH Check for Vendor 00727:	0.00	1,449.68
ACH	10025 80144022	BADGER METER, INC MONTHLY BEACON SERVICES	12/21/2023		2,774.11
			Total for this ACH Check for Vendor 10025:	0.00	2,774.11
ACH	10184 2023250113493 2023250904029	THATCHER COMPANY, INC TREATMENT CHEMICALS DRUM CREDIT	12/21/2023		5,341.26 -640.00
			Total for this ACH Check for Vendor 10184:	0.00	4,701.26
ACH	10276 229728 229786	MONRO INC MAINT_VE#242_WO#1699 TIRES_VE#211_WO#112	12/21/2023		140.31 402.20
			Total for this ACH Check for Vendor 10276:	0.00	542.51
ACH	10387 23-1007-7	CBEC, INC CONJUNCTIVE USE TECH SUPPORT #2614	12/21/2023		4,953.00
			Total for this ACH Check for Vendor 10387:	0.00	4,953.00
ACH	10393 9018691343	RS AMERICAS, INC. OPERATING SUPPLIES	12/21/2023		38.77

Check No	Vendor No Invoice No	Vendor Name Description	Check Date Reference	Void Checks	Check Amount
			Total for this ACH Check for Vendor 10393:	0.00	38.77
ACH	10402 31308	RAFTELIS FINANCIAL CONSULTANTS 2023 RATE STUDY	12/21/2023		9,601.25
			Total for this ACH Check for Vendor 10402:	0.00	9,601.25
ACH	10423 16000	REGIONAL GOVERNMENT SERVICES FINANCE CONSULTANT	12/21/2023		5,595.00
			Total for this ACH Check for Vendor 10423:	0.00	5,595.00
24204	00565 JAN2023_565	DETLEF ADAM CALPERS RETIREE	12/21/2023		118.00
			Total for Check Number 24204:	0.00	118.00
24205	00729 3116083	ALPHA ANALYTICAL LABS WASTEWATER MONITORING	12/21/2023		690.00
			Total for Check Number 24205:	0.00	690.00
24206	10177 7_ALTA VIA	ANDERSON PACIFIC ENGINEERING ALTA VIA PIPELINE REPLACEMENT_#1921	12/21/2023		186,048.00
			Total for Check Number 24206:	0.00	186,048.00
24207	00162 000311206389	ANTHEM BLUE CROSS RETIREE MEDICAL	12/21/2023		465.37
			Total for Check Number 24207:	0.00	465.37
24208	00767 000309640778	ANTHEM BLUE CROSS MEDICARE_RETIREE	12/21/2023		100.60
			Total for Check Number 24208:	0.00	100.60
24209	10113 JAN2024_1011A JAN2024_1011B	BANK MIDWEST SOLAR LOAN_INTEREST SOLAR LOAN_PRINCIPAL	12/21/2023		329.63 2,920.27
			Total for Check Number 24209:	0.00	3,249.90
24210	00034 JAN2024_034	DAVE BASLER CALPERS RETIREE	12/21/2023		68.00
			Total for Check Number 24210:	0.00	68.00
24211	10431 122023_254	BEN BECK OFFICE SUPPLIES	12/21/2023		36.40
			Total for Check Number 24211:	0.00	36.40
24212	00216 144059 144061 144068 145210	BOULDER CREEK AUTO PARTS PARTS_VE#480_WO#98 VEHICLE SUPPLIES PARTS_VE#480_WO#98 POWER TOOL MAINT	12/21/2023		21.80 39.17 12.00 27.99
			Total for Check Number 24212:	0.00	100.96
24213	00099	JOEL BUSA	12/21/2023		

Check No	Vendor No Invoice No	Vendor Name Description	Check Date Reference	Void Checks	Check Amount
	JAN2024_099	CALPERS RETIREE			118.00
			Total for Check Number 24213:	0.00	118.00
24214	00172 JAN2024_172	JOSEPH F. CONE CALPERS RETIREE	12/21/2023		168.00
			Total for Check Number 24214:	0.00	168.00
24215	00312 16.17	DOCTORS ON DUTY EMPLOYEE PHYSICALS	12/21/2023		160.00
			Total for Check Number 24215:	0.00	160.00
24216	00343 107390 114089	ERNIE'S SERVICE CENTER SERVICE_VE#335_WO#94 SERVICE_VE#224_WO#109	12/21/2023		751.64 44.78
			Total for Check Number 24216:	0.00	796.42
24217	00550 13832996 13837044	HACH COMPANY WT OPERATING LAB SUPPLIES LAB SUPPLIES	12/21/2023		3,299.89 507.95
			Total for Check Number 24217:	0.00	3,807.84
24218	00367 251767A 251767B	INFOSEND, INC POSTAGE FEES POSTAGE FEES	12/21/2023		2,837.88 1,000.03
			Total for Check Number 24218:	0.00	3,837.91
24219	00208 JAN2024_208	LEONARD KUHNLEIN CALPERS RETIREE	12/21/2023		118.00
			Total for Check Number 24219:	0.00	118.00
24220	00296 1123016	MESITI-MILLER ENGINEERING,INC FISH LADDER_CONST MGMT_WO#1738	12/21/2023		858.00
			Total for Check Number 24220:	0.00	858.00
24221	00662 JAN2024_662	JAMES A. MUELLER CALPERS RETIREE	12/21/2023		43.00
			Total for Check Number 24221:	0.00	43.00
24222	10348 1155A 1155B	POWERS FORESTRY LLC ANNUAL TANK MAINTENANCE ANNUAL TANK MAINTENANCE	12/21/2023		18,800.00 18,800.00
			Total for Check Number 24222:	0.00	37,600.00
24223	00050 072-075-10	CO. OF SANTA CRUZ RECORDER'S OF LIEN RELEASE_072-075-10	12/21/2023		20.00
			Total for Check Number 24223:	0.00	20.00
24224	00168 314619	SCOTTS VALLEY SPRINKLER OPERATING SUPPLIES	12/21/2023		514.09
			Total for Check Number 24224:	0.00	514.09

Check No	Vendor No Invoice No	Vendor Name Description	Check Date Reference	Void Checks	Check Amount
24225	00047	SOIL CONTROL LAB	12/21/2023		
	3110245	WATER ANALYSIS			195.00
	3110447	WATER ANALYSIS			78.00
	3110537	WATER ANALYSIS			78.00
	3120101	WATER ANALYSIS			49.00
	3120102	WATER ANALYSIS			196.00
					<hr/>
Total for Check Number 24225:				0.00	596.00
24226	00722	SWRCB - ELAP	12/21/2023		
	EA-RE-0224-2117	ANNUAL FEES			4,615.00
					<hr/>
Total for Check Number 24226:				0.00	4,615.00
24227	00510	TOM'S SEPTIC CONSTRUCTION	12/21/2023		
	87213	BCE WASTEWATER PUMPOUT			5,325.00
					<hr/>
Total for Check Number 24227:				0.00	5,325.00
24228	00093	JOHN TREGEMBO	12/21/2023		
	JAN2024_093	CALPERS RETIREE			168.00
					<hr/>
Total for Check Number 24228:				0.00	168.00
24229	00369	CAROLE TRIANTAFILLOS	12/21/2023		
	JAN2024_369	CALPERS RETIREE			118.00
					<hr/>
Total for Check Number 24229:				0.00	118.00
24230	01075	MPRESS DIGITAL, INC	12/21/2023		
	122123	POSTAGE_PROP 218 MAILER			2,583.05
					<hr/>
Total for Check Number 24230:				0.00	2,583.05
					<hr/>
Total for 12/21/2023:				0.00	293,464.55
ACH	00055	AT&T	12/22/2023		
	120123_95559A	AT&T_ADMIN			2.01
	120123_95559B	AT&T_OPS			2,703.77
	120123_95559C	AT&T_WTP			617.59
	120123_95559D	AT&T_SEWER			268.22
					<hr/>
Total for this ACH Check for Vendor 00055:				0.00	3,591.59
					<hr/>
Total for 12/22/2023:				0.00	3,591.59
ACH	00599	WEX BANK	12/25/2023		
	93662621A	FUEL_FINANCE			1,178.54
	93662621B	FUEL_ENGINEERING			559.64
	93662621C	FUEL_OPS			4,857.06
	93662621D	FUEL_WTP			3,296.55
					<hr/>
Total for this ACH Check for Vendor 00599:				0.00	9,891.79
ACH	10217	UMPQUA BANK	12/25/2023		
	113023_7268A	AT HOME_OFFICE SUPPLIES			28.30
	113023_7268B	AT HOME_OFFICE SUPPLIES			28.30
	113023_7268C	GATEHOUSE_OPERATING SUPPLIES			47.35
	113023_7268D	MISC CHARGE			342.98

Check No	Vendor No Invoice No	Vendor Name Description	Check Date Reference	Void Checks	Check Amount
	113023_7268E	DAVIS INSTRUMENTS_WEATHER STATION			220.00
	113023_7268F	DAVIS INSTRUMENTS_WEATHER STATION			180.00
	113023_7268G	EMPIRE GRILL_FEMA TOUR #1960			65.00
	113023_7268H	JOHNNIES_FEMA TOUR #1960			14.38
	113023_7268I	MAILCHIMP_MARKETING			80.00
	113023_7268J	HIRERIGHT_BACKGROUND CHECK			49.00
	113023_7268K	MONTHLY ZOOM CHARGES			327.90
	113023_7268L	OFFICE DEPOT_OFFICE SUPPLIES			41.55
	113023_7268M	CAR WASH_VE#335_WO#94			104.99
	113023_7268N	INDEED_ADVERTISING			164.80
		Total for this ACH Check for Vendor 10217:		0.00	1,694.55
		Total for 12/25/2023:		0.00	11,586.34
ACH	00687 120523_8730	AT&T U-VERSE AT&T UVERSE_13057 HWY 9	12/27/2023		101.65
		Total for this ACH Check for Vendor 00687:		0.00	101.65
ACH	10421 43737582	FIRST-CITIZENS BANK & TRUST CO 5 YR LEASE_ADMIN COPIER	12/27/2023		253.45
		Total for this ACH Check for Vendor 10421:		0.00	253.45
ACH	10005 6748675	MISSIONSQUARE RETIREMENT PAY PERIOD ENDING 12/13/23	12/27/2023		4,563.85
		Total for this ACH Check for Vendor 10005:		0.00	4,563.85
		Total for 12/27/2023:		0.00	4,918.95
ACH	00569 3106398577	PURCHASE POWER QTRLY MAIL MACHINE LEASE	12/28/2023		462.87
		Total for this ACH Check for Vendor 00569:		0.00	462.87
ACH	00687 120623_6881	AT&T U-VERSE UVERSE_MANANA WOODS	12/28/2023		117.70
		Total for this ACH Check for Vendor 00687:		0.00	117.70
		Total for 12/28/2023:		0.00	580.57
ACH	10421 43750549	FIRST-CITIZENS BANK & TRUST CO 4 YR LEASE_KIRBY COPIER	12/29/2023		159.97
		Total for this ACH Check for Vendor 10421:		0.00	159.97
		Total for 12/29/2023:		0.00	159.97
ACH	00687 120823_2484	AT&T U-VERSE UVERSE_ADMIN FAX LINE	12/30/2023		110.85
		Total for this ACH Check for Vendor 00687:		0.00	110.85

Check No	Vendor No Invoice No	Vendor Name Description	Check Date Reference	Void Checks	Check Amount
ACH	00687 120723_2018	AT&T U-VERSE UVERSE_345 QUAIL	12/30/2023		107.00
		Total for this ACH Check for Vendor 00687:		0.00	107.00
		Total for 12/30/2023:		0.00	217.85
ACH	00313	MET LIFE	01/01/2024		
	121423_313A	DENTAL_ADMIN			329.96
	121423_313B	DISABILITY_ADMIN			86.12
	121423_313C	LIFE INS_ADMIN			33.30
	121423_313D	DENTAL_FINANCE			994.99
	121423_313E	DISABILITY_FINANCE			244.46
	121423_313F	LIFE INS_FINANCE			124.88
	121423_313G	DENTAL_ENG			539.00
	121423_313H	DISABILITY_ENG			184.92
	121423_313I	LIFE INS_ENG			66.60
	121423_313J	DENTAL_OPS			1,652.80
	121423_313K	DISABILITY_OPS			300.53
	121423_313L	LIFE INS_OPS			159.84
	121423_313M	DENTAL_ENVIRON			195.21
	121423_313N	DISABILITY_ENVIRON			124.68
	121423_313O	LIFE INS_ENVIRON			49.95
	121423_313P	DENTAL_WTP			1,436.89
	121423_313Q	DISABILITY_WTP			285.96
	121423_313R	LIFE INS_WTP			139.86
		Total for this ACH Check for Vendor 00313:		0.00	6,949.95
ACH	00399	VISION SERVICE PLAN - (CA)	01/01/2024		
	819475264A	VISION_ADMIN			50.72
	819475264B	VISION_FINANCE			150.34
	819475264C	VISION_ENG			69.20
	819475264D	VISION_OPS			247.12
	819475264E	VISION_ENVIRON			22.28
	819475264F	VISION_WTP			210.22
		Total for this ACH Check for Vendor 00399:		0.00	749.88
ACH	00545	AFLAC	01/01/2024		
	263042	2023 INSURANCE PREMIUMS			122.21
		Total for this ACH Check for Vendor 00545:		0.00	122.21
		Total for 1/1/2024:		0.00	7,822.04
ACH	00178	CALPERS	01/03/2024		
	JAN2024A	CALPERS_ADMIN			3,292.54
	JAN2024B	CALPERS_FINANCE			14,891.30
	JAN2024C	CALPERS_ENG			7,967.88
	JAN2024D	CALPERS_OPS			23,716.47
	JAN2024E	CALPERS_ENVIRON			2,042.82
	JAN2024F	CALPERS_RETIREEES			1,570.00
	JAN2024G	CALPERS_WTP			18,888.71
	JAN2024H	CALPERS_ADMIN FEE			259.10
	JAN2024I	CALPERS_DEPENDENTS			2,167.00

Check No	Vendor No Invoice No	Vendor Name Description	Check Date Reference	Void Checks	Check Amount
			Total for this ACH Check for Vendor 00178:	0.00	74,795.82
ACH	10207 120723_7861A 120723_7861B	CITI CARDS_COSTCO CENTRAL COAST WILDS_WO#1738 COSTCO_OFFICE SUPPLIES	01/03/2024		247.62 75.98
			Total for this ACH Check for Vendor 10207:	0.00	323.60
			Total for 1/3/2024:	0.00	75,119.42
ACH	00265 3357	COMMUNITY TELEVISION BOARD COVERAGE_NOVEMBER	01/04/2024		1,098.50
			Total for this ACH Check for Vendor 00265:	0.00	1,098.50
ACH	00450 3800038355 3800038656 3800038678	EUROFINS WATER ANALYSIS WATER ANALYSIS WATER ANALYSIS	01/04/2024		1,000.00 40.00 400.00
			Total for this ACH Check for Vendor 00450:	0.00	1,440.00
ACH	00493 015449	SPRINGBROOK HOLDING COMPANY I MONTHLY CIVICPAY TRANSACTION FEES	01/04/2024		2,330.00
			Total for this ACH Check for Vendor 00493:	0.00	2,330.00
ACH	00711 T998412A T998412B T998412C T998412D	CORE & MAIN LP CTS SDR9 POLYTUBE 250 PSI 1" 1X100 METER BOX LID B16 -BADGER ORION VALVE BOX LID G5 CAST IRON METER BOX B9	01/04/2024		827.31 7,092.06 897.06 2,643.89
			Total for this ACH Check for Vendor 00711:	0.00	11,460.32
24231	UB*01024	BART & JANE BISIO TRUST Refund Check 009700-000, 15650 FOREST HIL Refund Check 009700-000, 15650 FOREST HIL	01/04/2024		11.71 42.79
			Total for Check Number 24231:	0.00	54.50
24232	UB*01025	MRS RUBY BEATTIE Refund Check 012375-000, 255 ARDEN WAY Refund Check 012375-000, 255 ARDEN WAY	01/04/2024		16.83 61.50
			Total for Check Number 24232:	0.00	78.33
24233	10353 121723_241	SCOTT BRUCE UNIFORM	01/04/2024		292.07
			Total for Check Number 24233:	0.00	292.07
24234	10018 122923_098A 122923_098B	HOLLY HOSSACK REIMBURSEMENT_MILEAGE OFFICE SUPPLIES	01/04/2024		16.45 10.84
			Total for Check Number 24234:	0.00	27.29
24235	00539 1123SLV	MILLER MAXFIELD, INC OUTREACH SERVICES	01/04/2024		13,968.80

Check No	Vendor No Invoice No	Vendor Name Description	Check Date Reference	Void Checks	Check Amount
			Total for Check Number 24235:	0.00	13,968.80
24236	10348	POWERS FORESTRY LLC	01/04/2024		
	1152A	ANNUAL TANK MAINTENANCE			19,800.00
	1152B	ANNUAL TANK MAINTENANCE			19,800.00
			Total for Check Number 24236:	0.00	39,600.00
24237	00142	SAN LORENZO LUMBER	01/04/2024		
	61-0240802	SUPPLIES_LEAK REPAIR			5.36
			Total for Check Number 24237:	0.00	5.36
24238	00659	SANTA CRUZ FIRE EQUIP CO	01/04/2024		
	34064	FIRE EXTINGUISHER ANNUAL SRVC			2,241.41
			Total for Check Number 24238:	0.00	2,241.41
24239	00125	SCARBOROUGH LUMBER	01/04/2024		
	121132	SMALL TOOLS PARTS			26.97
	121133	SMALL TOOLS PARTS			35.60
	167701	OPERATING SUPPLIES			108.63
	167732	RETURN_OPERATING SUPPLIES			-109.73
	167929	OPERATING SUPPLIES			234.67
	416862	SMALL TOOLS PARTS			43.14
	416925	OPERATING SUPPLIES			22.30
	416978	OPERATING SUPPLIES			132.70
	417075	OPERATING SUPPLIES			34.07
	417198	OPERATING SUPPLIES			83.13
	417304	OPERATING SUPPLIES			73.35
	417427	OPERATING SUPPLIES			13.57
	417587	OPERATING SUPPLIES			30.20
	417693	SMALL TOOL PARTS			235.10
	417884	OPERATING SUPPLIES			29.13
	417918	SUPPLIES_SERVICE REPAIR			41.53
	417959	OPERATING SUPPLIES			140.44
	417960	SMALL TOOLS			89.75
	418012	OPERATING SUPPLIES			23.28
	418044	OPERATING SUPPLIES			17.24
	418047	OPERATING SUPPLIES			16.14
	449189	OPERATING SUPPLIES			21.72
	449197	LAB SUPPLIES			13.00
	6137	OPERATING SUPPLIES			32.69
	6138	TOOL REPAIR			39.96
	6142	SMALL TOOLS PARTS			69.03
	6157.0	OPERATING SUPPLIES			39.92
	6174	SMALL TOOLS			51.78
	627411	OPERATING SUPPLIES			33.47
	627416	OPERATING SUPPLIES			43.14
	627418	OPERATING SUPPLIES			12.93
	627422	OPERATING SUPPLIES			85.23
	627428	SMALL TOOLS PARTS			28.05
	627485	OPERATING SUPPLIES			21.57
	627515	OPERATING SUPPLIES			15.86
	627575	OPERATING SUPPLIES			12.61
	627604	OPERATING SUPPLIES			26.87
	627691	OFFICE SUPPLIES			100.96
	627887	OPERATING SUPPLIES			14.12
	627898	OPERATING SUPPLIES			5.82
	627904	OPERATING SUPPLIES			4.84

Check No	Vendor No Invoice No	Vendor Name Description	Check Date Reference	Void Checks	Check Amount
	627968	OPERATING SUPPLIES			41.15
	627970	OPERATING SUPPLIES			50.37
	G53749	OPERATING SUPPLIES			21.37
					<hr/>
				Total for Check Number 24239:	0.00 2,107.67
24240	00047	SOIL CONTROL LAB	01/04/2024		
	3120252	WATER ANALYSIS			49.00
	3120254	WATER ANALYSIS			196.00
					<hr/>
				Total for Check Number 24240:	0.00 245.00
24241	10406	SYBLON REID	01/04/2024		
	5_103123	FALL CREEK FISH LADDER_WO#1738			299,012.50
					<hr/>
				Total for Check Number 24241:	0.00 299,012.50
24242	10422	ROBERT J. CRAIG	01/04/2024		
	23077	SURVEY_LOST ACRE TANK SITE			3,900.00
					<hr/>
				Total for Check Number 24242:	0.00 3,900.00
					<hr/>
				Total for 1/4/2024:	0.00 377,861.75
ACH	00011	VERIZON WIRELESS	01/05/2024		
	9951712571A	CELL PHONE_ADMIN			664.58
	9951712571B	CELL PHONE_FINANCE			78.84
	9951712571C	CELL PHONE_ENG			159.83
	9951712571D	CELL PHONE_OPS			292.24
	9951712571E	CELL PHONE_ENVIRON			330.66
	9951712571F	CELL PHONE_WTP			705.45
	9951712572A	CELLULAR_ADMIN			19.77
	9951712572B	CELLULAR_FINANCE			46.57
	9951712572C	CELLULAR_OPS			468.95
	9951712572D	CELLULAR_WTP			139.70
					<hr/>
				Total for this ACH Check for Vendor 00011:	0.00 2,906.59
					<hr/>
				Total for 1/5/2024:	0.00 2,906.59
ACH	00309	AT&T IP SERVICES	01/06/2024		
	0551604806	AT&T_KIRBY			346.18
	1827535808A	OFFICE AT HAND_ADMIN			112.02
	1827535808B	OFFICE AT HAND_FINANCE			298.72
	1827535808C	OFFICE AT HAND_ENG			149.36
	1827535808D	OFFICE AT HAND_OPS			373.40
	1827535808E	OFFICE AT HAND_ENVIRON			37.33
	8462474805	AT&T_13060 CENTRAL			1,154.51
					<hr/>
				Total for this ACH Check for Vendor 00309:	0.00 2,471.52
					<hr/>
				Total for 1/6/2024:	0.00 2,471.52
ACH	00096	AWWA	01/09/2024		
	SO117768	2024 DUES_#36424			2,594.00

Check No	Vendor No Invoice No	Vendor Name Description	Check Date Reference	Void Checks	Check Amount
			Total for this ACH Check for Vendor 00096:	0.00	2,594.00
			Total for 1/9/2024:	0.00	2,594.00
ACH	00309	AT&T IP SERVICES	01/10/2024		
	8048984806A	IP SERVICES_ADMIN			268.37
	8048984806B	IP SERVICES_OPS			268.37
	8048984806C	IP SERVICES_WTP			268.37
			Total for this ACH Check for Vendor 00309:	0.00	805.11
ACH	01050	COLONIAL LIFE	01/10/2024		
	43777351213362	2023 INSURANCE PREMIUMS			389.82
			Total for this ACH Check for Vendor 01050:	0.00	389.82
			Total for 1/10/2024:	0.00	1,194.93
ACH	00141	B & B SMALL ENGINE	01/11/2024		
	536342	TOOL REPAIR			288.18
			Total for this ACH Check for Vendor 00141:	0.00	288.18
ACH	00145	BATTERIES PLUS	01/11/2024		
	P68593036	PARTS_VE#242_WO#1699			289.48
			Total for this ACH Check for Vendor 00145:	0.00	289.48
ACH	00164	FIRST ALARM	01/11/2024		
	791945A	ALARM SERVICES			696.63
	791945B	ALARM SERVICES			199.35
	794352A	ALARM SERVICES			258.63
	794352B	ALARM SERVICES			406.50
	794352C	ALARM SERVICES			605.07
			Total for this ACH Check for Vendor 00164:	0.00	2,166.18
ACH	00450	EUROFINS	01/11/2024		
	3800039505	WATER ANALYSIS			700.00
			Total for this ACH Check for Vendor 00450:	0.00	700.00
ACH	00505	DELL MARKETING LP	01/11/2024		
	10716728950	DELL MARKETING QUOTE #3000169245248			1,367.51
			Total for this ACH Check for Vendor 00505:	0.00	1,367.51
ACH	00711	CORE & MAIN LP	01/11/2024		
	T276761	1/2 GALV ST 90			10.06
	T388464-ADJ	INVOICE ADJUSTMENT			-0.02
	T998409A	GATE VALVE 1"			247.04
	T998409B	NIPPLE GALV 1" X 6"			29.04
	T998409C	BUSHING GALV 1-1/4" X 3/4"			7.91
	T998409D	NIPPLE GALV 2" X 3-1/2"			37.31
	T998409E	NIPPLE GALV 3/4" X 0"			9.16
	T998409F	NIPPLE GALV 2" X 5-1/2"			53.33
	T998409G	COPR-PIPE FEM 1"			320.13
	T998409H	REPAIR CLAMP 3/4" X 3"			75.43

Check No	Vendor No Invoice No	Vendor Name Description	Check Date Reference	Void Checks	Check Amount
T998409I		ELL 90 STREET GALV 3/4"			11.68
T998409J		TAPE CALPICO 2" (10MIL)			144.66
T998409K		NIPPLE GALV 3/4" X 2"			8.31
T998409L		FULL CIRCLE 3/4-3 REDI-CLP 244			31.16
T998409M		ELL 90 GALV 2"			100.50
T998409N		4" NUT & BOLT SET PLATED 150#			76.78
T998409O		UNION GALV 2"			80.75
T998409P		ELL 90 STREET GALV 2"			80.31
T998409Q		NIPPLE GALV 1" X 2-1/2"			13.28
T998409R		NIPPLE GALV 3/4" X 3"			10.68
T998409S		UNION GALV 3/4"			57.29
T998409T		COMPRESSION COUPLING 3/4" G/T			290.49
T998409U		FULL CIRCLE 1-1/2-3 REDI-CL244			173.58
T998409V		NIPPLE GALV 2" X 3"			42.29
T998409W		NIPPLE GALV 2" X 2-1/2"			4.23
T998409X		BLUE PAINT WATERBASE #3620			152.27
T998409Y		GATE VALVE 2"			885.52
Total for this ACH Check for Vendor 00711:				0.00	2,953.17
ACH	10025	BADGER METER, INC	01/11/2024		
	1625235A	METER 2" BADGER MODEL 170			813.15
	1625235B	METER 1 1/2" BADGER MODEL 120			1,177.23
Total for this ACH Check for Vendor 10025:				0.00	1,990.38
ACH	10067	NBS	01/11/2024		
	202312-3830	QUARTERLY FEES			1,915.00
Total for this ACH Check for Vendor 10067:				0.00	1,915.00
ACH	10246	OVISS LABS INCORPORATED	01/11/2024		
	R-63537	DVR CLOUD SERVICE			257.24
Total for this ACH Check for Vendor 10246:				0.00	257.24
ACH	00055	AT&T	01/11/2024		
	121923_6570	AT&T_FELTON ACRES			68.26
Total for this ACH Check for Vendor 00055:				0.00	68.26
24243	10177	ANDERSON PACIFIC ENGINEERING	01/11/2024		
	8_111723	ALTA VIA PIPELINE REPLACEMENT_#1921			135,581.81
Total for Check Number 24243:				0.00	135,581.81
24244	00342	BRASS KEY LOCKSMITH	01/11/2024		
	958924	KEYS_VE#749_WO#3034			35.67
	958929	KEYS_VE#211_WO#112			20.71
Total for Check Number 24244:				0.00	56.38
24245	00703	DATAFLOW BUSINESS SYSTEMS, INC	01/11/2024		
	377365	PRINTER SERVICES			287.74
	377409	PRINTER SERVICES			52.56
	377965	PRINTER SERVICES			54.53
Total for Check Number 24245:				0.00	394.83
24246	00076	ERNIE'S AUTO CENTER	01/11/2024		
	971099	OPERATING SUPPLIES			20.66

Check No	Vendor No Invoice No	Vendor Name Description	Check Date Reference	Void Checks	Check Amount
			Total for Check Number 24246:	0.00	20.66
24247	00343	ERNIE'S SERVICE CENTER	01/11/2024		
	114124	SERVICE_VE#480_WO#98			1,509.74
	114279	SERVICE_VE#236_WO#1205			105.62
	114445	SERVICE_VE#181_WO#111			276.52
			Total for Check Number 24247:	0.00	1,891.88
24248	00256	JESSE GUIVER	01/11/2024		
	010824_206	UNIFORM			151.76
			Total for Check Number 24248:	0.00	151.76
24249	00550	HACH COMPANY	01/11/2024		
	13857632	WT OPERATING LAB SUPPLIES			905.90
			Total for Check Number 24249:	0.00	905.90
24250	10432	CHRIS & KIM JORGENSEN	01/11/2024		
	CLAIM122323	CUSTOMER CLAIM			4,106.72
			Total for Check Number 24250:	0.00	4,106.72
24251	10410	JAKE LEONHART	01/11/2024		
	010424_258	REIMBURSMENT_OPERATING SUPPLIES			58.83
			Total for Check Number 24251:	0.00	58.83
24252	00296	MESITI-MILLER ENGINEERING,INC	01/11/2024		
	1023014	FISH LADDER_CONST MGMT_WO#1738			29,653.77
	1123004	FISH LADDER_CONST MGMT_WO#1738			23,318.32
			Total for Check Number 24252:	0.00	52,972.09
24253	00640	MONTEREY BAY AIR RESOURCES	01/11/2024		
	936-112923A	GENERATOR PERMITS			4,144.00
	936-112923B	GENERATOR PERMITS			2,453.00
			Total for Check Number 24253:	0.00	6,597.00
24254	00283	MOUNTAIN MECHANICS	01/11/2024		
	0015517	REPAIR_VE#309_WO#92			4,070.29
			Total for Check Number 24254:	0.00	4,070.29
24255	00775	NORTHERN SAFETY CO.,INC.	01/11/2024		
	905915924	SAFETY EQUIPMENT			363.55
	905931656	SAFETY EQUIPMENT			110.41
			Total for Check Number 24255:	0.00	473.96
24256	00410	ANDI O'NEAL	01/11/2024		
	122923_093	REIMBURSMENT_OFFICE SUPPLIES			72.99
			Total for Check Number 24256:	0.00	72.99
24257	10214	MIKE PODLECH	01/11/2024		
	2514	CONJUCTIVE USE PLAN_FY2223			1,260.00
			Total for Check Number 24257:	0.00	1,260.00

Check No	Vendor No Invoice No	Vendor Name Description	Check Date Reference	Void Checks	Check Amount
24258	10151 138	OSCAR RODAS JOHNSON BLDG MAINT	01/11/2024		250.00
Total for Check Number 24258:				0.00	250.00
24259	00642 VIII	STEVEN M.BUTLER,R.P.F. WATERSHED MAINTENANCE	01/11/2024		2,004.05
Total for Check Number 24259:				0.00	2,004.05
24260	00722 WD-0259346 WD-0259419	SWRCB - ELAP ANNUAL PERMIT_ID#34418WQ07 ANNUAL PERMIT_ID#34420WQ02	01/11/2024		399.00 399.00
Total for Check Number 24260:				0.00	798.00
24261	10406 6_113023	SYBLON REID FALL CREEK FISH LADDER_WO#1738	01/11/2024		102,837.50
Total for Check Number 24261:				0.00	102,837.50
24262	00721 4079372	UNITED SITE SVCS.,INC SANITARY SERVICES	01/11/2024		330.24
Total for Check Number 24262:				0.00	330.24
24263	10407 49104 49105 49106	WHITE BRENNER LLP LEGAL SERVICES LEGAL SERVICES_BB/FS_#2517 LEGAL SERVICES_OSHA	01/11/2024		7,239.80 1,177.50 4.80
Total for Check Number 24263:				0.00	8,422.10
24264	10433 CLAIM121823	WESLEY WOODWORTH CUSTOMER CLAIM	01/11/2024		1,840.00
Total for Check Number 24264:				0.00	1,840.00
Total for 1/11/2024:				0.00	337,092.39
ACH	00944 50064	PDNC, INC. DECEMBER_JANUARY_CLOUD SRVCS	01/13/2024		1,448.07
Total for this ACH Check for Vendor 00944:				0.00	1,448.07
Total for 1/13/2024:				0.00	1,448.07
ACH	00788 122023_6346A 122023_6346B 122023_6346C	COMCAST COMCAST_ADMIN COMCAST_WTP COMCAST_OPS	01/14/2024		267.44 1,989.08 1,284.87
Total for this ACH Check for Vendor 00788:				0.00	3,541.39
Total for 1/14/2024:				0.00	3,541.39
ACH	00054 122823_40624A	PACIFIC GAS AND ELECTRIC PG&E_ADMIN	01/16/2024		853.93

Check No	Vendor No Invoice No	Vendor Name Description	Check Date Reference	Void Checks	Check Amount
	122823_40624B	PG&E_OPS			14,696.19
	122823_40624C	PG&E_WTP			30,118.01
	122823_40624D	PG&E_SEWER			244.21
Total for this ACH Check for Vendor 00054:				0.00	45,912.34
Total for 1/16/2024:				0.00	45,912.34
ACH	00080 2633259	GRANITE CONSTRUCTION CO SUPPLIES_BASE ROCK	01/18/2024		156.31
Total for this ACH Check for Vendor 00080:				0.00	156.31
ACH	00141 536701	B & B SMALL ENGINE SMALL TOOL REPAIR	01/18/2024		29.71
Total for this ACH Check for Vendor 00141:				0.00	29.71
ACH	00145 P68419068	BATTERIES PLUS OPERATING SUPPLIES	01/18/2024		398.06
Total for this ACH Check for Vendor 00145:				0.00	398.06
ACH	00147 9100842	EMERSON PROCESS MANAGEMENT SCADA TROUBLESHOOTING	01/18/2024		6,318.00
Total for this ACH Check for Vendor 00147:				0.00	6,318.00
ACH	00220 37623	BAY BUILDING JANITORIAL,INC MONTHLY ADMIN JANITORIAL	01/18/2024		606.66
Total for this ACH Check for Vendor 00220:				0.00	606.66
ACH	00268 13148 13149 13150	WATTS ON GEN SERVICE_SCENIC GEN SERVICE_ADMIN GEN SERVICE_OPS	01/18/2024		549.38 636.50 435.75
Total for this ACH Check for Vendor 00268:				0.00	1,621.63
ACH	00450 3800039976	EUROFINS WATER ANALYSIS	01/18/2024		120.00
Total for this ACH Check for Vendor 00450:				0.00	120.00
ACH	00566 1076812222023A 1076812222023B	SANTA CRUZ ANSWERING SERVICE ANSWERING SERVICE ANSWERING SERVICE	01/18/2024		429.08 429.08
Total for this ACH Check for Vendor 00566:				0.00	858.16
ACH	00711 U098491A U098491B U098491C U098491D U098491E U098491F U131125A U131125B	CORE & MAIN LP REPAIR CLAMP 1-1/4" X 3" REPAIR CLAMP 6OD" X 3" NIPPLE GALV 2" X 2-1/2" FULL CIRCLE 2.35-2.63 7.50" REPAIR CLAMP 1/2" X 3" FULL CIR 1-1/2" X 6" REDICL244 BELL REDCR GALV 1-1/2" X 1" NIPPLE GALV 3/4" X 3-1/2"	01/18/2024		71.26 21.33 25.38 345.64 80.15 273.94 31.65 6.98

Check No	Vendor No Invoice No	Vendor Name Description	Check Date Reference	Void Checks	Check Amount
			Total for this ACH Check for Vendor 00711:	0.00	856.33
ACH	10025 80146672	BADGER METER, INC MONTHLY BEACON SERVICES	01/18/2024		9,973.93
			Total for this ACH Check for Vendor 10025:	0.00	9,973.93
ACH	10245 1209130908	GOTO TECHNOLOGIES USA, INC. MONTHLY AUDIO SERVICE	01/18/2024		180.00
			Total for this ACH Check for Vendor 10245:	0.00	180.00
ACH	10308	SANDIS	01/18/2024		
	2310223	ENGINEERING SERVICES_BB/FS_#2517			2,000.00
	2310322	ENGINEERING SERVICES_BB/FS_#2517			2,875.00
	2310323	ENGINEERING SERVICES_BB/FS_#2517			1,755.50
	2310324	ENGINEERING SERVICES_BB/FS_#2517			10,635.15
	2310325	ENGINEERING SERVICES_BB/FS_#2517			300.00
	2310326	ENGINEERING SERVICES_BB/FS_#2517			427.50
	2311075	ENGINEERING SERVICES_BB/FS_#2517			1,875.75
	2311109	CONSTRUCTION MGMT_ALTA VIA #1921			152.44
	2311110	CONSTRUCTION MGMT_ALTA VIA #1921			21,850.63
	2311297A	2021 FEMA PIPELINE PROJECT #1923			227.50
	2311297B	2021 FEMA PIPELINE PROJECT #1953			227.50
	2311298A	2021 CIP PIPELINE #2180			203.00
	2311298B	2021 CIP PIPELINE #2181			203.00
	2311298C	2021 CIP PIPELINE #2182			203.00
	2311298D	2021 CIP PIPELINE #2183			203.00
	2311298E	2021 CIP PIPELINE #2184			203.00
			Total for this ACH Check for Vendor 10308:	0.00	43,341.97
24265	00057 DEC2023 NOV2023	AFSCME COUNCIL 57 UNION DUES_DECEMBER UNION DUES_NOVEMBER	01/18/2024		1,329.44 1,692.12
			Total for Check Number 24265:	0.00	3,021.56
24266	00729 3126653	ALPHA ANALYTICAL LABS WASTEWATER MONITORING	01/18/2024		1,535.00
			Total for Check Number 24266:	0.00	1,535.00
24267	10177 9_ALTAVIA	ANDERSON PACIFIC ENGINEERING ALTA VIA PIPELINE REPLACEMENT_#1921	01/18/2024		103,445.00
			Total for Check Number 24267:	0.00	103,445.00
24268	00162 000316443777	ANTHEM BLUE CROSS RETIREE MEDICAL	01/18/2024		465.37
			Total for Check Number 24268:	0.00	465.37
24269	00767 000314833832	ANTHEM BLUE CROSS MEDICARE_RETIREE	01/18/2024		100.60
			Total for Check Number 24269:	0.00	100.60
24270	10320 0098873	AQUA-METRIC SALES CO. SOFTWARE SUPPORT	01/18/2024		2,437.95

Check No	Vendor No Invoice No	Vendor Name Description	Check Date Reference	Void Checks	Check Amount
			Total for Check Number 24270:	0.00	2,437.95
24271	10113	BANK MIDWEST	01/18/2024		
	FEB2024_1011A	SOLAR LOAN_INTEREST			320.69
	FEB2024_1011B	SOLAR LOAN_PRINCIPAL			2,929.21
			Total for Check Number 24271:	0.00	3,249.90
24272	00750 123123	C.J. BROWN & COMPANY, CPAS AUDIT SERVICES FY2223	01/18/2024		3,675.00
			Total for Check Number 24272:	0.00	3,675.00
24273	00703 378737 379087	DATAFLOW BUSINESS SYSTEMS, INC PRINTER SERVICES PRINTER INK	01/18/2024		60.05 12.50
			Total for Check Number 24273:	0.00	72.55
24274	00037 113023_P63267A 113023_P63267B 46457	CO. OF SANTA CRUZ DEPT OF PUBLIC PERMITS PERMITS DUMP FEES	01/18/2024		153.34 153.34 796.30
			Total for Check Number 24274:	0.00	1,102.98
24275	00343 114096 114136 114207 114404 114466 114645	ERNIE'S SERVICE CENTER SMOG INSPECTION_VE#338_WO#95 SMOG INSPECTION_VE#249_WO#113 SMOG INSPECTION_VE#280_WO#116 SMOG INSPECTION_VE#275_WO#90 SMOG INSPECTION_VE#264_WO#115 SMOG INSPECTION_VE#249_WO#113	01/18/2024		44.78 44.78 46.73 44.78 44.78 98.42
			Total for Check Number 24275:	0.00	324.27
24276	00397 4791424	FERGUSON ENTERPRISES, INC OPERATING SUPPLIES	01/18/2024		22.69
			Total for Check Number 24276:	0.00	22.69
24277	00016 0007241673	GREENWASTE RECOVERY, INC MONTHLY DUMPSTER SERVICE	01/18/2024		558.10
			Total for Check Number 24277:	0.00	558.10
24278	10434 28570	HOGAN LAND SERVICES, INC ENGINEERING SRVCS	01/18/2024		3,607.50
			Total for Check Number 24278:	0.00	3,607.50
24279	00615 122823_8423	HOME DEPOT CREDIT SERVICES SMALL TOOLS	01/18/2024		233.26
			Total for Check Number 24279:	0.00	233.26
24280	00236 3142654809	IDEXX DISTRIBUTION CORP LAB SUPPLIES	01/18/2024		2,685.98
			Total for Check Number 24280:	0.00	2,685.98
24281	00058	IHWY	01/18/2024		

Check No	Vendor No Invoice No	Vendor Name Description	Check Date Reference	Void Checks	Check Amount
	07620	MONTHLY WEBHOSTING			25.00
			Total for Check Number 24281:	0.00	25.00
24282	00367 253769A 253769B	INFOSEND, INC POSTAGE FEES MAILING FEES	01/18/2024		2,830.73 996.41
			Total for Check Number 24282:	0.00	3,827.14
24283	00582 147357	OLIVE SPRINGS QUARRY SUPPLIES	01/18/2024		84.97
			Total for Check Number 24283:	0.00	84.97
24284	00142 60-0241171	SAN LORENZO LUMBER SAFETY EQUIPMENT	01/18/2024		78.46
			Total for Check Number 24284:	0.00	78.46
24285	00040 010924_1393475	SANTA CRUZ SENTINEL SUBSCRIPTION RENEWAL_2024	01/18/2024		56.36
			Total for Check Number 24285:	0.00	56.36
24286	00047 3120440 3120441	SOIL CONTROL LAB WATER ANALYSIS WATER ANALYSIS	01/18/2024		49.00 196.00
			Total for Check Number 24286:	0.00	245.00
			Total for 1/18/2024:	0.00	195,315.40
ACH	00055 010124_5559A 010124_5559B 010124_5559C 010124_5559D	AT&T AT&T_ADMIN AT&T_OPS AT&T_WTP AT&T_SEWER	01/23/2024		2.02 2,715.53 619.73 269.34
			Total for this ACH Check for Vendor 00055:	0.00	3,606.62
			Total for 1/23/2024:	0.00	3,606.62
ACH	10005 6047441	MISSIONSQUARE RETIREMENT PAY PERIOD ENDING 1/10/24	01/24/2024		5,487.44
			Total for this ACH Check for Vendor 10005:	0.00	5,487.44
			Total for 1/24/2024:	0.00	5,487.44
ACH	10423 16135	REGIONAL GOVERNMENT SERVICES FINANCE CONSULTANT	01/25/2024		5,925.00
			Total for this ACH Check for Vendor 10423:	0.00	5,925.00
ACH	00100 FEB2023_100	RICK ROGERS CALPERS_RETIREE	01/25/2024		118.00

Check No	Vendor No Invoice No	Vendor Name Description	Check Date Reference	Void Checks	Check Amount
			Total for this ACH Check for Vendor 00100:	0.00	118.00
ACH	00183 75007	SDRMA PROPERTY INSURANCE	01/25/2024		2,778.95
			Total for this ACH Check for Vendor 00183:	0.00	2,778.95
ACH	00268 13151	WATTS ON ZAYANTE BOOSTER SERVICE	01/25/2024		1,167.61
			Total for this ACH Check for Vendor 00268:	0.00	1,167.61
ACH	00273 30700473	CORELOGIC, INC. MONTHLY REALQUEST SERVICES	01/25/2024		103.00
			Total for this ACH Check for Vendor 00273:	0.00	103.00
ACH	10025 1627039 1627735	BADGER METER, INC METER 5/8" X 3/4" BADGER MODEL 25 METER 5/8" X 3/4" BADGER MODEL 25	01/25/2024		58,762.99 4,111.90
			Total for this ACH Check for Vendor 10025:	0.00	62,874.89
ACH	10295 102608 103419	PANORAMA ENVIRONMENTAL INC. ZAYANTE PIPELINE #2184 SURVEYS_ALTA VIA #1921	01/25/2024		1,442.50 8,007.78
			Total for this ACH Check for Vendor 10295:	0.00	9,450.28
ACH	10387 23-1007-8	CBEC, INC CONJUNCTIVE USE TECH SUPPORT #2614	01/25/2024		13,257.00
			Total for this ACH Check for Vendor 10387:	0.00	13,257.00
ACH	10397 2021CIP7A 2021CIP7B 2021CIP7C 2021CIP7D 2021CIP7E 2021CIP8.A 2021CIP8.B 2021CIP8.C 2021CIP8.D 2021CIP8.E LYONBIGSTEEL5A LYONBIGSTEEL5B LYONBIGSTEEL5C LYONBIGSTEEL6.A LYONBIGSTEEL6.B LYONBIGSTEEL6.C REDWOOD4	360PSM INC. CERTIFIED PAYROLL MONITORING #2180 CERTIFIED PAYROLL MONITORING #2181 CERTIFIED PAYROLL MONITORING #2182 CERTIFIED PAYROLL MONITORING #2183 CERTIFIED PAYROLL MONITORING #2184 CERTIFIED PAYROLL MONITORING WO#21 CERTIFIED PAYROLL MONITORING WO#21 CERTIFIED PAYROLL MONITORING WO#21 CERTIFIED PAYROLL MONITORING WO#21 CERTIFIED PAYROLL MONITORING WO#21 CERTIFIED PAYROLL MONITORING WO#21 CERTIFIED PAYROLL MONITORING_WO#1 CERTIFIED PAYROLL MONITORING_WO#3 CERTIFIED PAYROLL MONITORING_WO#1 CERTIFIED PAYROLL MONITORING_WO#1 CERTIFIED PAYROLL MONITORING_WO#3 CERTIFIED PAYROLL MONITORING_WO#1 LABOR COMPLIANCE WO#845	01/25/2024		759.62 759.62 759.63 759.63 759.63 373.37 373.37 373.38 373.38 373.38 1,115.84 1,115.83 1,115.83 493.54 493.54 493.55 386.87
			Total for this ACH Check for Vendor 10397:	0.00	10,880.01
ACH	10398 93811020704010A 93811020704010B 93811020704010C 93811020704010D 93811020704010E	JMB CONSTRUCTION, INC. 2021 CIP PIPELINE PROJECT #2180 2021 CIP PIPELINE PROJECT #2181 2021 CIP PIPELINE PROJECT #2182 2021 CIP PIPELINE PROJECT #2183 2021 CIP PIPELINE PROJECT #2184	01/25/2024		76,541.50 4,004.25 37,444.25 148,637.00 528,214.25

Check No	Vendor No Invoice No	Vendor Name Description	Check Date Reference	Void Checks	Check Amount
	93811020804010A	2021 CIP PIPELINE PROJECT #2180			59,243.80
	93811020804010B	2021 CIP PIPELINE PROJECT #2181			101,764.00
	93811020804010C	2021 CIP PIPELINE PROJECT #2183			2,506.50
	93811020804010D	2021 CIP PIPELINE PROJECT #2184			49,367.70
	PP#7_RETAIN#7A	2021 CIP PIPELINE RETENTION #2180			4,028.50
	PP#7_RETAIN#7B	2021 CIP PIPELINE RETENTION #2181			210.75
	PP#7_RETAIN#7C	2021 CIP PIPELINE RETENTION #2182			1,970.75
	PP#7_RETAIN#7D	2021 CIP PIPELINE RETENTION #2183			7,823.00
	PP#7_RETAIN#7E	2021 CIP PIPELINE RETENTION #2184			27,800.75
	PP#8_RETAIN#8A	2021 CIP PIPELINE RETENTION #2180			3,118.10
	PP#8_RETAIN#8B	2021 CIP PIPELINE RETENTION #2181			5,356.00
	PP#8_RETAIN#8C	2021 CIP PIPELINE RETENTION #2183			131.91
	PP#8_RETAIN#8D	2021 CIP PIPELINE RETENTION #2184			2,598.30
		Total for this ACH Check for Vendor 10398:		0.00	1,060,761.31
ACH	10005 6186851	MISSIONSQUARE RETIREMENT PAY PERIOD ENDING 12/27/23	01/25/2024		4,713.85
		Total for this ACH Check for Vendor 10005:		0.00	4,713.85
ACH	10217	UMPQUA BANK	01/25/2024		
	123123_7268A	AMAZON_OFFICE SUPPLIES			31.60
	123123_7268AA	MOUNTAIN MECHANICS_SRVC VE#309 W			1,745.64
	123123_7268B	DAVIS_WEATHER STATION			47.40
	123123_7268BB	CEQA TRAINING CLASS			432.00
	123123_7268C	AMAZON_OFFICE SUPPLIES			18.51
	123123_7268CC	PUBLIC SAFETY_SAFETY EQUIP			188.05
	123123_7268D	AMAZON_OFFICE SUPPLIES			65.39
	123123_7268DD	SANTACRUZJOBS.COM_ADVERTISING			100.00
	123123_7268E.1	AMAZON_OFFICE SUPPLIES			74.42
	123123_7268E.2	AMAZON_OFFICE SUPPLIES			31.75
	123123_7268E.3	AMAZON_OFFICE SUPPLIES			31.75
	123123_7268E.4	AMAZON_OFFICE SUPPLIES			31.75
	123123_7268E.5	AMAZON_OFFICE SUPPLIES			31.75
	123123_7268E.6	AMAZON_OFFICE SUPPLIES			31.75
	123123_7268EE	TEXACO_FUEL			97.98
	123123_7268F	ERGO WORKS_OFFICE SUPPLIES			256.37
	123123_7268G	SALMONID CONFERENCE			50.00
	123123_7268H	SALMONID CONFERENCE			600.00
	123123_7268I	SALMONID CONFERENCE			640.00
	123123_7268J	INDEED_ADVERTISING			336.62
	123123_7268K	OTTERBOX_OFFICE SUPPLIES			58.08
	123123_7268L	STAPLES_OFFICE SUPPLIES			145.43
	123123_7268M	AMAZON_OFFICE SUPPLIES			202.73
	123123_7268N	AMAZON_OFFICE SUPPLIES			45.53
	123123_7268O.1	CARHARTT_UNIFORMS			2,000.00
	123123_7268O.2	CARHARTT_UNIFORMS			2,000.00
	123123_7268O.3	CARHARTT_UNIFORMS			468.12
	123123_7268P	AMAZON_OFFICE SUPPLIES			16.55
	123123_7268Q	STAPLES_OFFICE SUPPLIES			230.51
	123123_7268R	AMAZON_OFFICE SUPPLIES			33.01
	123123_7268S.1	CARHARTT_SAFETY UNIFORMS			1,500.00
	123123_7268S.2	CARHARTT_SAFETY UNIFORMS			1,500.00
	123123_7268S.3	CARHARTT_SAFETY UNIFORMS			694.26
	123123_7268T	AMAZON_OFFICE SUPPLIES			5.71
	123123_7268U	AMAZON_OFFICE SUPPLIES			217.25
	123123_7268V	AMAZON_OFFICE SUPPLIES			43.57
	123123_7268W	SCOTTS VALLEY CAR WASH_VE#121 WO#			61.99
	123123_7268X	AMAZON_OFFICE SUPPLIES			160.16

Check No	Vendor No Invoice No	Vendor Name Description	Check Date Reference	Void Checks	Check Amount
	123123_7268Y	AMAZON_OFFICE SUPPLIES			151.40
	123123_7268Z	AEP MEMBERSHIP			275.00
	123123_7269FF	MONTHLY ZOOM CHARGES			347.90
	123123_7269GG	AMAZON_OFFICE SUPPLIES			8.27
	123123_7269HH	AMAZON_OFFICE SUPPLIES			201.64
	123123_7269II	MAILCHIMP_MARKETING			92.00
	123123_7269JJ	AMAZON_OFFICE SUPPLIES			88.65
	123123_7269KK	INTEGRITY AUTO_VE#121 WO#84			265.00
	123123_7269LL	AMAZON_OFFICE SUPPLIES			141.68
	123123_7269MM	AMAZON_OFFICE SUPPLIES			25.60
		Total for this ACH Check for Vendor 10217:		0.00	15,822.77
24287	00565 FEB2024_565	DETLEF ADAM CALPERS_RETIREE	01/25/2024		118.00
		Total for Check Number 24287:		0.00	118.00
24288	00729 4013216	ALPHA ANALYTICAL LABS WASTEWATER MONITORING	01/25/2024		690.00
		Total for Check Number 24288:		0.00	690.00
24289	00034 FEB2024_034	DAVE BASLER CALPERS_RETIREE	01/25/2024		68.00
		Total for Check Number 24289:		0.00	68.00
24290	00099 FEB2024_099	JOEL BUSA CALPERS_RETIREE	01/25/2024		118.00
		Total for Check Number 24290:		0.00	118.00
24291	10405 2023090004	CASEY CONSTRUCTION, INC REDWOOD PARK PIPELINE WO#845	01/25/2024		92,568.95
		Total for Check Number 24291:		0.00	92,568.95
24292	00172 FEB2024_172	JOSEPH F. CONE CALPERS_RETIREE	01/25/2024		168.00
		Total for Check Number 24292:		0.00	168.00
24293	00703 379562 379563	DATAFLOW BUSINESS SYSTEMS, INC PRINTER SERVICES PRINTER SERVICES	01/25/2024		66.84 52.14
		Total for Check Number 24293:		0.00	118.98
24294	00760 28503	DYNAMIC PRESS BUSINESS CARDS	01/25/2024		71.94
		Total for Check Number 24294:		0.00	71.94
24295	00343 114746 115093	ERNIE'S SERVICE CENTER SERVICE_VE#230 WO#694 SERVICE_VE#244 WO#1700	01/25/2024		871.37 134.98
		Total for Check Number 24295:		0.00	1,006.35
24296	10103 012124_218	OCTAVIO FERNANDEZ UNIFORM	01/25/2024		384.08

Check No	Vendor No Invoice No	Vendor Name Description	Check Date Reference	Void Checks	Check Amount
			Total for Check Number 24296:	0.00	384.08
24297	00550	HACH COMPANY	01/25/2024		
	13864545	WT OPERATING LAB SUPPLIES			228.91
	13875828	OPERATING SUPPLIES			599.99
	13879195	WT OPERATING LAB SUPPLIES			1,321.08
			Total for Check Number 24297:	0.00	2,149.98
24298	00208	LEONARD KUHNLEIN	01/25/2024		
	FEB2024_208	CALPERS_RETIREE			118.00
			Total for Check Number 24298:	0.00	118.00
24299	UB*01027	SHIRLEY LEE	01/25/2024		
		Refund Check 014594-000, 178 MADRONA RI			0.97
		Refund Check 014594-000, 178 MADRONA RI			3.53
			Total for Check Number 24299:	0.00	4.50
24300	00296	MESITI-MILLER ENGINEERING,INC	01/25/2024		
	1223017	FISH LADDER_CONST MGMT_WO#1738			17,668.74
	1223018	FISH LADDER_CONST MGMT_WO#1738			858.00
			Total for Check Number 24300:	0.00	18,526.74
24301	UB*01026	NICHOLAS MITCHELL	01/25/2024		
		Refund Check 008714-000, 370 MANZANITA			25.32
		Refund Check 008714-000, 370 MANZANITA			58.90
		Refund Check 008714-000, 370 MANZANITA			16.12
			Total for Check Number 24301:	0.00	100.34
24302	00662	JAMES A. MUELLER	01/25/2024		
	FEB2024_992	CALPERS_RETIREE			43.00
			Total for Check Number 24302:	0.00	43.00
24303	00047	SOIL CONTROL LAB	01/25/2024		
	3120103	WATER ANALYSIS			78.00
	3120253	WATER ANALYSIS			78.00
	3120442	WATER ANALYSIS			78.00
	3120566	WATER ANALYSIS			196.00
	3120567	WATER ANALYSIS			49.00
	3120568	WATER ANALYSIS			78.00
	3120572	WATER ANALYSIS			552.00
	4010047	WATER ANALYSIS			196.00
	4010048	WATER ANALYSIS			49.00
	4010173	WATER ANALYSIS			196.00
	4010174	WATER ANALYSIS			49.00
			Total for Check Number 24303:	0.00	1,599.00
24304	00093	JOHN TREGEMBO	01/25/2024		
	FEB2024_093	CALPERS_RETIREE			168.00
			Total for Check Number 24304:	0.00	168.00
24305	00369	CAROLE TRIANTAFILLOS	01/25/2024		
	FEB2024_369	CALPERS_RETIREE			118.00

Check No	Vendor No Invoice No	Vendor Name Description	Check Date Reference	Void Checks	Check Amount
			Total for Check Number 24305:	0.00	118.00
			Total for 1/25/2024:	0.00	1,305,992.53
ACH	00599	WEX BANK	01/26/2024		
	94220642A	FUEL_ADMIN			60.16
	94220642B	FUEL_FINANCE			861.08
	94220642C	FUEL_ENGINEERING			414.41
	94220642D	FUEL_OPS			4,835.07
	94220642E	FUEL_WTP			3,353.22
		Total for this ACH Check for Vendor 00599:		0.00	9,523.94
		Total for 1/26/2024:		0.00	9,523.94
ACH	10421	FIRST-CITIZENS BANK & TRUST CO	01/27/2024		
	43937574	5 YR LEASE_ADMIN COPIER			253.45
		Total for this ACH Check for Vendor 10421:		0.00	253.45
		Total for 1/27/2024:		0.00	253.45
ACH	00687	AT&T U-VERSE	01/28/2024		
	010524_8730	UVERSE_13057 HWY 9			101.65
		Total for this ACH Check for Vendor 00687:		0.00	101.65
		Total for 1/28/2024:		0.00	101.65
ACH	00687	AT&T U-VERSE	01/29/2024		
	010624_6881	UVERSE_MANANA WOODS			117.70
		Total for this ACH Check for Vendor 00687:		0.00	117.70
ACH	10421	FIRST-CITIZENS BANK & TRUST CO	01/29/2024		
	43946185	4 YR LEASE_KIRBY COPIER			159.97
		Total for this ACH Check for Vendor 10421:		0.00	159.97
		Total for 1/29/2024:		0.00	277.67
ACH	00687	AT&T U-VERSE	01/30/2024		
	010724_2018	UVERSE_345 QUAIL			107.00
	010824_2484	UVERSE_ADMIN FAX LINE			110.88
		Total for this ACH Check for Vendor 00687:		0.00	217.88
		Total for 1/30/2024:		0.00	217.88

Check No	Vendor No Invoice No	Vendor Name Description	Check Date Reference	Void Checks	Check Amount
Report Total (422 checks):				0.00	6,845,839.99

EFT & DIRECT CHECK TRANSACTIONS

Nov-23



Date	Check No	Vendor	Description	Amount
11/2/2023	EFT	BLUE FIN	BANK FEES	\$ 6,286.85
11/16/2023	EFT	T-TECH	BANK FEES	\$ 1,429.56
11/1/2023	EFT	PAYCHEX	ADMIN & DELIVERY FEES	\$ 309.95
11/1/2023	EFT	PAYCHEX	PAYROLL	\$ 158,986.81
11/1/2023	DIRECT CHECK	PAYCHEX	PAYROLL	\$ 8,786.32
11/15/2023	EFT	PAYCHEX	ADMIN & DELIVERY FEES	\$ 320.90
11/15/2023	EFT	PAYCHEX	PAYROLL	\$ 125,703.62
11/15/2023	DIRECT CHECK	PAYCHEX	PAYROLL	\$ 7,724.24
11/29/2023	EFT	PAYCHEX	ADMIN & DELIVERY FEES	\$ 302.65
11/29/2023	EFT	PAYCHEX	PAYROLL	\$ 127,555.42
11/29/2023	DIRECT CHECK	PAYCHEX	PAYROLL	\$ 8,815.66
11/10/2023	EFT	PAYCHEX	PAYCHEX INVOICE	\$ 407.40
11/20/2023	EFT	PAYCHEX	PAYCHEX FLEX TIME FEE	\$ 277.35
11/1/2023	EFT	CALPERS	CALPERS 11/01/23 PR	\$ 22,790.61
11/15/2023	EFT	CALPERS	CALPERS 11/15/23 PR	\$ 22,390.78
11/29/2023	EFT	CALPERS	CALPERS 11/29/23 PR	\$ 21,805.52
11/30/2023	EFT	FSA	NOVEMBER FSA REIMBURSEMENTS	\$ 4,342.04
TOTAL EFT TRANSACTIONS				\$ 518,235.68

EFT & DIRECT CHECK TRANSACTIONS

Dec-23



Date	Check No	Vendor	Description	Amount
12/4/2023	EFT	BLUE FIN	BANK FEES	\$ 7,777.20
12/16/2023	EFT	T-TECH	BANK FEES	\$ 1,270.96
12/13/2023	EFT	PAYCHEX	ADMIN & DELIVERY FEES	\$ 306.30
12/13/2023	EFT	PAYCHEX	PAYROLL	\$ 133,239.02
12/13/2023	DIRECT CHECK	PAYCHEX	PAYROLL	\$ 9,829.44
12/27/2023	EFT	PAYCHEX	ADMIN & DELIVERY FEES	\$ 324.55
12/27/2023	EFT	PAYCHEX	PAYROLL	\$ 133,183.07
12/27/2023	DIRECT CHECK	PAYCHEX	PAYROLL	\$ 8,045.89
12/15/2023	EFT	PAYCHEX	PAYCHEX INVOICE	\$ 410.55
12/20/2023	EFT	PAYCHEX	PAYCHEX FLEX TIME FEE	\$ 283.80
12/18/2023	EFT	CALPERS	CALPERS 11/29/23 PR	\$ 22,429.71
12/27/2023	EFT	CALPERS	CALPERS 12/13/23 PR	\$ 22,697.81
12/31/2023	EFT	FSA	DECEMBER FSA REIMBURSEMENTS	\$ 1,976.07
TOTAL EFT TRANSACTIONS				\$ 341,774.37

EFT & DIRECT CHECK TRANSACTIONS

Jan-24



Date	Check No	Vendor	Description	Amount
1/31/2024	EFT	BLUE FIN	BANK FEES	\$ 5,885.53
1/17/2024	EFT	T-TECH	BANK FEES	\$ 1,287.51
1/10/2024	EFT	PAYCHEX	ADMIN & DELIVERY FEES	\$ 811.80
1/10/2024	EFT	PAYCHEX	PAYROLL	\$ 137,958.70
1/10/2024	DIRECT CHECK	PAYCHEX	PAYROLL	\$ 8,713.81
1/24/2024	EFT	PAYCHEX	ADMIN & DELIVERY FEES	\$ 328.20
1/24/2024	EFT	PAYCHEX	PAYROLL	\$ 140,912.31
1/24/2024	DIRECT CHECK	PAYCHEX	PAYROLL	\$ 8,789.21
1/12/2024	EFT	PAYCHEX	PAYCHEX INVOICE	\$ 410.55
1/20/2024	EFT	PAYCHEX	PAYCHEX FLEX TIME FEE	\$ 277.35
1/18/2024	EFT	CALPERS	CALPERS 12/27/23 PR	\$ 23,636.33
1/30/2024	EFT	CALPERS	CALPERS 1/10/24 PR	\$ 23,673.94
1/31/2024	EFT	FSA	JANUARY FSA REIMBURSEMENTS	\$ 1,254.51
TOTAL EFT TRANSACTIONS				\$ 353,939.75

Fall Creek Intake January 2024

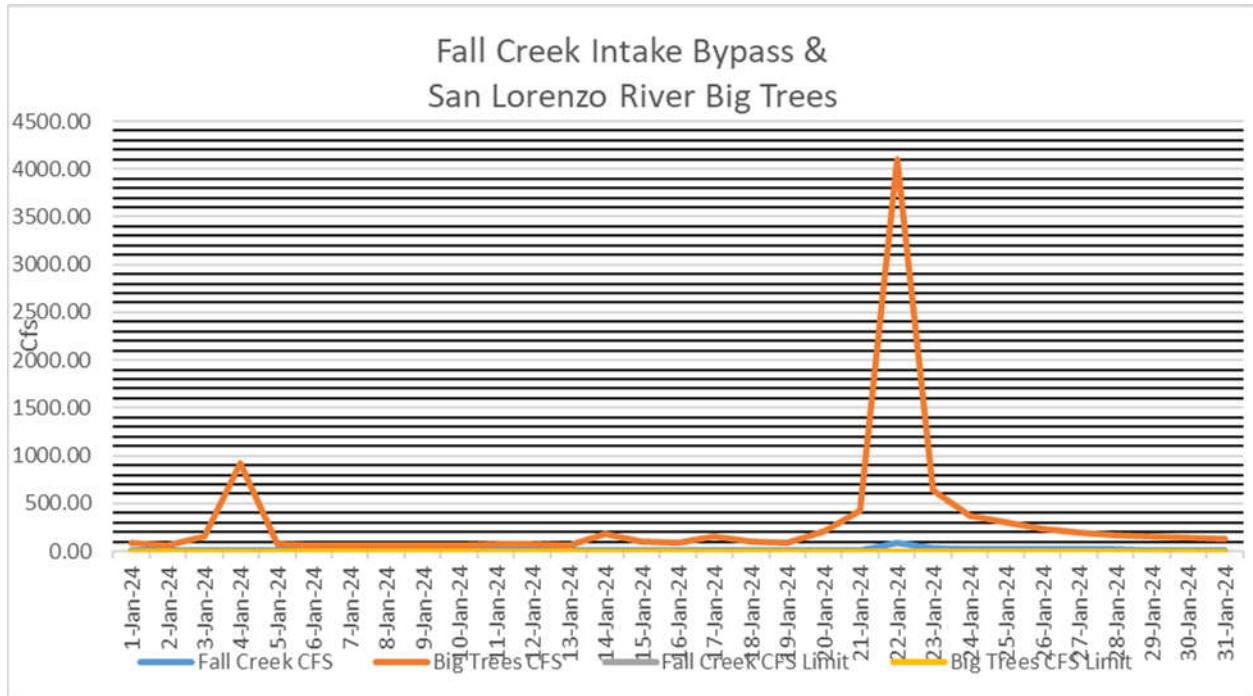

Normal Rainfall Fall Creek Intake Bypass Requirements

April 1 through October 31 1.0 cubic feet per second

November 1 through March 31 1.5 cubic feet per second

Dry Conditions Fall Creek Intake Bypass Requirements

April 1 through October 31 0.5 cubic feet per second

November 1 through March 31 0.75 cubic feet per second

Number of Days in month 0.75 cfs or below, ZERO days

San Lorenzo River USGS Big Trees Flow Requirements

September 11 cubic feet per second

October 26 cubic feet per second

November 1 through May 31 21 cubic feet per second

June - August No Requirements

Fall Creek Intake January 2024

For the protection of fish and wildlife, during the period: (a) April 1 through October 31 bypass a minimum of 0.5 cfs; (b) November 1 through March 31 bypass a minimum of 1.5 cfs past the Fall Creek point of diversion. The natural streamflow shall be bypassed whenever it is less than 1.5 cfs; provided, however, that during a dry year, the bypass requirement shall be reduced from 1.5 to 0.75 cfs. A dry year is defined on a monthly basis of cumulative runoff beginning October 1 of each season in the San Lorenzo River at the USGS gage at Big Trees. These runoff figures are based on approximately 50 percent of normal runoff as the dividing level between normal and dry year runoff and are as follows:

- November 1 for the month of October 500 af
- December 1 for October-November, inclusive 1,500 af
- January 1 for October-December, inclusive 5,000 af
- February 1 for October-January, inclusive 12,500 af
- March 1 for October-February, inclusive 26,500 af

Fall Creek Weir Measurement

Agenda: 4.4.24

Item: 12.4

Month:	January	Year:	2024	Big Trees > 26,500 Acre-ft Oct-Feb Normal Year				Big Trees <26,500 Acre-ft Oct-Feb Dry Year			
				<input checked="" type="checkbox"/>				<input type="checkbox"/>			
Date	Time	Initials	Pump #	Fall Cr. GPM into Kirby plant	Weir Board Height (inches)	Fall Creek Bypass (CFS)	Big Trees Bypass (CFS)	Rainfall (Felton gauge)	Met Fall Cr, Bypass Requirement: Normal Year April 1 - Oct 31 1.0 cfs; Nov 1 - March 31 1.5 cfs Dry Year April 1- Oct 31 0.5 cfs Nov. 1 - March 31 0.75 cfs (yes/no)	Met Big Trees Requirement Nov-May 20cfs Sept 10 cfs Oct 25 cfs (yes/no)	Notes
1	1230	BM	TEMP	385	25	3.390	82.30	0	YES	YES	
2	1400	BM	TEMP	393	25	2.960	64.70	0	YES	YES	
3	645	JD	TEMP	OFF	25	4.610	159.00	1.57	YES	YES	
4	1330	DM	TEMP	212	25	3.980	927.00	0.04	YES	YES	
5	1350	DM	1	440	25	5.030	72.70	0.02	YES	YES	
6	820	KM	1	399	25	3.842	61.70	0	YES	YES	
7	700	KM	1	320	25	3.882	66.30	0.35	YES	YES	
8	820	DM	1	252	25	3.690	55.80	0.01	YES	YES	
9	745	DM	1	395	25	3.210	55.40	0	YES	YES	
10	715	DM	1	423	25	3.110	55.40	0.12	YES	YES	
11	720	DM	1	344	25	3.680	72.10	0.51	YES	YES	
12	640	JD	1	392	25	3.280	71.30	0.01	YES	YES	
13	1330	BM	1	440	25	3.020	56.20	0.02	YES	YES	
14	1420	BM	1	407	25	6.710	180.00	1.46	YES	YES	
15	1240	BM	1	400	25	5.290	107.00	0	YES	YES	
16	700	JD	1	403	25	4.780	86.50	0.01	YES	YES	
17	725	DM	1	403	25	6.150	149.00	1.2	YES	YES	
18	630	JD	1	420	25	5.100	97.00	0.01	YES	YES	
19	645	JD	1	393	25	4.740	91.70	0.01	YES	YES	
20	845	TH	1	418	25	6.559	209.00	1.11	YES	YES	
21	1200	TH	1	275	25	10.550	422.00	1.3	YES	YES	
22	730	DM	1	OFF	25	85.400	4100.00	4.32	YES	YES	Fall Creek Intakes buried
23	800	DM	1	OFF	25	32.430	645.00	0.04	YES	YES	Fall Creek Intakes buried
24	1605	DM	1	OFF	25	24.110	373.00	0.25	YES	YES	Fall Creek Intakes buried
25	730	JD	1	OFF	25	20.900	297.00	0.34	YES	YES	Fall Creek Intakes buried
26	715	JD	1	OFF	25	17.690	235.00	0.02	YES	YES	Fall Creek Intakes buried
27	1025	DM	1	OFF	25	15.600	195.00	0.01	YES	YES	Fall Creek Intakes buried
28	830	KM	1	OFF	25	15.010	174.00	0	YES	YES	Fall Creek Intakes buried
29	650	JD	1	OFF	25	14.400	155.00	0.01	YES	YES	Fall Creek Intakes buried
30	700	JD	1	OFF	25	13.540	140.00	0	YES	YES	Fall Creek Intakes buried
31	725	DM	1	OFF	25	13.050	129.00	0	YES	YES	Fall Creek Intakes buried

508

Fall Creek Intake February 2024

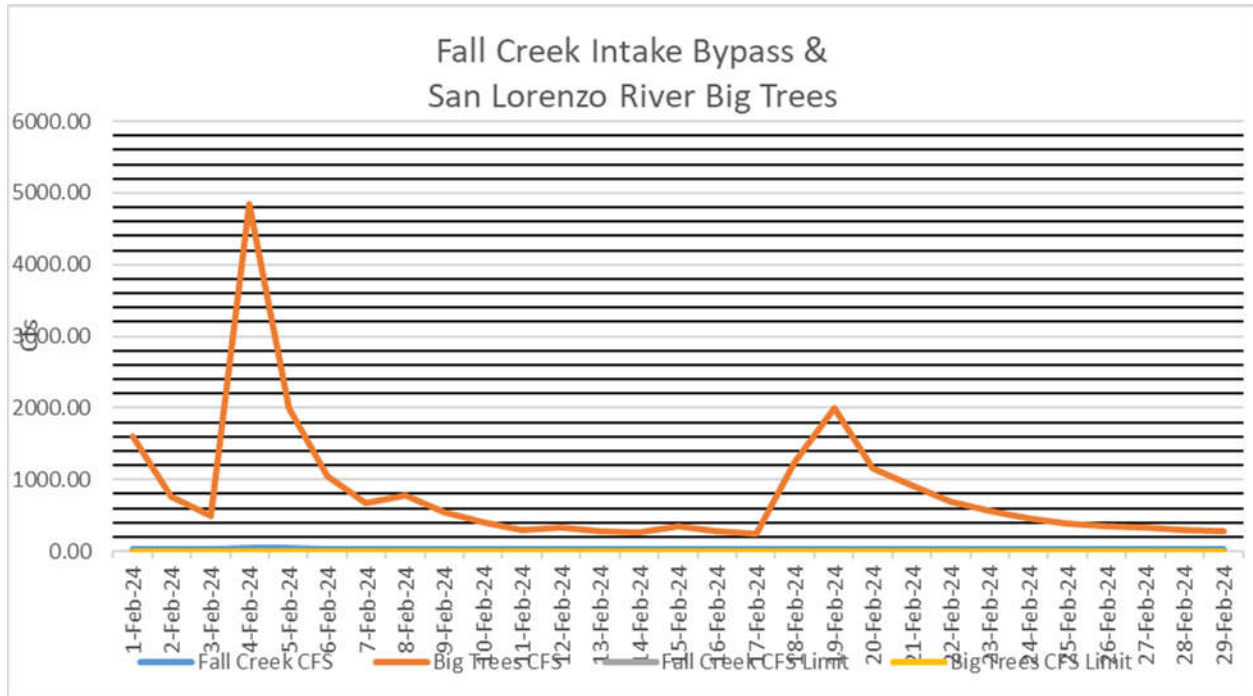

Normal Rainfall Fall Creek Intake Bypass Requirements

April 1 through October 31 1.0 cubic feet per second

November 1 through March 31 1.5 cubic feet per second

Dry Conditions Fall Creek Intake Bypass Requirements

April 1 through October 31 0.5 cubic feet per second

November 1 through March 31 0.75 cubic feet per second

Number of Days in month 0.75 cfs or below, ZERO days

San Lorenzo River USGS Big Trees Flow Requirements

September 11 cubic feet per second

October 26 cubic feet per second

November 1 through May 31 21 cubic feet per second

June - August No Requirements

Fall Creek Intake February 2024

For the protection of fish and wildlife, during the period: (a) April 1 through October 31 bypass a minimum of 0.5 cfs; (b) November 1 through March 31 bypass a minimum of 1.5 cfs past the Fall Creek point of diversion. The natural streamflow shall be bypassed whenever it is less than 1.5 cfs; provided, however, that during a dry year, the bypass requirement shall be reduced from 1.5 to 0.75 cfs. A dry year is defined on a monthly basis of cumulative runoff beginning October 1 of each season in the San Lorenzo River at the USGS gage at Big Trees. These runoff figures are based on approximately 50 percent of normal runoff as the dividing level between normal and dry year runoff and are as follows:

- November 1 for the month of October 500 af
- December 1 for October-November, inclusive 1,500 af
- January 1 for October-December, inclusive 5,000 af
- February 1 for October-January, inclusive 12,500 af
- March 1 for October-February, inclusive 26,500 af

Fall Creek Weir Measurement

Agenda: 4.4.24

Item: 12.4

Month:	February	Year:	2024	Big Trees > 26,500 Acre-ft Oct-Feb Normal Year	Big Trees <26,500 Acre-ft Oct-Feb Dry Year						
				<input checked="" type="checkbox"/>	<input type="checkbox"/>						
Date	Time	Initials	Pump #	Fall Cr. GPM into Kirby plant	Weir Board Height (inches)	Fall Creek Bypass (CFS)	Big Trees Bypass (CFS)	Rainfall (Felton gauge)	Met Fall Cr, Bypass Requirement: Normal Year April 1 - Oct 31 1.0 cfs; Nov 1 - March 31 1.5 cfs Dry Year April 1- Oct 31 0.5 cfs Nov. 1 - March 31 0.75 cfs (yes/no)	Met Big Trees Requirement Nov-May 20cfs Sept 10 cfs Oct 25 cfs (yes/no)	Notes
1	630	JD	1	OFF	25	24.690	1610.00	2.8	YES	YES	Fall Creek Intakes Buried
2	645	JD	1	OFF	25	21.420	758.00	0.98	YES	YES	Fall Creek Intakes Buried
3	830	KM	1	OFF	25	19.530	488.00	0.2	YES	YES	Fall Creek Intakes Buried
4	910	KM	1	OFF	25	45.510	4850.00	3	YES	YES	Fall Creek Intakes Buried
5	920	DM	1	OFF	25	39.840	1990.00	0.56	YES	YES	Fall Creek Intakes Buried
6	715	JD	1	OFF	25	32.850	1050.00	0.18	YES	YES	Fall Creek Intakes Buried
7	730	JD	1	OFF	25	29.650	666.00	0.07	YES	YES	Fall Creek Intakes Buried
8	645	JD	1	OFF	25	30.360	777.00	1.05	YES	YES	Fall Creek Intakes Buried
9	645	JD	1	OFF	25	27.480	545.00	0	YES	YES	Fall Creek Intakes Buried
10	845	TH	1	OFF	25	26.150	397.00	0.01	YES	YES	Fall Creek Intakes Buried
11	1150	TH	1	OFF	25	24.300	303.00	0	YES	YES	Fall Creek Intakes Buried
12	700	JD	1	OFF	25	23.070	324.00	0.01	YES	YES	Fall Creek Intakes Buried
13	700	KM	1	OFF	25	22.050	285.00	0	YES	YES	Fall Creek Intakes Buried
14	700	JD	1	OFF	25	21.510	260.00	0.02	YES	YES	Fall Creek Intakes Buried
15	730	JD	1	OFF	25	23.280	355.00	0.96	YES	YES	Fall Creek Intakes Buried
16	645	JD	1	OFF	25	21.960	277.00	0	YES	YES	Fall Creek Intakes Buried
17	715	JD	1	OFF	25	20.980	250.00	0.01	YES	YES	Fall Creek Intakes Buried
18	630	JD	1	OFF	25	32.340	1240.00	1.7	YES	YES	Fall Creek Intakes Buried
19	900	SB	1	OFF	25	35.810	2000.00	1.8	YES	YES	Fall Creek Intakes Buried
20	745	TH	1	OFF	25	30.970	1150.00	0.05	YES	YES	Fall Creek Intakes Buried
21	800	JD	1	OFF	25	30.000	921.00	0.6	YES	YES	Fall Creek Intakes Buried
22	845	JD	1	OFF	25	28.140	696.00	0	YES	YES	Fall Creek Intakes Buried
23	825	JD	1	OFF	25	27.140	570.00	0	YES	YES	Fall Creek Intakes Buried
24	900	TH	1	OFF	25	26.300	453.00	0	YES	YES	Fall Creek Intakes Buried
25	900	TH	1	OFF	25	25.420	394.00	0	YES	YES	Fall Creek Intakes Buried
26	700	JD	1	OFF	25	24.850	350.00	0	YES	YES	Fall Creek Intakes Buried
27	730	JD	1	OFF	25	24.250	324.00	0.01	YES	YES	Fall Creek Intakes Buried
28	645	JD	1	OFF	25	23.420	292.00	0	YES	YES	Fall Creek Intakes Buried
29	745	JD	1	OFF	25	22.990	272.00	0.06	YES	YES	Fall Creek Intakes Buried

SAN LORENZO VALLEY WATER DISTRICT
MONTHLY LEAK REPORT
March 2024

Agenda: 4.4.24
Item: 12.4

Date	Leak Type	NORTH SYSTEM	Town	Gallons Lost	
Dec-23	400 MAIN LEAKING	417 BAHR DR.	BEN LOMOND	4,500	
Dec-23	400 MAIN LEAKING	130 CALEDONIUM AVE.	BEN LOMOND	2,000	
Dec-23	400 MAIN LEAKING	12704 HWY 9	BOULDER CREEK	2,880	
Dec-23	400 MAIN LEAKING	MEADOW DR	BOULDER CREEK	1,800	
Dec-23	400 MAIN LEAKING	230 ORMAN RD	BOULDER CREEK	2,400	
Dec-23	400 MAIN LEAKING	255 GLENWOOD RD	BOULDER CREEK	4,320	
Dec-23	400 MAIN LEAKING	CLEAR CREEK	BROOKDALE	1,800	
24-Jan	400 MAIN LEAKING	205 COTTAGE AVE.	BEN LOMOND	5,760	
24-Jan	400 MAIN LEAKING	200 CALEDONIUM AVE.	BEN LOMOND	1,200	
24-Jan	400 MAIN LEAKING	1200 DUNDEE AVE.	BEN LOMOND	1,800	
24-Jan	400 MAIN LEAKING	580 DICKINSON AVE.	BEN LOMOND	10	
24-Jan	420 HYDRANT LEAK/REPAIRS	BROOKSIDE	BEN LOMOND	-	
24-Jan	400 MAIN LEAKING	200 CALEDONIUM AVE	BEN LOMOND	20,000	
24-Jan	400 MAIN LEAKING	320 BLUERIDGE DR.	BOULDER CREEK	2,880	
24-Jan	400 MAIN LEAKING	459 RIDGE DR.	BOULDER CREEK	2,880	
24-Jan	400 MAIN LEAKING	13133 HWY 9	BOULDER CREEK	500	
24-Jan	400 MAIN LEAKING	814 CREEK DR	BOULDER CREEK	1,440	
24-Jan	412 TANK LEAKING	ECHO TANK	BOULDER CREEK	5,000	
24-Jan	400 MAIN LEAKING	12245 MONAN AVE.	BROOKDALE	500	
Feb-24	400 MAIN LEAKING	235 VALE WAY	BOULDER CREEK	-	
Feb-24	400 MAIN LEAKING	155 TEILH DR.	BOULDER CREEK	720	
Feb-24	400 MAIN LEAKING	LAUREL AND 236	BOULDER CREEK	8,500.00	
			Total North	70,890.00	
Felton					
Dec-23	400 MAIN LEAKING	1160 LAKESIDE DR.	FELTON	7,200	
Dec-23	400 MAIN LEAKING	9540 E. ZAYANTE	FELTON	1,800	
24-Jan	400 MAIN LEAKING	KIRBY ST	FELTON	79,000	
Feb-24	400 MAIN LEAKING	10830 WEST DR	FELTON	9,000	
Feb-24	400 MAIN LEAKING	5995 PLATEAU DR	FELTON	2,880	
			Total Felton	99,880	
LOMPICO					
Dec-23	400 MAIN LEAKING	LAKESHORE	LOMPICO	-	
Dec-23	400 MAIN LEAKING	12255 LAKE BLVD.	LOMPICO	3,600	
Feb-24	400 MAIN LEAKING	11370 LAKEVIEW AVE.	LOMPICO	7,200	
			Total Lompico	10,800	
SCOTT'S VALLEY					
Dec-23	400 MAIN LEAKING	309 SPREADING OAK DR	SCOTT'S VALLEY	3,960.0	
24-Jan	400 MAIN LEAKING	798 LOCKWOOD LN	SCOTT'S VALLEY	15,000.0	
			Total Scotts Valley	18,960	
				Total All Systems	200,530

						Water Quality Complaint List				System No. 4410014	
Date Received	Type Of Complaint								Address	Conclusion	
	Taste/Odor	Color	Turbidity/Particles	Worms/Other Visible Organisms	Pressure (High/Low)	Illness (Waterborne)	Other (Specify)				
1/8/2024		x							285 Twin Pines, Scotts Valley	Customer complained of brown water. Operator sampled cutomers front hose bib, water was slighty dirty. Staff flushed near by hydrant and customers tap until clear. Cause most likely due to near by main break. NTU-1.90 CL2-1.05ppm	
1/19/2024							x (cloudy water)		12115 Monan Way., Brookdale	Customer complained of cloudy water. Operator sampled front hose bib and found the water to have entrained air. Staff flushed customers hose bib and near by hydrants until all air was relaesed. Cause most likely due to near by main upgrade performed by contractor. NTU-0.443 CL2-0.13ppm	
1/26/2024		x							372 Farmer St., Felton	Customer complained of brown water. Operator sampled front hose bib and found the water to be discolored. Staff flushed customers hose bib and near by hydrants until clear. Cause most likely due to near by main upgrade performed by contractor. NTU-0.80 CL2-0.92ppm	

				Water Quality Complaint List					System No. 4410014
Date Received	Type Of Complaint							Address	Conclusion
	Taste/Odor	Color	Turbidity/Particles	Worms/Other Visible Organisms	Pressure (High/Low)	Illness (Waterborne)	Other (Specify)		
2/7/2024		x						833 Pinecone Dr, Scotts Valley	Customer complained of dirty water. Operator flushed and sampled front hose bib for about 10 min until clear. Operator did find the water to be slightly red with some entrained air. Likely cause was a meter change at this address the day before. CL2-0.52ppm NTU-0.67
2/19/2024		x						12301 Coleman Ave., Felton/Lompico	Customer complained of brown water. Operator flushed and sampled front hose bib for about 45 min until clear. Operator did find the water to be slightly brown. Staff also flushed nearby hydrants until clear. Likely cause was a nearby main break. CL2-0.86ppm NTU-1.46
2/22/2024		x						100 Baja Sol Dr., Scotts Valley	Customer complained of dirty water. Operator flushed and sampled front hose bib for about 10 min until clear. Operator did find the water to be slightly brown. Likely cause was a meter change at this address the week before. CL2- 1.14ppm NTU-1.96

SAN LORENZO VALLEY WATER DISTRICT
VEHICLE MILEAGE
February 2024

Agenda: 4.4.24
Item: 12.4

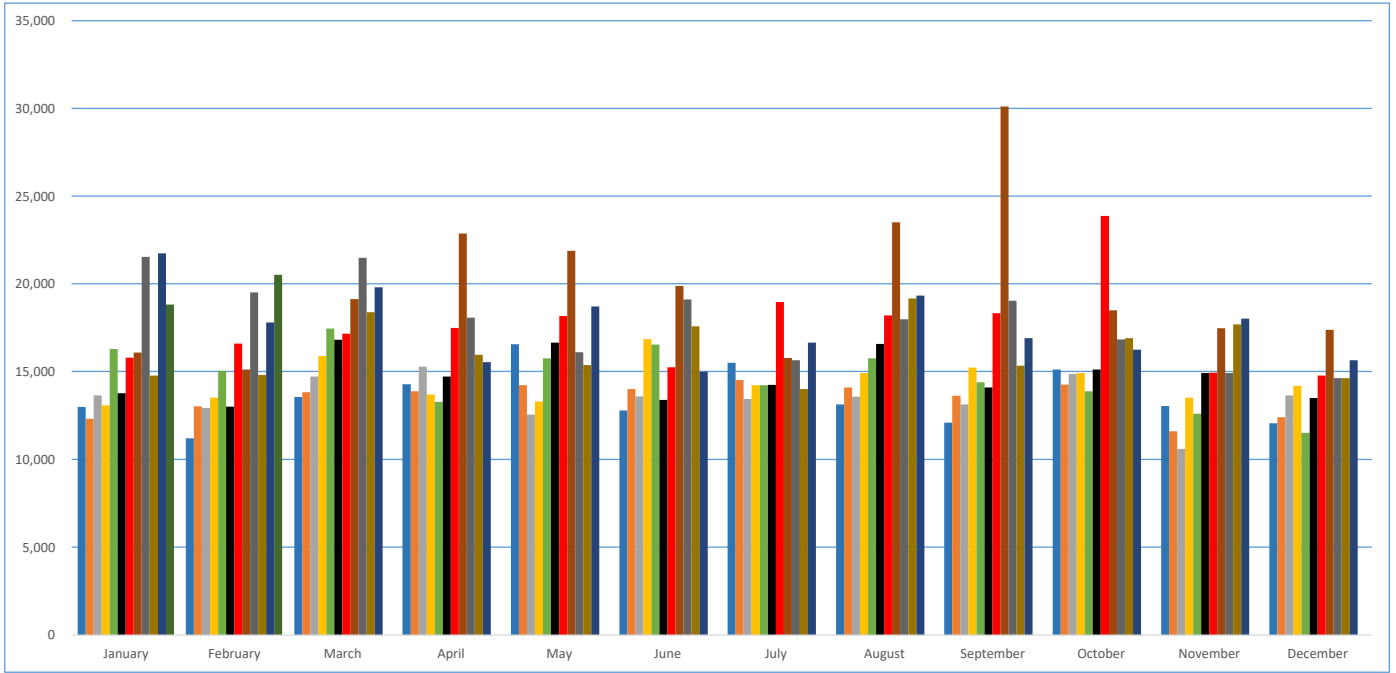

Month	2013	2014	2015	2016	2017	2018	2019	2020	2021	2022	2023	2024
January	12,976	12,317	13,633	13,082	16,286	13,763	15,790	16,088	21,532	14,776	21,727	18,820
February	11,201	13,015	12,934	13,505	15,045	13,003	16,599	15,113	19,513	14,800	17,793	20,518
March	13,558	13,817	14,714	15,882	17,451	16,809	17,167	19,132	21,481	18,377	19,806	
April	14,283	13,883	15,279	13,704	13,270	14,711	17,488	22,868	18,068	15,953	15,539	
May	16,560	14,228	12,550	13,290	15,757	16,646	18,156	21,879	16,099	15,367	18,706	
June	12,780	14,000	13,582	16,841	16,534	13,390	15,249	19,882	19,108	17,584	14,985	
July	15,497	14,519	13,441	14,228	14,229	14,242	18,955	15,775	15,653	14,013	16,641	
August	13,136	14,096	13,569	14,923	15,761	16,576	18,194	23,496	17,973	19,173	19,330	
September	12,087	13,622	13,137	15,229	14,388	14,094	18,321	30,095	19,039	15,342	16,898	
October	15,120	14,261	14,868	14,924	13,880	15,126	23,864	18,486	16,831	16,904	16,255	
November	13,046	11,594	10,591	13,510	12,598	14,908	14,942	17,473	14,914	17,681	18,023	
December	12,060	12,394	13,648	14,187	11,512	13,492	14,763	17,372	14,633	14,630	15,653	
Totals	162,304	161,746	161,946	173,305	176,711	176,760	209,488	237,659	214,844	194,600	211,356	39,338

SAN LORENZO VALLEY WATER DISTRICT
OPERATIONS DEPARTMENT

Agenda: 4.4.24
Item: 12.4

February 2024

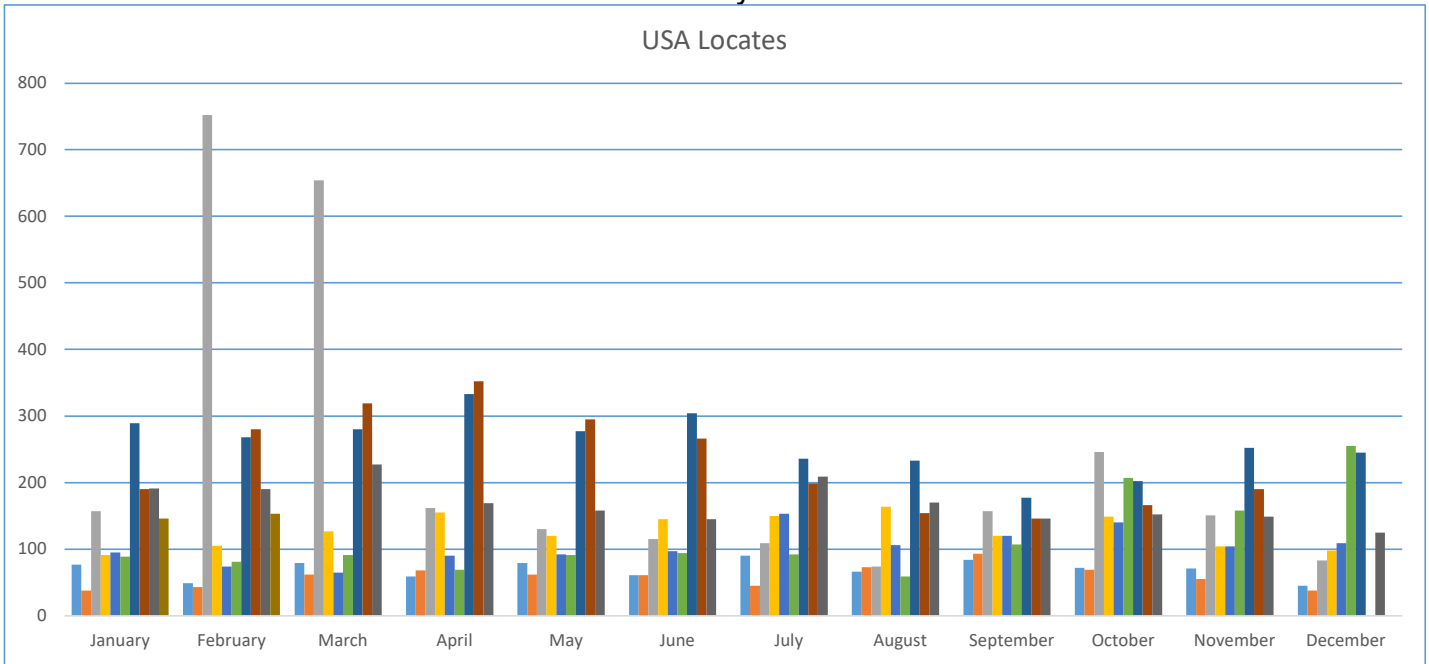

Month	2015	2016	2017	2018	2019	2020	2021	2022	2023	2024
January	77	38	157	91	95	89	289	190	191	146
February	49	43	752	105	74	81	268	280	190	153
March	79	62	654	127	65	91	280	319	227	
April	59	68	162	155	90	69	333	352	169	
May	79	62	130	120	92	91	277	295	158	
June	61	61	115	145	97	94	304	266	145	
July	90	45	109	150	153	92	236	199	209	
August	66	73	74	164	106	59	233	154	170	
September	84	93	157	120	120	107	177	146	146	
October	72	69	246	149	140	207	202	166	152	
November	71	55	151	104	104	158	252	190	149	
December	45	38	83	98	109	255	245		125	
Total	832	707	2,790	1528	1245	1393	3096	2557	2031	299



SAN LORENZO VALLEY WATER DISTRICT

Well Drawdown Report

Olympia 1



Location: 1/8 Mile East of 7701 Zayante Rd.
Elevation: 448' Mean Sea Level
Installed: January 23, 1978
State Well #: 4410014-009
Owners# 73-101-03
Completed Depth: 162'

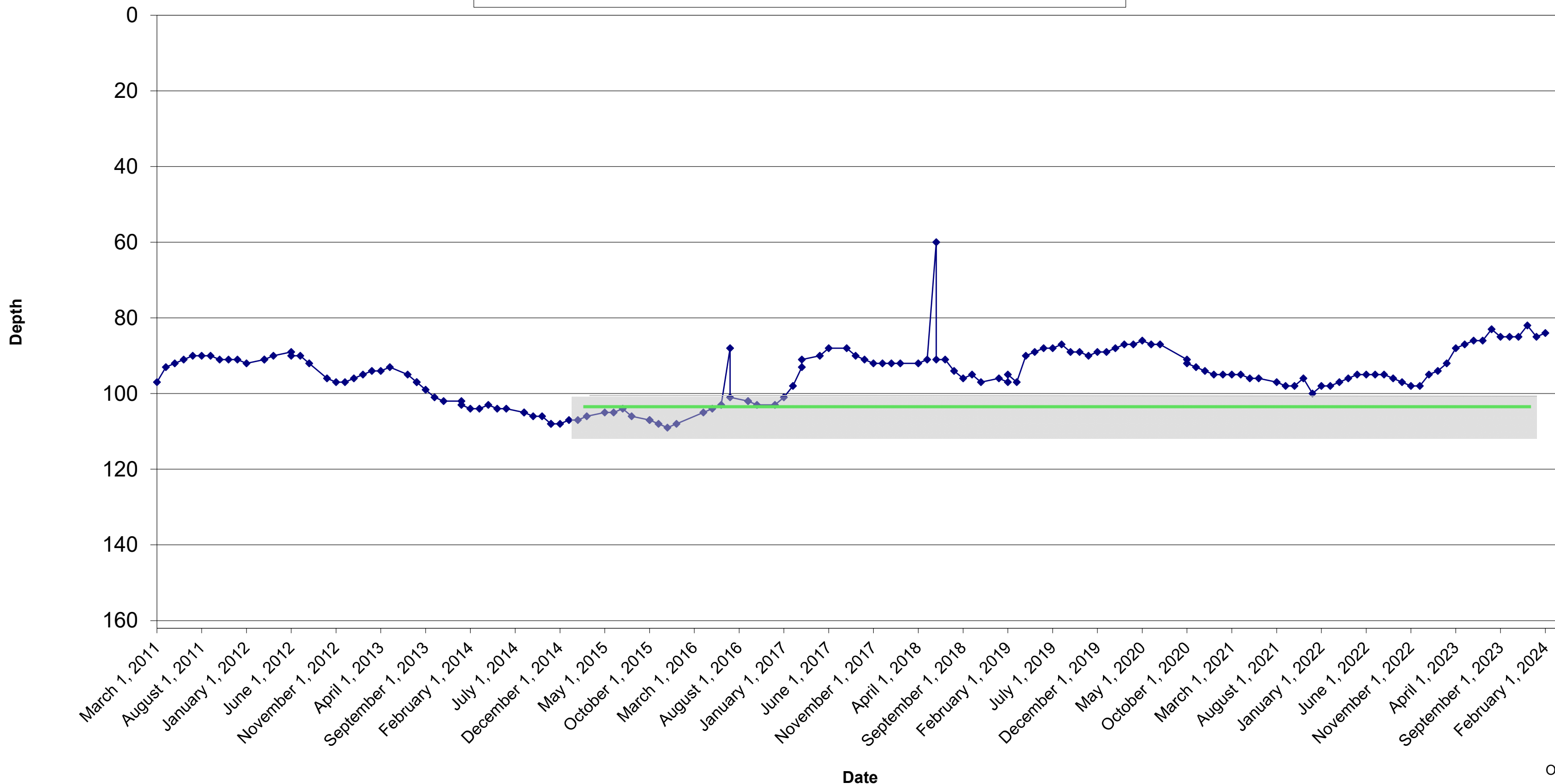



SAN LORENZO VALLEY WATER DISTRICT

Well Drawdown Report

Olympia 2

Location: 7701 E. Zayante Rd.
Elevation: 525'
Installed: April 28, 1980
State Well #: 10S/O2W-11P01
New #: 4410014-010
Completed Depth: 300'

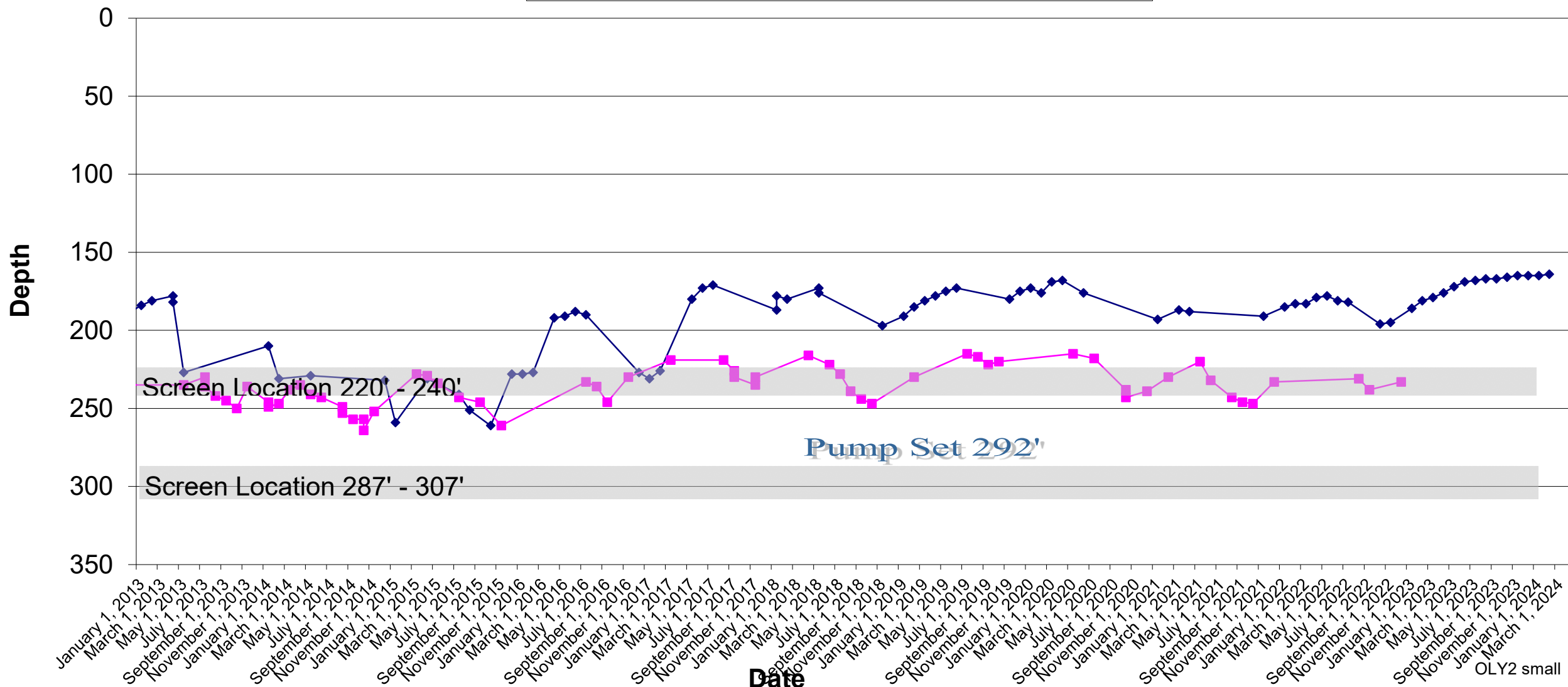
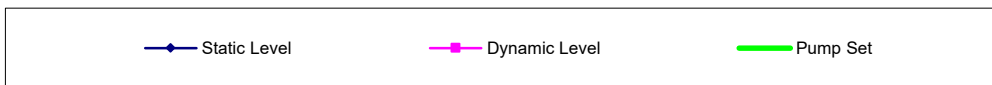



SAN LORENZO VALLEY WATER DISTRICT

Well Drawdown Report

Olympia 3

Location: 7701 E. Zayante Rd
Elevation: 538' Mean Sea Level
Installed: 8-15-90
State Well #: 4410014-022
Completed Depth:

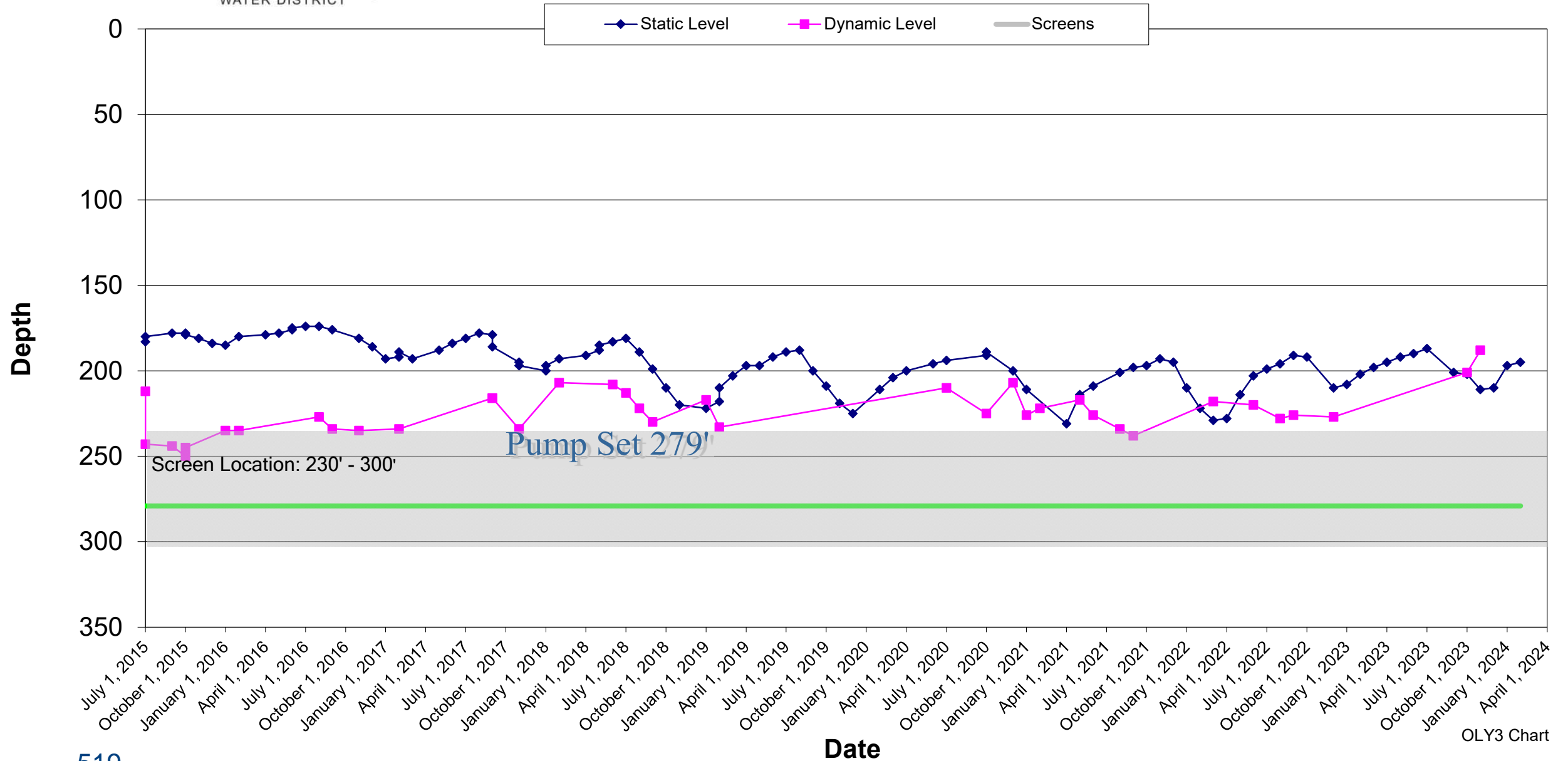

SAN LORENZO VALLEY WATER DISTRICT

Well Drawdown Report

Olympia 1



Location: 1/8 Mile East of 7701 Zayante Rd.
Elevation: 448' Mean Sea Level
Installed: January 23, 1978
State Well #: 4410014-009
Owners# 73-101-03
Completed Depth: 162'

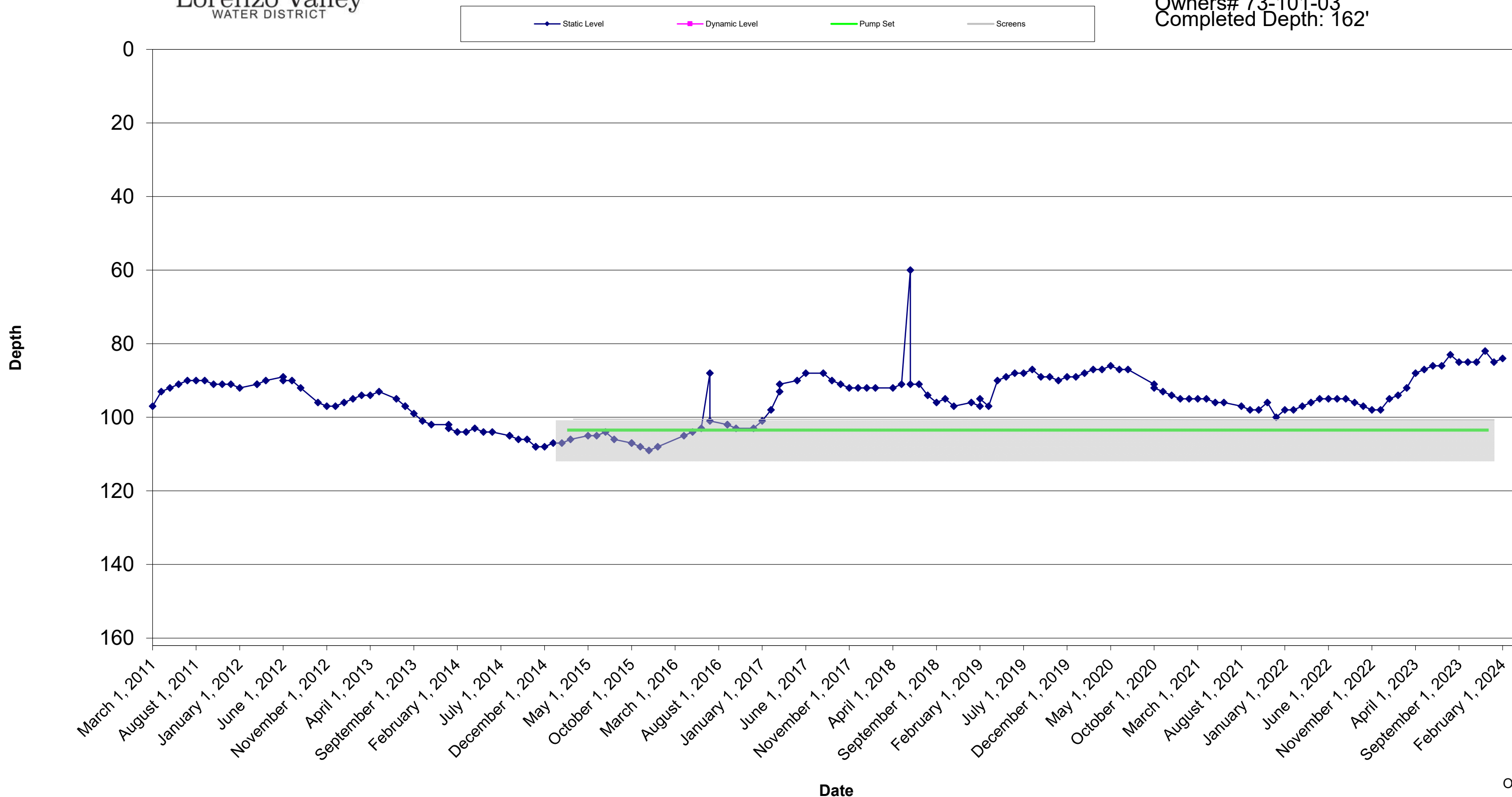



SAN LORENZO VALLEY WATER DISTRICT

Well Drawdown Report

Pasatiempo 5-A

Location: So. Of 3650 Graham Hill Rd
Elevation: 752'
Installed 1-1-14
State Well #:4410014-014
Completed Depth: 710'

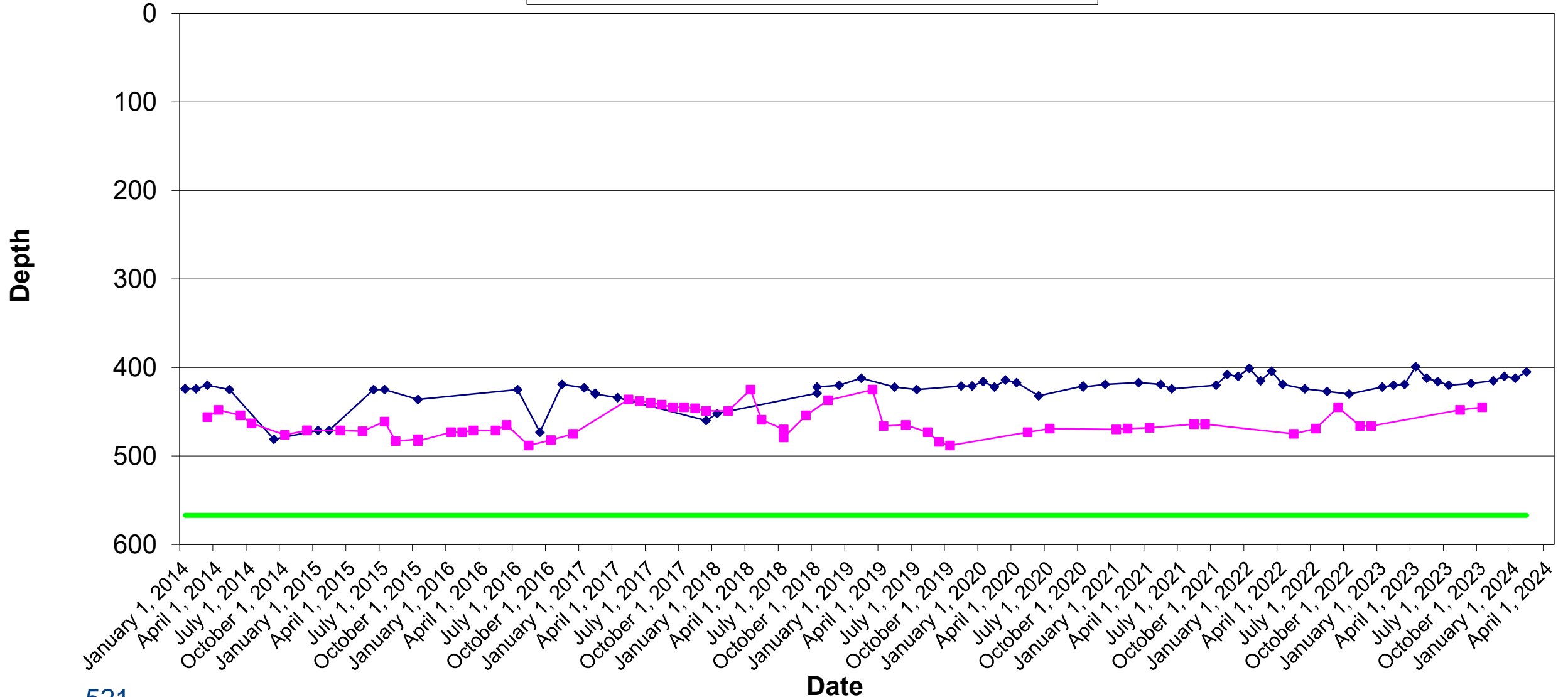



SAN LORENZO VALLEY WATER DISTRICT Well Drawdown Report Pasatiempo 7

Location: South of Probation Center
Elevation: 734' MSL
Installed: July 21, 1990
State Well #: 4410014-024
Completed Depth: 540'

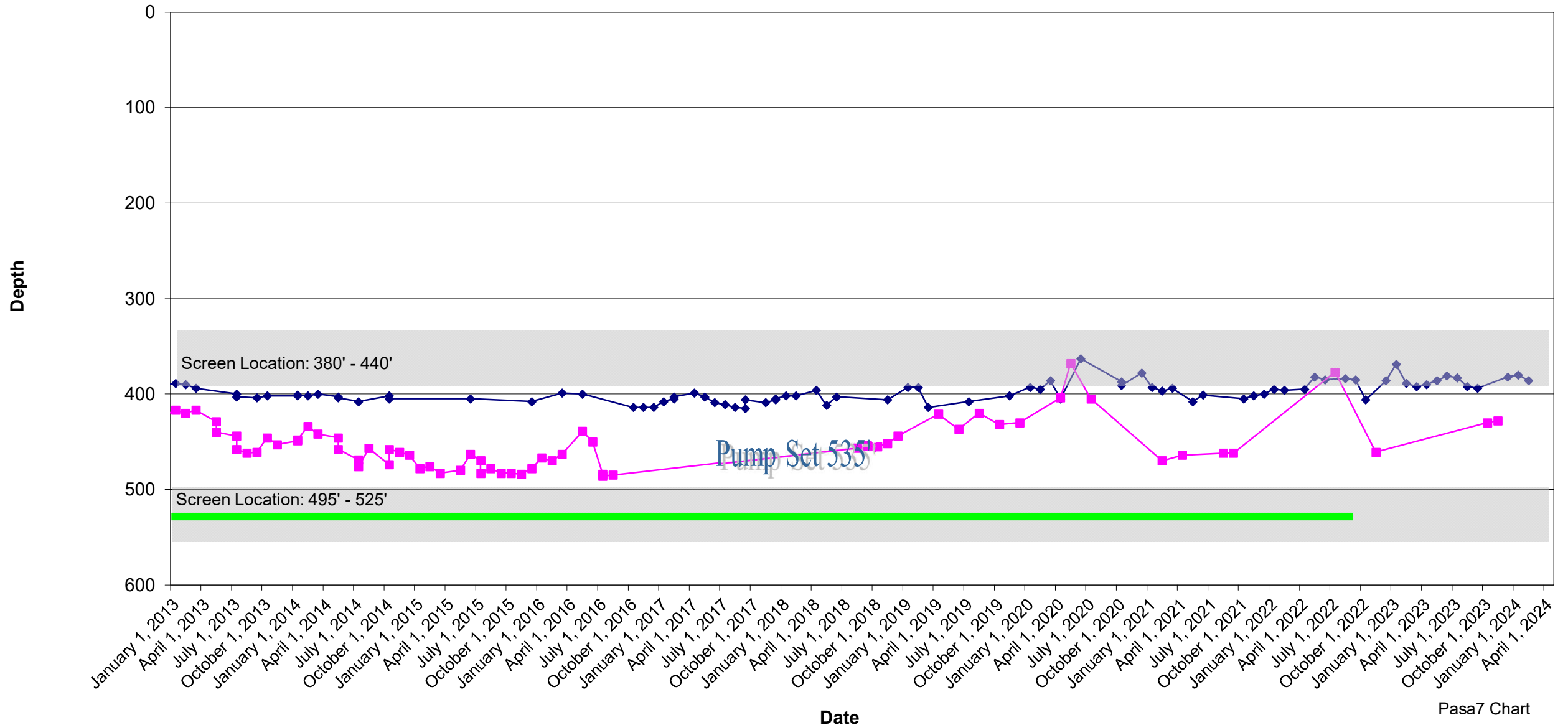
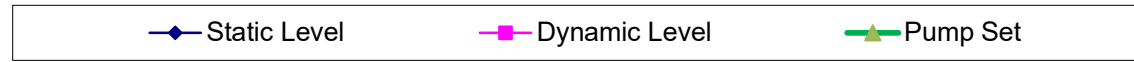



SAN LORENZO VALLEY WATER DISTRICT

Well Drawdown Report

Pasatiempo 8

Location: Behind 3650 Graham Hill Rd.
Elevation: 775'
Installed: 11-20-2019
State Well #: 4410014-041
Completed Depth: 805'

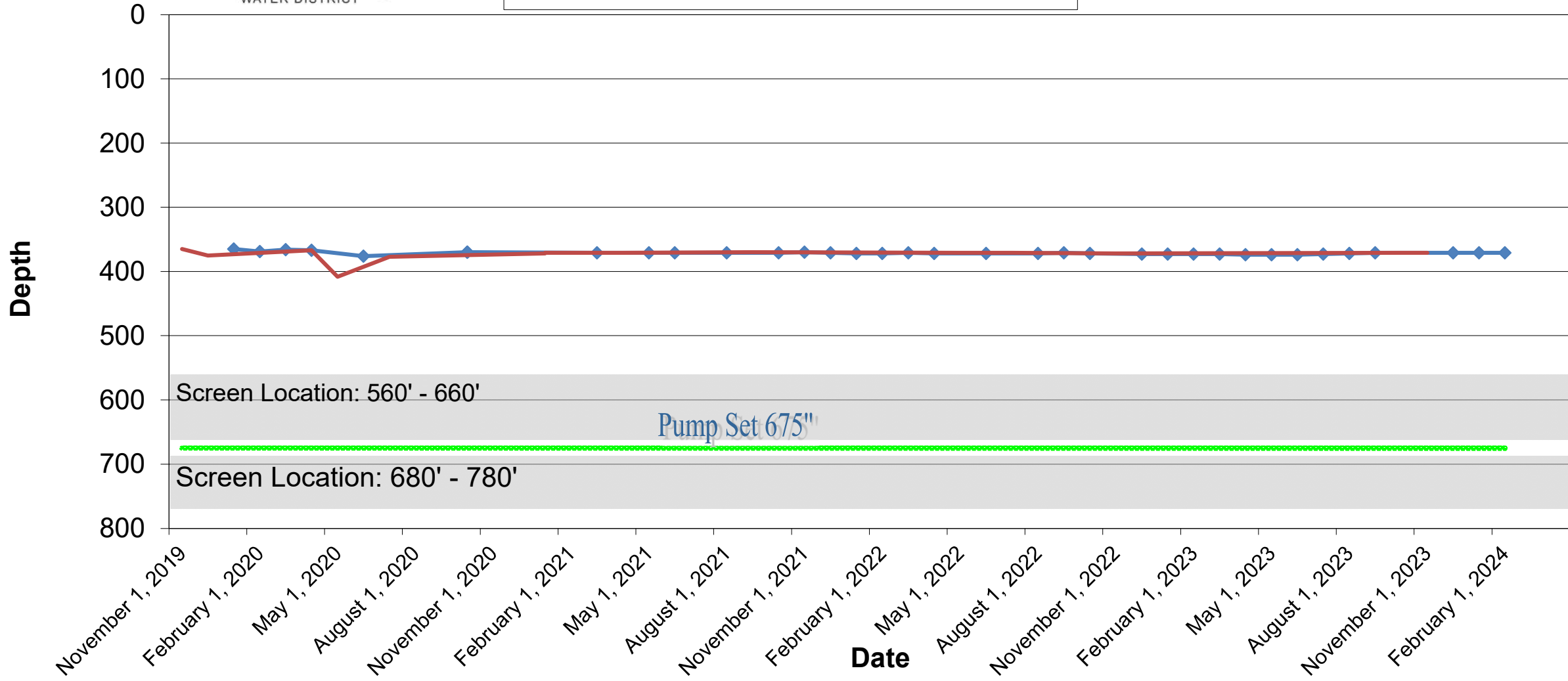



SAN LORENZO VALLEY WATER DISTRICT

Well Drawdown Report

Pasatiempo Monitoring Well 1

Location: Behind 3650 Graham Hill Rd
Elevation: 775'
Installed: 4/91
State Well #: N/A
Completed Depth: 780'
Lompico Sandstone

◆ Static Level

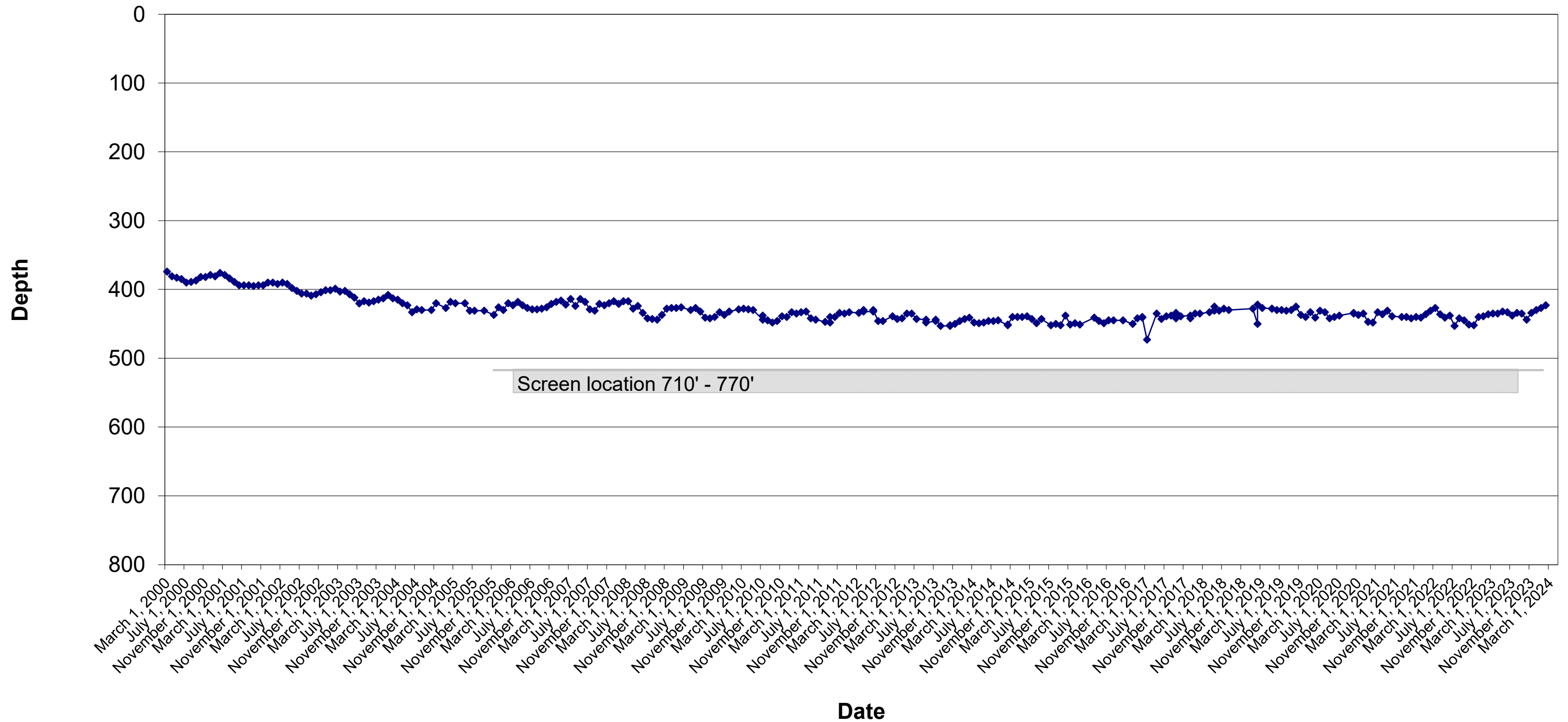



SAN LORENZO VALLEY WATER DISTRICT

Well Drawdown Report

Pasatiempo Monitoring Well 2

Location: Behind 3650 Graham Hill Rd.
Elevation: 775'
Installed: 4/91
State Well #: N/A
Completed Depth: 350'
Santa Margarita Sandstone

◆ Static Level

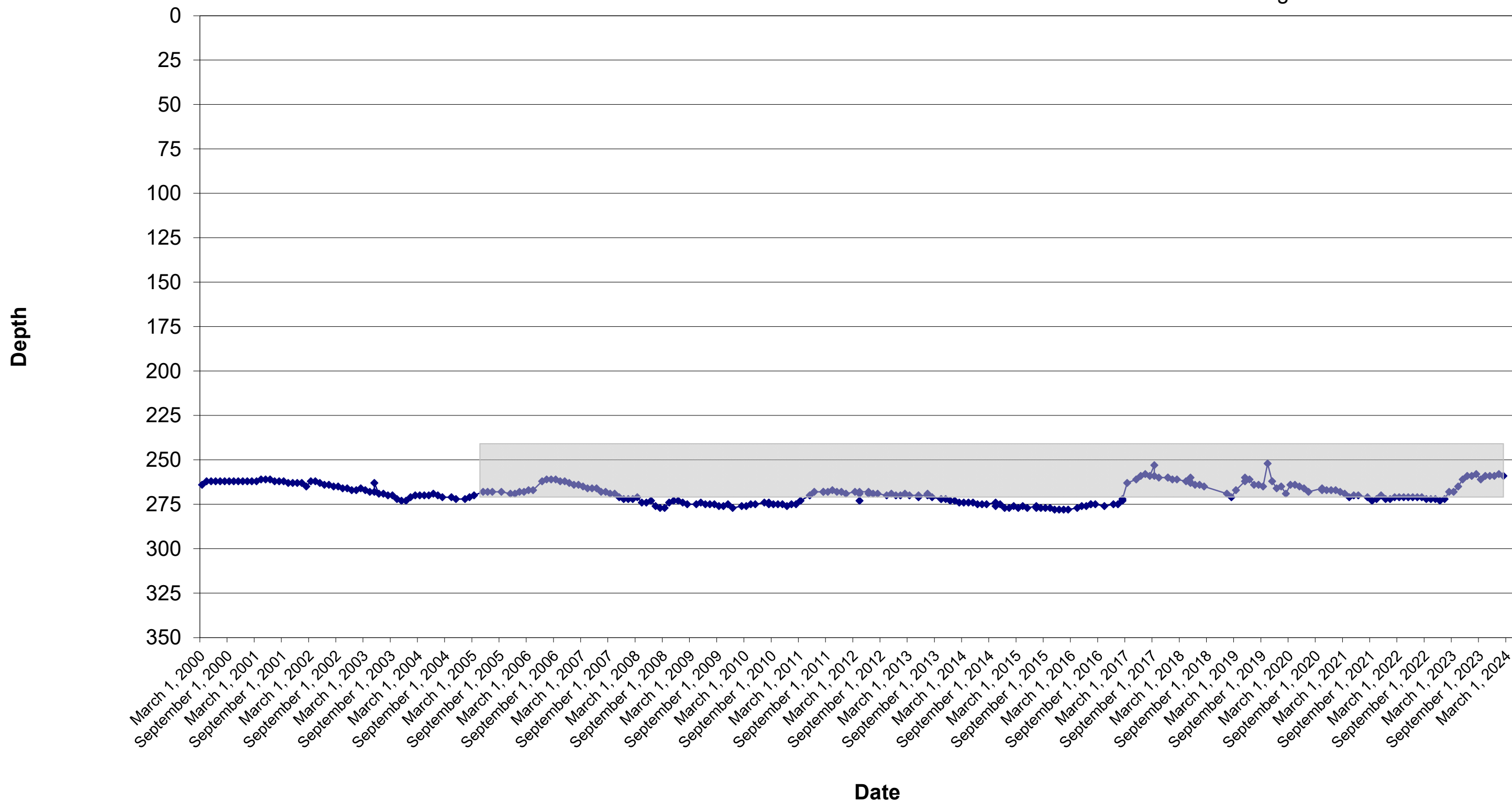



SAN LORENZO VALLEY WATER DISTRICT

Well Drawdown Report

Quail Well 4-A

Location: Cumora Ln. Ben Lomond
Elevation: 596.54 ft @ Pad
Installed: 6-07-2001
State Well #: 4410014-026
Completed Depth: 265

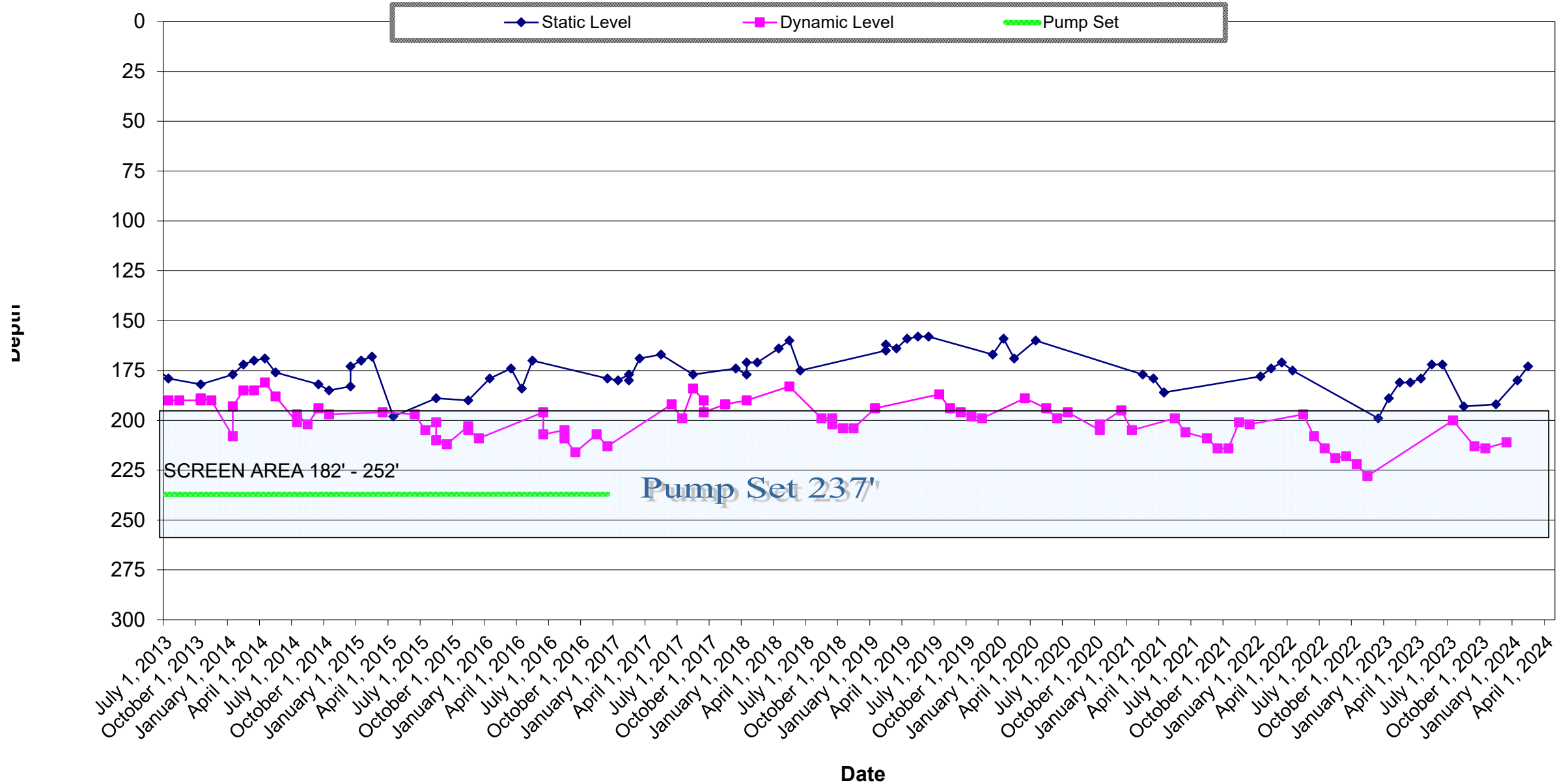

SAN LORENZO VALLEY WATER DISTRICT

Well Drawdown Report

Quail Well 5-A



Location: 1161 Quail Hollow Rd.
Ben Lomond
Elevation: 517.65 ft. @ Pad
Installed: March 2000
State Well #: 4410014-025
Completed Depth: 174'

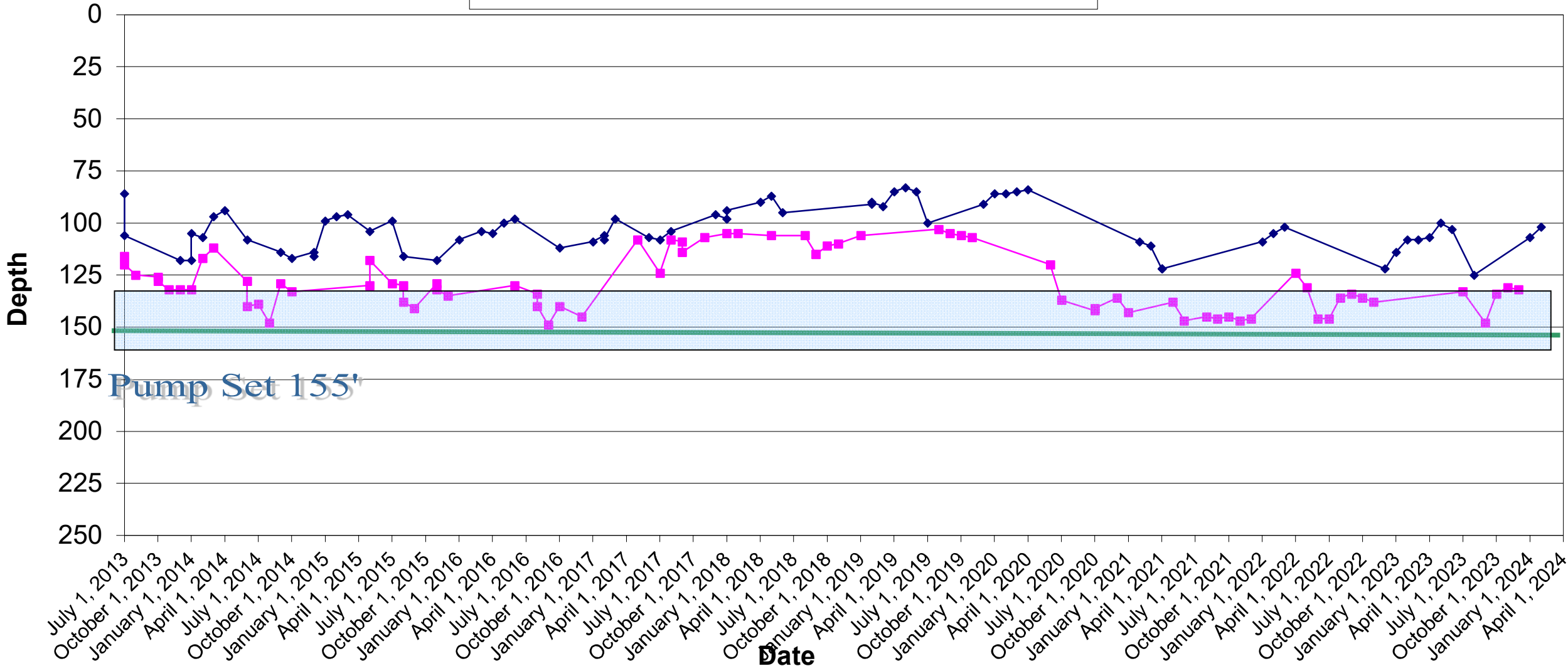

Pump Set 155'



SAN LORENZO VALLEY WATER DISTRICT

Well Drawdown Report

Quail Monitoring Well A

Location: North of Quail Hollow Rd.
Near Santa Cruz Aggregate
Elevation: 425' MSL
Installed:
State Well #:
Completed Depth:

◆ Static Level

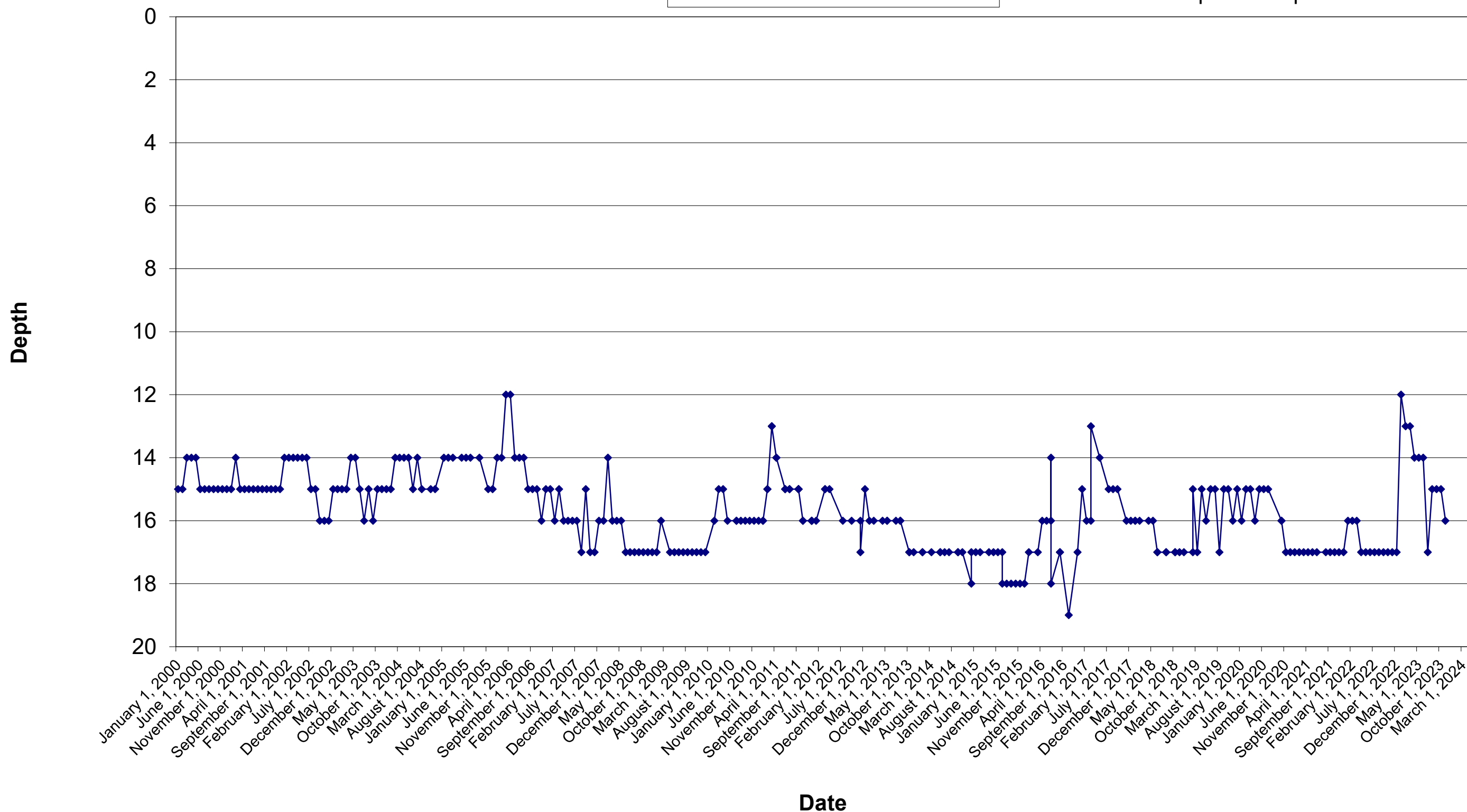



SAN LORENZO VALLEY WATER DISTRICT

Well Drawdown Report

Quail Monitoring Well B

Location: West of Quail Hollow Rd.
Near Quail Hollow Ranch Entrance
Elevation: 593 ' MSL
Installed:
State Well #:
Completed Depth:

◆ Static Level

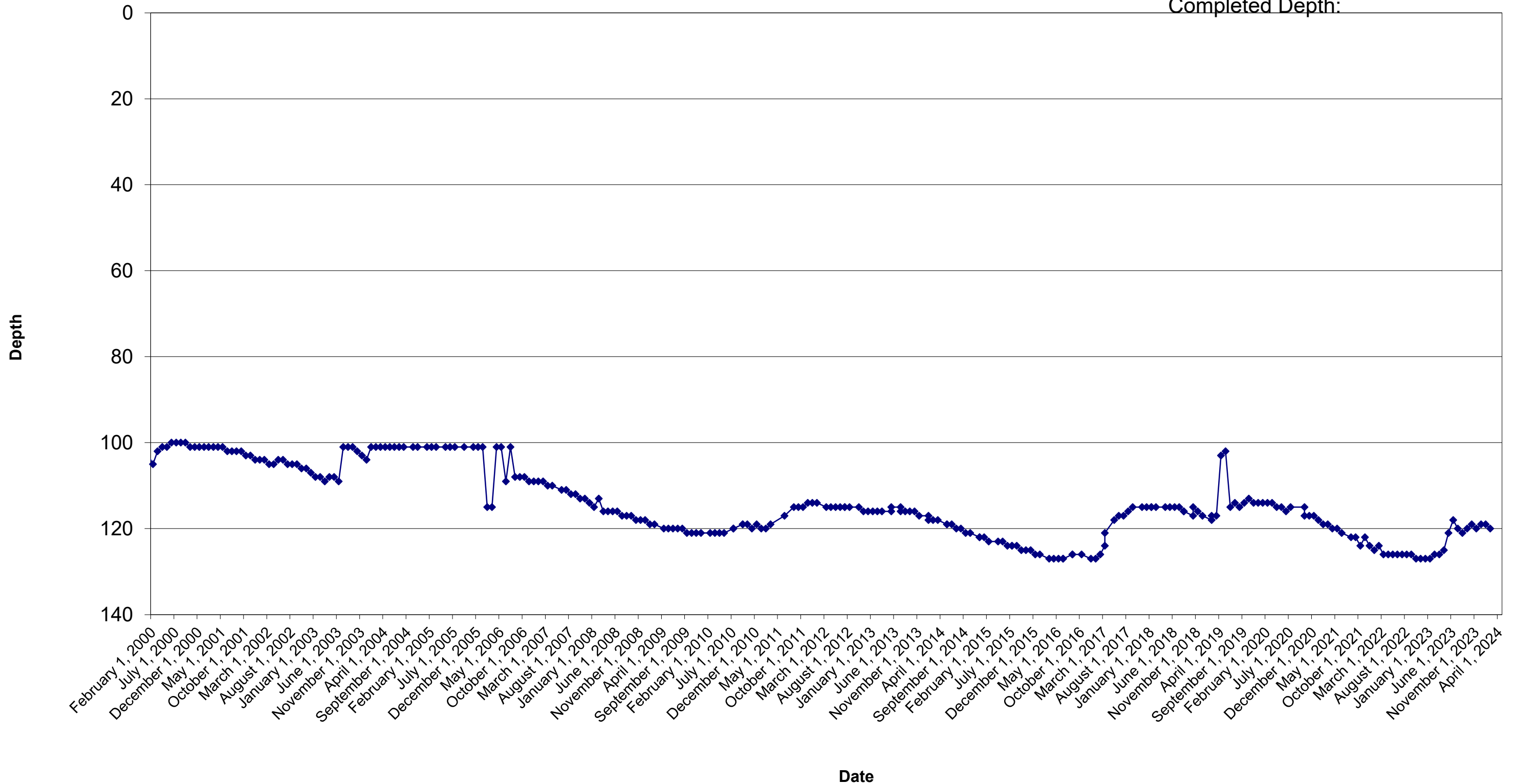



SAN LORENZO VALLEY WATER DISTRICT

Well Drawdown Report

Quail Monitoring Well C

Location: Top of Hill North of Quail Hollow Rd.
Elevation: 650' Mean Sea Level
Installed:
State Well #:
Completed Depth:

◆ Static Level

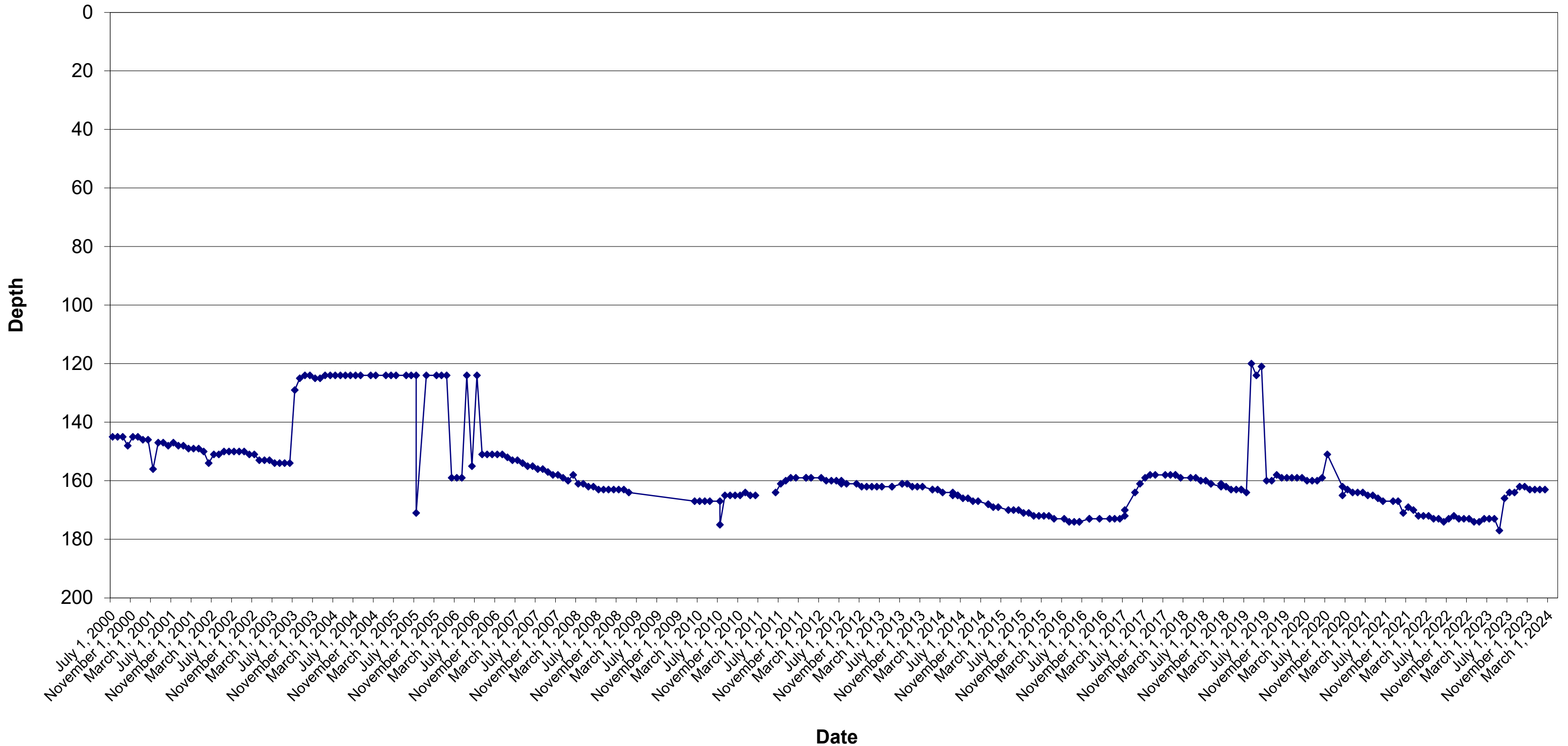

DATE: April 4, 2024
TO: Board of Directors, San Lorenzo Valley Water District
FROM: Brian Frus, Interim General Manager
SUBJECT: General Manager's Report - First Quarter, 2024

WRITTEN BY: Brian Frus, Interim General Manager
PRESENTED BY: Brian Frus, Interim General Manager

STAFF RECOMMENDATION

The Board of Directors accepts the General Manager's report for the First Quarter, of 2024.

PAST QUARTER ACTIVITIES

System-wide Flushing

- Flushing activities commenced in the North System on March 11, 2024, and are scheduled to conclude on May 23, 2024, in Manana Woods.
- To date, inquiries received primarily concern the duration of the flushing process, with no reports of complaints.

2023 Rate Study

- On February 15, revised rates were officially approved, following a public outreach event held on January 20. The process culminated with a coordinated effort that engaged various departments including legal, environmental, engineering, operations, finance, and customer service. Additionally, consultant support was enlisted for technical analysis, presentations, and educational outreach, contributing to the final process.

- Implementation of required billing changes for new rates in progress to meet April billing cycles. This involves collaboration between finance and customer service with support from Raftelis and Miller Maxfield.
- Development of wholesale intertie rates in progress to address situations in which recipients are not part of the District nor contribute property tax revenue.

Compensation Study

- The agreement was approved by the Board on February 15.
- A kickoff meeting was held on March 20.
- Staff are currently in the process of collecting the information requested by the consultant.

Budget Review and Reconciliation

- Completed review of all funding sources associated with Capital Improvement Projects.
- Completed the first phase of project prioritization.

CIP Project Advancement

- District goals are centered on advancing core priority projects.
- Establishing milestones to ensure funding deadlines are met.
- Templates have been developed to effectively manage contract change orders and agreement amendments.

Big Basin Water Company

- BBWC receivership to receive state-funded grant assistance obtained by the County.
- District staff to continue communications with County and BBWC receivership to coordinate future efforts.

Bracken Brae and Forest Springs Consolidation

- Both mutuals have received draft pre-consolidation terms.
- The emergency intertie connection with Bracken Brae has been successfully completed.
- Multiple meetings have been convened to reach a consensus on a revised project scope, cost-sharing arrangements, and agreement terms.
- The District intends to advance elements of the project that can be funded entirely by the Department of Water Resources Small Community Drought Relief Program award of \$3.2 million.
- Staff has completed the State Revolving Fund application process.

Emergency Planning

- Recently participated in supply chain management simulation exercises.
- The concept is integral to regional emergency preparedness planning efforts.
- Regional water managers group to discuss how to optimize resource sharing during major disasters.

LOOK AHEAD TO NEXT QUARTER

Rates

- Complete the development of wholesale intertie rates and assess special case scenarios within the framework of the new rate model designed for the District.

Bracken Brae and Forest Springs Consolidation

- Execute pre-consolidation agreements.
- Finalize project plans and solicit bids for initial construction work.
- Continue efforts to secure additional funding sources.

Capital Improvement Projects

- Assess staffing needs for future requirements.
- Maintain timelines for priority projects.

Conjunctive use

- Commence a comprehensive analysis of seasonal water balance.
- Initiate discussions and planning.

Compensation Study

- Execute agreement, formulate working group, and commence study.
- Anticipate completion by June 2024.

Staffing

- Finance Manager - Conduct interviews and onboard potential candidate for the position.
- District Secretary - The first round of interviews was completed, with the final selection imminent.
- Ongoing evaluation of potential staffing needs and adjustments.



BUDGET & FINANCE COMMITTEE MINUTES MARCH 13, 2024

Wednesday, March 13, 2024, 2:00 p.m., SLVWD Conference Room, 12788 Highway 9, Boulder Creek, and via video/teleconference.

MINUTES

1. **Convene Meeting:** 2:00 p.m.
Roll Call

Committee Members - Present

Gail Mahood, chair
Jeff Hill
Jim Bahn
Skye Herrick

Staff - Present

Brian Frus, General Manager
Heather Ippoliti*, Interim Director of Finance and Business Services
Scott Mattoch, Network Specialist
Holly Hossack, District Secretary

*attended virtually

2. **Oral Communications:**

B. Holloway, Boulder Creek, addressed the Committee.

3. **New Business:**

- a. WHOLESALE INTERTIE RATES
B. Frus introduced and explained this item.

Discussion by the Committee regarding:

- For emergency interties only
- Property taxes paid to the District
- Based on residential rates
- Not regulated by Prop 218 process
- How much difference will this make to the District?

- Will it affect amount charged to SVWD?
- Big Basin agreement
- Emergency intertie definition
- Calculated fixed costs plus taxes received
- Volumetric compared to commercial rate

B. Holloway addressed the Committee.

A motion was made and seconded for the Committee to recommend to the Board adoption of the proposed Wholesale Intertie Rates.

The motion passed unanimously.

- b. MID-YEAR FISCAL REPORT 2023-24
H. Ippoliti introduced and explained this item.

Discussion by the Committee regarding:

- Arbitrage-yield restricted account calculation
- Penalty is the arbitrage tax
- Santa Cruz County vs. T-bills - liquidity
- Fish Ladder was the largest expense
- Unrestricted and restricted bond proceeds
- FEMA funding
- Fire surcharge automatically stops @ \$5 million
- Best practices to spend down the oldest first

A motion was made and seconded to direct staff to transfer the debt proceeds to a yield restricted investment once they become available without penalty and to fully spend down the 2020 Revenue Certificates for Participation Bonds prior to using the 2021 Installment Loan funds on the currently budgeted debt funded projects.

B. Holloway, Boulder Creek, addressed the Committee.

The motion passed unanimously.

The Committee took a 4-minute break 3:29 - 3:33 p.m.

4. **Unfinished Business:**

- a. FINANCE DIRECTOR RECRUITMENT UPDATE
B. Frus introduced and explained this item.
- b. COMPENSATION STUDY UPDATE
B. Frus introduced and explained this item.

5. Adjournment: 3:41 p.m.



MINUTES OF ENGINEERING/ENVIRONMENTAL COMMITTEE MEETING MARCH 19, 2024

Tuesday, March 19, 2024, 2:00 p.m., SLVWD Conference Room, 12788 Highway 9, Boulder Creek, and via video/teleconference.

MINUTES

1. **Convene Meeting:** 2:00 p.m.
Roll Call

Committee Members present

Mark Smolley, Chair
Jeff Hill
Ken Lande
Jeff Schmelter

Staff present

Brian Frus, Interim General Manager
Carly Blanchard, Environmental Programs Manager, Admin Analyst
Chris Klier, Environmental Planner I
Garrett Roffe, Engineering Manager
Scott Mattoch, Network Specialist
Holly Hossack, District Secretary

2. **Oral Communications:** None

3. **New Business:**

- a. PEAVINE PIPELINE REPLACEMENT PROJECT SUMMARY AND CALIFORNIA CONSERVATION CORPS (CCC) CONTRACT
C. Blanchard introduced this item. C. Blanchard and C. Klier presented.

Discussion by the Committee regarding:

- Timing for FEMA payments
- Liability
- Gant chart
- "Removal" change to mitigation
- Costs alignment

- Pipe costs
- Professional Forester/Project Manager on site
- Pipeline fusing and testing
- Wenchers
- Timing for CCC crews tree mitigation
- Permits not needed for tree mitigation

A motion was made and seconded that the Committee recommends the Board to enter into a contract with the California Conservation Corps for Hazardous Tree Mitigation.

The motion passes unanimously.

4. **Unfinished Business:**

a. ENGINEERING PRIORITY PROJECT LIST

Discussion by the Committee regarding:

- Big Basin/Forest Spring construction projects in 2 phases
- Bandwidth of projects
- Priority listing of projects
- 5 tank sites

b. ENVIRONMENTAL PRIORITY PROJECT LIST

Discussion by the Committee regarding:

- Conservation Plan for the Sand Hills
- Conjunctive Use Plan for the Loch Lomond

5. **Adjournment:** 3:34 p.m.



MINUTES OF ADMINISTRATION COMMITTEE MEETING MARCH 27, 2024

Wednesday, March 27, 2024, 3:00 p.m., SLVWD Conference Room, 12788 Highway 9, Boulder Creek, and via video/teleconference.

MINUTES

1. **Convene Meeting: 3:00 P.M.**
Roll Call

Committee Members Present

Dir. Ackemann, chair

Dir. Fultz

Mark Dolson

Staff Present

Brian Frus, General Manager

Holly Hossack, District Secretary

Scott Mattoch, Network Specialist

2. **Oral Communications: None**

3. **New Business:**

- a. BOARD POLICY MANUAL 2024

B. Frus introduced and explained this item. The Committee agreed to end this discussion at 3:30 p.m. in order to get to all of the items on this agenda. This item will be brought back to the Committee until it is completed.

Discussion by the Committee regarding:

- Staff edits to the BPM
 - Page 44 of the agenda 8 A) The deadline for submittal of an agenda item including any written backup material by a Director shall be one week before the Friday preceding the scheduled Board of Directors meeting which is 13 days prior to the meeting date at 5:00 p.m. at the office of the District Secretary. - agreed to by the Committee
 - Page 47 of the agenda 9 F) To promote orderly discussion of the issues before the Board of Directors, for each item of

business, the Chairperson shall typically conduct discussion in the following order: staff presentation, if any; followed by an opportunity for questions by each Director; public comments; an opportunity for comment by each Director; then a request by the Chairperson for a motion, if appropriate. A motion requires a second. A seconded motion may be followed by an additional opportunity for comment if requested by one of the Directors before the Chairperson calls for a vote. - agreed to by the Committee.

- Page 51 of the agenda 9 L) 3. In addition, members of the public may address each agenda item before the Board's decision or vote on that item, including items on the Consent Agenda. & 9 M) Any item on the Consent Agenda will be moved to the regular agenda upon request from an individual Director. Items remaining on the Consent Agenda may be expedited by assuming unanimous consent of the Board of Directors with a request by the Chairperson for a motion seconded by one of the Directors, followed by a call for a vote by the Chairperson and a majority vote by the Board. -the Committee wants these two items rewritten to harmonize with one another. Rewrite the preamble to the Consent Agenda to include: Any item on the Consent Agenda will be moved to the regular agenda upon request from an individual Director. Members of the public may comment on the Consent Agenda and it is at the discretion of the chair or members of the Board to pull that item if they so choose, for discussion.

The Committee will re-visit this item at the next meeting of the Admin Comm and start with page 54 of this agenda item combining comments by members of the Committee and adding them to this document.

- b. COMMUNITY PARTICIPATION FLYER 2024
H. Hossack introduced and explained this item.

Discussion by the Committee regarding:

- Update with Best Practices
- Be more specific - use BPM as a template
- Share on website, on social media, at meetings
- Make a poster for the wall as well as a flyer
- Help understand
 - When to contact the Board
 - When to contact the staff
 - When to go to social media

- c. REVISIT DATE OF ADMINISTRATION COMMITTEE MEETINGS
H. Hossack introduced and explained this item.

Discussion by the Committee:

- The Committee agreed to move the Admin Committee meetings to the third Wednesday at 3:00. The next meeting will be on April 17th.

4. **Unfinished Business:** None

5. **Adjournment:** 4:06 p.m.